

KATALOGU **HIDROSISTEM** 2025



www.hidrosistem.al
contact@hidrosistem.al
info@hidrosistem.al

- **Panele Diellore**
- **Ngrohje & Ftohje**
- **Hidraulike**
- **Hidrosanitare**
- **Aksesore të ndryshëm**

PO KËRKON PANEL DIELLOR?

ATËHERË ZGJIDH MË TË MIRIN

5 VITE
GARANCI

CILËSIA
PREMIUM

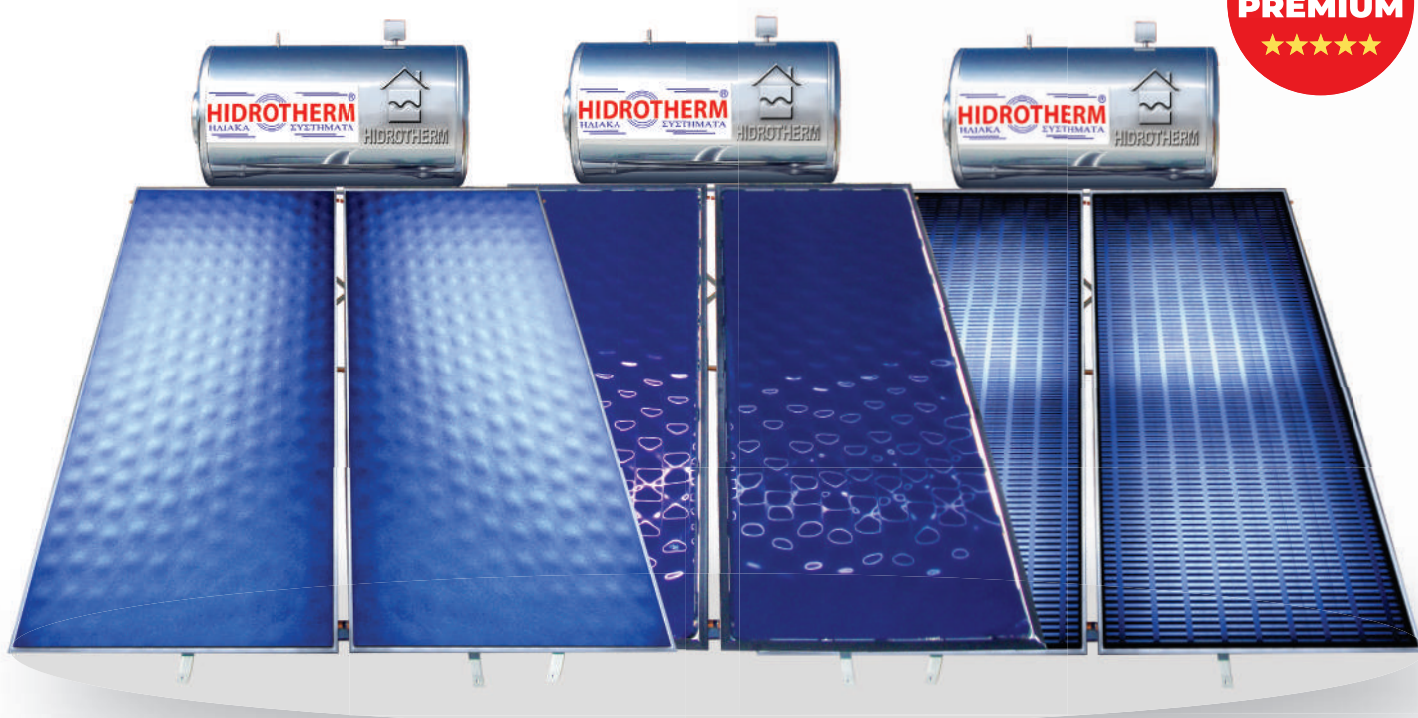

 **HIDROSISTEM**[®]
SISTEME NGROHJE & FTOHJE

HIDROTHERM[®]
ΗΛΙΑΚΑ ΣΥΣΤΗΜΑΤΑ

 hidrosistem

 hidrosistem_albania

HIDROTHERM[®]
ΗΛΙΑΚΑ ΣΥΣΤΗΜΑΤΑ

DAIKIN

APE[®]
RACCORDERIE

FAR
flow evolution

CherBros
more than fittings

Hidroflex

Roca

wilo

magnaplast

XTRON
Air Conditioner

DEM M
RUBINETTERIA
MADE IN ITALY

MELCO

ROTHENBERGER

PEŠTAN
we build trust

bonomi

SOLIN[®]
EST 1986

VIKOTERM
electronic

F **Faso-plast**[®]

ATUSA

TEA

International Drops
Componenti trattamento acqua
Water treatment products

Ecofer
SOLAR THERMAL INDUSTRY

MOBIAK[®]
FIREFIGHTING • GASES • MEDICAL est. 1977

Vidoflex[®]
YOUR INSULATION SUPPLY PARTNER

SPEK

elentek[®]

HydroBOS

THERMIKI
TSALIKIS

PASQYRA E PËRMBAJTJES

MARKA	PËRSHKRIMI	FAQA
HIDROTHERM	PANELET DIELLORE	9
HIDROTHERM	BOLIERËT	13
HIDROTHERM	PASQYRAT E PANELEVE DIELLORE	14
HIDROTHERM	KAMBALECA	15
HIDROTHERM	KAMBALECA PASQYRASH, AKSESORE	16
HIDROTHERM	BOLIERË PËR HOTELERI	17
HIDROTHERM	BOLIERË ELEKTRIK	20
ELCO	DUSH ELEKTRIK	23
ELCO	BOLIER ELEKTRIK 45-120 LT	29
ELCO	AKSESORË	30
DAIKIN	MONO-SPLIT	32
DAIKIN	MONO-SPLIT/MULTI-SPLIT	35
DAIKIN	MULTI-SPLIT	40
DAIKIN	MONO-SPLIT /MULTI-SPLIT	43
DAIKIN	MULTI-SPLIT	44
DAIKIN	MULTI-SPLIT NJËSI E JASHTME	45
DAIKIN	FAN COIL - MURAL	46
DAIKIN	FAN COIL - TOKËSOR	47
DAIKIN	FAN COIL - INKASO	49
DAIKIN	FAN COIL - E FSHEHUR	50
DAIKIN	CHILLER	51
DAIKIN	VRV - MURALE	55
DAIKIN	VRV - TOKËSORE	57
DAIKIN	VRV - TAVANORE	58
DAIKIN	VRV - KASETE	64
DAIKIN	VRV - KANALOR	68
DAIKIN	VRV - HIDROBOX	75
DAIKIN	VRV - NJËSI TË JASHTME	76
DAIKIN	ALTHERMA	90
DAIKIN	DEPOZITË TERMIKE	99
XTRON	MONO SPLIT	104
XTRON	KALDAJA ELEKTRIKE	105
APE	SERIA AP, RAKORDERI ME PRESIM PËR TUBA MULTIST-RAT	107
APE	SERIA APL, RAKORDERI ME PRESIM PËR TUBA MULTIST-RAT	111

APE	RAKORDERI ME SHTRENGIM PER TUBA MULTISTRAT	114
APE	RAKORDERI ME FILETE	120
APE	SERIA E KOLEKTORVE DHE ADAPTORVE	123
APE	TUBA MULTISTRAT	126
APE	RAKORDERI GAZI	127
APE	TUBA GAZI	129
APE	THERM NGROHJE RADIANTE NGA DYSHEMEJA	130
FAR	GRUPET E PRESIONIT DHE PJESËT E KËMBIMIT	133
FAR	KOLEKTOR TË NDRYSHËM	138
FAR	GRUPET E PRESIONIT DHE PJESËT E KËMBIMIT	139
FAR	DADO PER RAKORDE ME KOMPRESIM	141
FAR	VALVULAT E RADIATORIT	142
FAR	RAKORDERI ME PRESË PËR MULTISTRAT	144
CHERBROS	VALVULA SFERIKE, CHERPLUS, DIVA	147
CHERBROS	VALVULA PËR GAZ, DIVA / RUBINETET, CHERPLUS, CHERNORM	148
CHERBROS	VALVULA SFERIKE KËNDORE, CHERPLUS	149
CHERBROS	VALVULA SFERIKE TË VOGLA, CHERPLUS, CHERNORM	150
CHERBROS	VALVULAT REDUKTUESE DHE KONTROLLUESE TË PRESIONIT	151
CHERBROS	VALVULAT E RADIATORIT	152
CHERBROS	KOLEKTORËT	154
CHERBROS	DADO PËR RAKORDE ME KOMPRESIM	155
CHERBROS	KUTI SHPËRNDARESE E INTEGRUAR ME BRRYL	156
CHERBROS	RAKORDE KOMPRIMIMI PËR TUBAT PE-X	157
CHERBROS	RAKORDE KOMPRIMIMI PËR TUBA AL PEX	159
CHERBROS	RAKORDET E KOMPRIMIT PËR SISTEMIN DIELLOR	160
CHERBROS	RAKORDE TË FILETUARA	161
CHERBROS	SALDIM/TEFLON/FISHEKË	167
BONOMI	SARACINESKA	168
BONOMI	SARACINESKA, BUKETONA, TAPA, ÇEZMA, BRRYL	169
BONOMI	DETENTOR KALORIFERI, KOLEKTOR, KONDRVALVOL, FILTER, SARACINESKE	170
SOLIN	TUB PE-X	172
SOLIN	TUB, VESHJE TUBI	173
SOLIN	TUB, BRRYL, RAKORD, URA, SILIKON	174
SOLIN	RAKORD, ÇELES	175
VIDOFLEX	VESHJE TUBI	177
VIDOFLEX	TUBA, BRRYLA BAKRRI	178
WILO	POMPË KALDAJE	180

WILO	POMPË KALDAJE, POMPË VETËQARKULLUESE	181
WILO	PRESË KONTROLLI, POMPË SHTËPIE, POMPË UJI	182
WILO	POMPË UJI	183
WILO	POMPË ZHYTËSE, POMPË WC-JE, POMPË DRANZHI SHATËRVANI	184
WILO	POMPË DRANAZHI SHATËRVANI, ENË ZGJERIMI	185
WILO	ENË ZGJERIMI, AKSESORË	186
ECOFER	PAKETA ELEKTRONIKE	187
ECOFER	MBLEDHËS LAGËSHTIE, KONDICIONER PINGUIN	188
ECOFER	PAKETË ELEKTRIKE	189
ELENTEK	PRESOSTAT, GALIXHAN, BAZAMENT, KOLEKTOR	190
MAGNA-PLAST	TUB PP	192
MAGNA-PLAST	BRRYL PP, YPSILON PP, TAPA PP	193
MAGNA-PLAST	YPSILON PP, REDUKSION PP	194
MAGNA-PLAST	MANIKOTA PP, TI PP, BRRYL PP, REDUKSION PP, MANIKOT PP	195
MAGNA-PLAST	MANIKOTA PP, GOMIN PP, KAPELE PP, FASHETA PP, BRRYL PP, LUBRIFIKANT	196
MAGNA-PLAST	TUBA PP SERIA BLU - ULTRA DB	197
MAGNA-PLAST	YPSILON PP, REDUKSION PP, TAPA PP, MANIKOTA PP, TI PP	198
MAGNA-PLAST	YPSILON PP	199
FASO-PLAST	TUBAT DHE RAKORDERITË PP	200
PESTAN	TUBAT PPR FLUIDTERM	202
PESTAN	RAKORDERITË PPR FLUIDTERM	203
PESTAN	TUBAT S-LINE ME NJË DHE DY GOTA	209
PESTAN	RAKORDERITË S-LINE	212
PESTAN	TUBAT DHE RAKORDERITË HTPP	216
PESTAN	TUBAT DHE RAKORDERITË HTPPR	218
PESTAN	TUBAT HDPE	221
ATUSA	TUBO ÇELIKU, XINGATO, RAKORDERI	222
ATUSA	RAKORDERI XINGATO	223
ATUSA	RAKORDERI TË ZEZA	225
ATUSA	KALORIFER BANJO	227
ATUSA	AKSESORË	228
ATUSA	FASHETA BAKRI	230
ATUSA	DIZHA, KALDAJ ÇELIKU, PRESE	231
ATUSA	GRUPE INOKSI	232
ROCA	SERIA BEYOND	234
ROCA	SERIA INSPIRA WC	236
ROCA	SERIA INSPIRA LAVAMAN	238

ROCA	SERIA MERIDIAN	239
ROCA	SERIA GAP	242
ROCA	SERIA NEXO	245
ROCA	SERIA DEBBA	248
ROCA	SERIA CARMEN	251
ROCA	SERIA ADELE	253
ROCA	SERIA VICTORIA	255
ROCA	ROCA PORCELANE	257
ROCA	ATLAS GRUPET	258
ROCA	ATLAS - CARMEN GRUPET	259
ROCA	AROLA GRUPET	260
ROCA	VICTORIA GRUPET	261
ROCA	LANTA - MONODIN GRUPET	262
ROCA	INSIGNIA - CORAL GRUPET	263
ROCA	NAIA, MALVA, ANARA - GRUPET	264
ROCA	GRUPE DUSHI	265
ROCA	GRUPE DUSHI, SALISHENT	266
ROCA	KOKË DUSHI	268
ROCA	GRUPE LAVAPJATE	271
ROCA	ROCA - PLLAKË DUSHI	272
ROCA	ROCA - VASKA	273
ROCA	ROCA - GABINË DUSHI VICTORIA	274
ROCA	ROCA - MOBILJE	275
ROCA	ROCA - BUTON KASETE	276
ROCA	ROCA - KASETË INKASO	277
ROCA	ROCA - BUTON KASETE	278
ROCA	ROCA - FRESIBËL	280
ROCA	ROCA - AKSESORË	281
DEMM	SERIA LUI	290
DEMM	SERIA LEI	292
DEMM	SERIA ACIARIUM	294
DEMM	SERIA MY TIME	298
DEMM	SERIA TIMELESS	301
DEMM	SERIA SHINE	303
DEMM	SERIA DRAKE	305
DEMM	SERIA SLEEK	307
DEMM	SERIA SILK	310
DEMM	SERIA MINY	312
DEMM	SERIA SPIKE	315

DEMM	SERIA ELIT	317
DEMM	SERIA MOVE	319
DEMM	SERIA KUOVADIS	321
DEMM	SERIA GRANGE	323
DEMM	SERIA MODA	325
DEMM	SERIA IVORY	327
DEMM	SERIA LOE	329
DEMM	SERIA JAGO	331
DEMM	SERIA KITCHEN	333
DEMM	SERIA CONCEALED	336
DEMM	SERIA SHOWER COLUMN	340
HYDRO BS	VASKA	348
HYDRO BS	PASQYRË LED	351
HYDRO BS	PASQYRË LED DHE AKSESORË	353
HYDRO BS	KASETA METALIKE DHE AKSESORË	355
HYDRO BS	ANTIFRIZE, AKSESORË	356
HYDRO BS	CR SMART DHE HYDROSPIRAL	357
HIDROFLEX	FRESIBEL	359
HIDROFLEX	REZISTENCA DUSHI ELEKTRIK DHE PANELI DIELLOR	360
HIDROFLEX	SHKRIPËZUES, GOMINA	361
TEA	KANALINA PLASTIKE	362
TEA	PILET	363
SPEK	AKSESORË	365
DROPS	FILTËR UJI, GOTË, FISHEK	368
DROPS	FISHEK, NIPEL, ÇELËS, STAFE, ZBUTËS UJI	369
DROPS	ZBUTËS UJI	370
THERMIKI	SOBA DRURI, OXHAK	371
ROTHENBERGER	VEGLA PUNE	375
MOBIAK	KASETA HIDRANTI	381

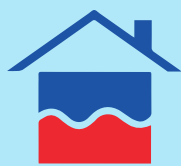

HIDROSYSTEM[®]
SISTEME NGROHJE & FTOHJE

HIDROTHERM[®]
ΗΛΙΑΚΑ ΣΥΣΤΗΜΑΤΑ

QËNDRUESHMËRIA MË E MIRË E BOLIERAVE

Ofron cilësi dhe pastërti uji të garantuar





Panelet Diellore Hidrotherm

Panel Diellor Hidrotherm INOX 3



Kodi	Përmasat	Cmimi
65558	120 Litra	-

Panel Diellor Hidrotherm INOX 2



Kodi	Përmasat	Cmimi
47865	120 Litra	-

Panel Diellor Hidrotherm INOX 1



Kodi	Përmasat	Cmimi
66499	120 Litra	-

Panel Diellor Hidrotherm INOX magnetic 3



Kodi	Përmasat	Cmimi
28423	120 Litra	-

Panel Diellor Hidrotherm INOX magnetic 2



Kodi	Përmasat	Cmimi
57537	120 Litra	-

Panel Diellor Hidrotherm INOX magnetic



Kodi	Përmasat	Cmimi
98527	120 Litra	-

Panel Diellor Hidrotherm INOX magnetic 3



Kodi	Përmasat	Cmimi
28423	120 Litra	-

Panel Diellor Hidrotherm Metalixato 2



Kodi	Përmasat	Cmimi
66349	120 Litra	-

Panel Diellor Hidrotherm Metalixato 1

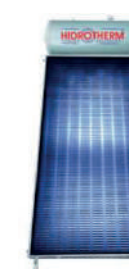

Kodi	Përmasat	Cmimi
48315	120 Litra	-

Panele Diellore

Ngrohje & Ftohje

Hidraulike

Hidrosanitare

Aksesore të ndryshëm

Panel Diellor Hidrotherm INOX 3



Kodi	Përmasat	Cmimi
38233	150 Litra	-

Panel Diellor Hidrotherm INOX 2



Kodi	Përmasat	Cmimi
15928	150 Litra	-

Panel Diellor Hidrotherm INOX 1



Kodi	Përmasat	Cmimi
19637	150 Litra	-

Panel Diellor Hidrotherm INOX Metalixato 3 Panel Diellor Hidrotherm INOX magnetic 2 Panel Diellor Hidrotherm INOX magnetic 1



Kodi	Përmasat	Cmimi
83647	150 Litra	-



Kodi	Përmasat	Cmimi
16879	150 Litra	-



Kodi	Përmasat	Cmimi
21379	150 Litra	-

Panel Diellor Hidrotherm Metalixato 3



Kodi	Përmasat	Cmimi
71415	150 Litra	-

Panel Diellor Hidrotherm Metalixato 2



Kodi	Përmasat	Cmimi
46479	150 Litra	-

Panel Diellor Hidrotherm Metalixato 1



Kodi	Përmasat	Cmimi
85246	150 Litra	-



Panelet Diellore Hidrotherm

Panel Diellor Hidrotherm INOX 3



Kodi	Përmasat	Cmimi
69624	200 Litra	-

Panel Diellor Hidrotherm INOX 2

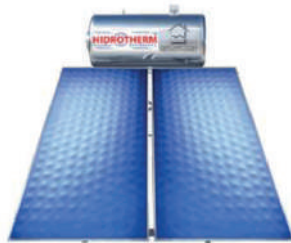

Kodi	Përmasat	Cmimi
28686	200 Litra	-

Panel Diellor Hidrotherm INOX 1



Kodi	Përmasat	Cmimi
75367	200 Litra	-

Panel Diellor Hidrotherm INOX Metalixato 3

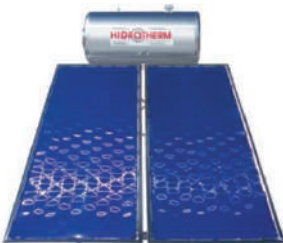

Kodi	Përmasat	Cmimi
82397	200 Litra	-

Panel Diellor Hidrotherm INOX magnetic 2



Kodi	Përmasat	Cmimi
67254	200 Litra	-

Panel Diellor Hidrotherm INOX magnetic 1



Kodi	Përmasat	Cmimi
28618	200 Litra	-

Panel Diellor Hidrotherm Metalixato 3

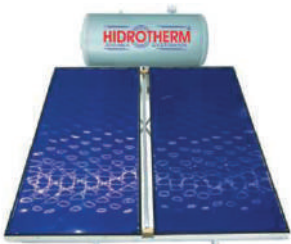

Kodi	Përmasat	Cmimi
47642	200 Litra	-

Panel Diellor Hidrotherm Metalixato 2

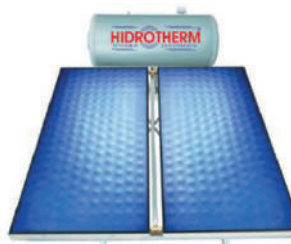

Kodi	Përmasat	Cmimi
19477	200 Litra	-

Panel Diellor Hidrotherm Metalixato 1



Kodi	Përmasat	Cmimi
52864	200 Litra	-

Panelet Diellore

Ngrohje & Ftohje

Hidraulike

Hidrosanitare

Aksesore të ndryshëm

Panel Diellor Hidrotherm INOX 3

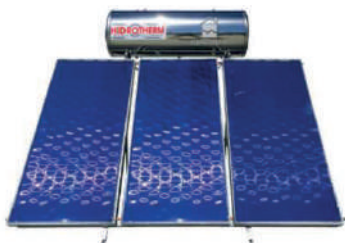

Kodi	Përmasat	Cmimi
41269	300 Litra	-

Panel Diellor Hidrotherm INOX 2



Kodi	Përmasat	Cmimi
18551	300 Litra	-

Panel Diellor Hidrotherm INOX 1



Kodi	Përmasat	Cmimi
27769	300 Litra	-

Panel Diellor Hidrotherm INOX magnetic 3

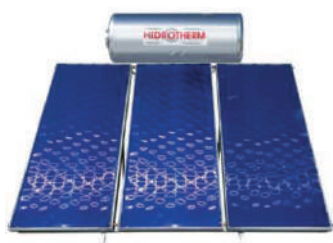

Kodi	Përmasat	Cmimi
74328	300 Litra	-

Panel Diellor Hidrotherm INOX magnetic 2



Kodi	Përmasat	Cmimi
19544	300 Litra	-

Panel Diellor Hidrotherm INOX magnetic 1



Kodi	Përmasat	Cmimi
48775	300 Litra	-

Panel Diellor Hidrotherm Metalixato 3

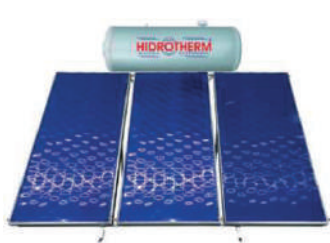

Kodi	Përmasat	Cmimi
49597	300 Litra	-

Panel Diellor Hidrotherm Metalixato 2

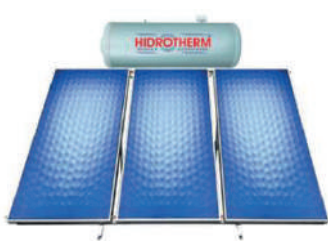

Kodi	Përmasat	Cmimi
26738	300 Litra	-

Panel Diellor Hidrotherm Metalixato 1



Kodi	Përmasat	Cmimi
63843	300 Litra	-



Bolierët

Bolier Inox Hidrotherm 120L



Kodi	Përmasat	Cmimi
13644	120 Litra	-

Bolier Inox Hidrotherm 150L



Kodi	Përmasat	Cmimi
72866	150 Litra	-

Bolier Inox Hidrotherm 200L



Kodi	Përmasat	Cmimi
91413	200 Litra	-

Bolier Inox Hidrotherm 300L



Kodi	Përmasat	Cmimi
98248	300 Litra	-

Bolier Inox Magnetik Hidrotherm 120L



Kodi	Përmasat	Cmimi
94874	120 Litra	-

Bolier Inox Magnetik Hidrotherm 150L



Kodi	Përmasat	Cmimi
81829	150 Litra	-

Bolier Inox Magnetik Hidrotherm 200L



Kodi	Përmasat	Cmimi
44342	200 Litra	-

Bolier Inox Magnetik Hidrotherm 300L



Kodi	Përmasat	Cmimi
24538	300 Litra	-

Bolier Metalizato Hidrotherm 120L



Kodi	Përmasat	Cmimi
48184	120 Litra	-

Bolier Metalizato Hidrotherm 150L



Kodi	Përmasat	Cmimi
93673	150 Litra	-

Bolier Metalizato Hidrotherm 200L



Kodi	Përmasat	Cmimi
26848	200 Litra	-

Bolier Metalizato Hidrotherm 300L



Kodi	Përmasat	Cmimi
84267	300 Litra	-

Panele Diellore

Ngrohje & Ftohje

Hidraulike

Hidrosanitare

Aksesorë të ndryshëm



Pasqyrat e Paneleve Diellore

Pasqyrë Paneli Diellor – Modeli Navi+Evo 15



Kodi	Përmasat	Cmimi
62946	1531 x 1011 x 95	-

Pasqyrë Paneli Diellor – Modeli Navi+Evo 20



Kodi	Përmasat	Cmimi
62946	2031 x 1011 x 95	-

Pasqyrë Paneli Diellor – Modeli Navi+Evo 25



Kodi	Përmasat	Cmimi
62946	2031 x 1241 x 95	-

Pasqyrë Paneli Diellor – Modeli Full 20



Kodi	Përmasat	Cmimi
82464	2006 x 1007 x 85	-

Pasqyrë Paneli Diellor – Modeli Full 25



Kodi	Përmasat	Cmimi
82464	2006 x 1257 x 85	-

Pasqyrë Paneli Diellor – Modeli Full 29

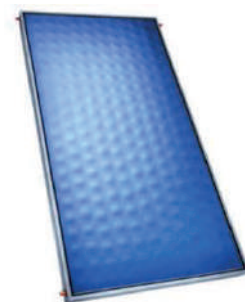

Kodi	Përmasat	Cmimi
82464	2006 x 1457 x 85	-

Pasqyrë Paneli Diellor – Modeli Strip 20

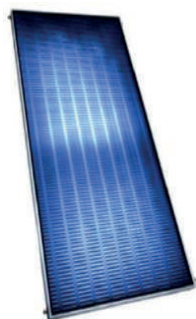

Kodi	Përmasat	Cmimi
94429	2006 x 1007 x 85	-

Pasqyrë Paneli Diellor – Modeli Strip 25

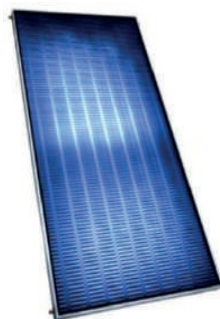

Kodi	Përmasat	Cmimi
94429	2006 x 1257 x 85	-

Pasqyrë Paneli Diellor – Modeli Strip 29

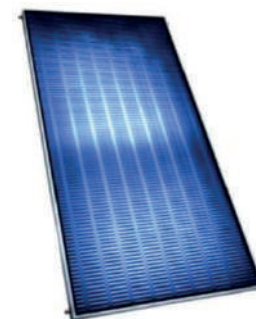

Kodi	Përmasat	Cmimi
94429	2006 x 1457 x 85	-

Kambalec tarace Neo+ Flat



Kodi	Modeli	Cmimi
108336	120 litra	-

Kambalec tarace Neo+ Flat



Kodi	Modeli	Cmimi
108336	150 litra	-

Kambalec tarace Neo+ Flat



Kodi	Modeli	Cmimi
109488	200 litra	-

Kambalec catie Neo+ TSS



Kodi	Modeli	Cmimi
109379	120 litra	-

Kambalec catie Neo+ TSS



Kodi	Modeli	Cmimi
109379	150 litra	-

Kambalec catie Neo+ TSS



Kodi	Modeli	Cmimi
109729	200 litra	-

Kambalec tarace Neo+ Eco



Kodi	Modeli	Cmimi
109728	120 litra	-

Kambalec tarace Neo+ Eco



Kodi	Modeli	Cmimi
109728	150 litra	-

Kambalec tarace Neo+ Eco



Kodi	Modeli	Cmimi
109729	200-300 litra	-

Panele Diellore

Ngrohje & Ftohje

Hidraulike

Hidrosanitare

Aksesorë të ndryshëm

Kambalec pasqyrash Neo+ Col



Kodi	Modeli	Cmimi
108476	1 pasqyre 2x1	-

Kambalec pasqyrash Neo+ Col



Kodi	Modeli	Cmimi
108476	1pasqyre 2x1.45	-

Kambalec pasqyrash Neo+ Col



Kodi	Modeli	Cmimi
108477	2 pasqyre 2x1	-

Aksesore per panel dielllore
120L,150L,200L,300L



Kodi	Modeli	Cmimi
-	Aksesor paneli 120L,150L,200L,300L	-

Bolier Uji , BLS-0

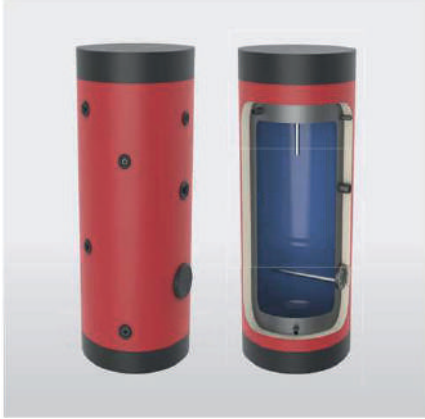

Bolier Uji , BLS-0



Bolier Uji , BLS-1

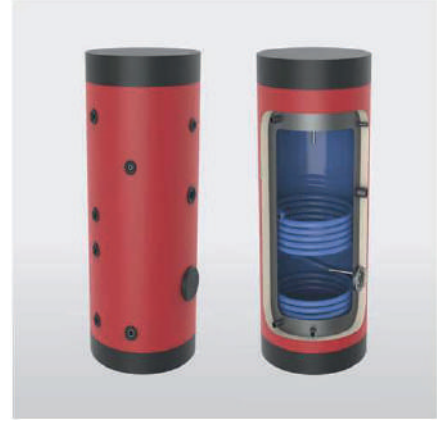

Kodi	Përmasat	Cmimi
BLS0-C 150	150L	-
BLS0-C 200	200L	-
BLS0-C 300	300L	-
BLS0-C 500	500L	-

Kodi	Përmasat	Cmimi
BLS0-C 750	750L	-
BLS0-C 1000	1000L	-

Kodi	Përmasat	Cmimi
BLS1-C 150	150L	-
BLS1-C 200	200L	-
BLS1-C 300	300L	-
BLS1-C 500	500L	-

Bolier Uji , BLS-1



Bolier Uji , BLS-2



Bolier Uji , BLS-2



Kodi	Përmasat	Cmimi
BLS1-C 750	750L	-
BLS1-C 1000	1000L	-

Kodi	Përmasat	Cmimi
BLS2-C 150	150L	-
BLS2-C 200	200L	-
BLS2-C 300	300L	-
BLS2-C 500	500L	-

Kodi	Përmasat	Cmimi
BLS2-C 750	750L	-
BLS2-C 1000	1000L	-

Panele Diellore

Ngrohje & Ftohje

Hidraulike

Hidrosanitare

Aksesorë të ndryshëm

Bolier Uji , BLS-2

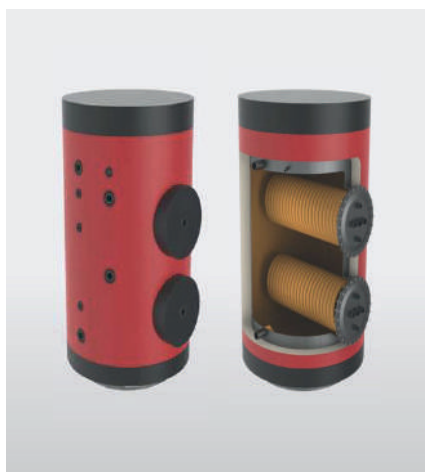

Bolier Uji , BLS-2



Bolier Uji , BLS-2



Kodi	Përmasat	Cmimi
BLS2 - 500	500L	-
BLS2 - 750	750L	-
BLS2 - 1000	1000L	-
BLS2 - 1500	1500L	-

Kodi	Përmasat	Cmimi
BLS2 - 2000	2000L	-
BLS2 - 2500	2500L	-
BLS2 - 3000	3000L	-
BLS2 - 4000	4000L	-

Kodi	Përmasat	Cmimi
BLS2 - 5000	5000L	-
BLS2 - 7000	7000L	-
BLS2 - 9000	9000L	-

HIDROTHERM

PLAFON SISTEMATA



10 L



50 L



80 L



100 L



120 L



ENERG Y UJA
енергия · ενέργεια IE IA

HIDROTHERM AD 80L

M

A+
A
B
C
D
E
F

C

15 dB

1411 kWh/annum

Kapaciteti 30-150 l
Mbrojtje elektrostatike e smaltit te titanit
Mg Anode-mbrojtje shtese
Predhe celiku e lyer me EP
Izolim PU pa CFC
Instalim vertikal ose horizontal
Treguesi I temperatures

		AD-30 v/h	AD-40 v/h	AD-50 v/h	AD-60 v/h	AD-80 v/h	AD-100 v/h	AD-120 v/h	AD-150 v/h
Vellimi	L	30	40	50	60	80	100	120	150
Tensioni elektrik	V	230	230	230	230	230	230	230	230
Fuqi elektrike	W	1500	1500	1500	2000	2000	2000	2000	2000
Energji elektrike	A	6.5	6.5	6.5	8.7	8.7	8.7	8.7	8.7
Presioni maksimal I punes	MPA	0.6	0.6	0.6	0.6	0.6	0.6	0.6	0.6
Pesha / depozita	KG	15 / 45	16,5 / 56,5	16,5 / 56,5	21/81	24/104	30/130	33/153	37/187
Koha per ngrohje 10-65 °C/min		72	84	96	115	153	192	251	313



BOLIER ELEKTRIK

Lloi	A	B	E	F	G	H	I	K	L	Paketim / mm
AD-40 h	420	∅ 440	469	230	100	172	100	160	260	480 / 460 / 490
AD-50 h	490	∅ 440	540	230	171	172	100	195	260	480 / 460 / 555
AD-60 h	565	∅ 440	615	230	246	172	100	232	260	480 / 460 / 625
AD-80 h	740	∅ 440	790	230	417	172	100	320	260	480 / 460 / 810
AD-100 h	895	∅ 440	945	230	576	172	100	398	260	480 / 460 / 955
AD-120 h	1060	∅ 440	1110	230	741	172	100	480	260	480 / 460 / 1120
AD-150 h	1240	∅ 440	1290	230	920	172	100	570	260	480 / 460 / 1300

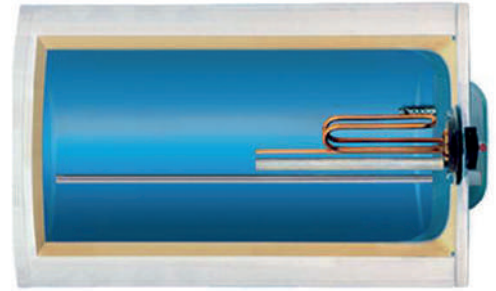

Panele Diellore

Ngrohje & Ftohje

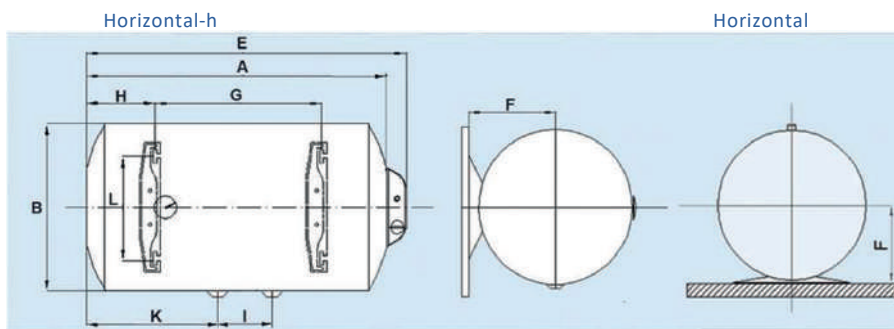

Hidraulike

Hidrosanitare

Aksesore të ndryshëm

Vertikal-v

Vertikal

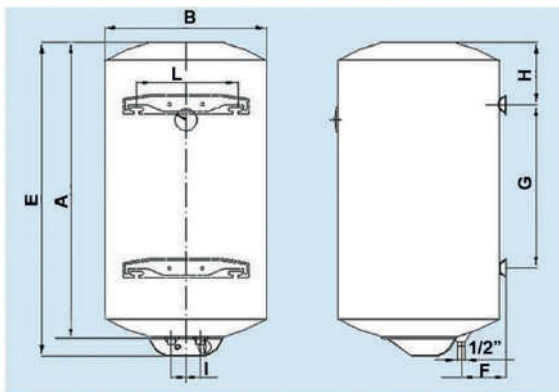

Kapaciteti 30-150 l

Mbrojtje elektrostatike e smaltit të titanit

Mg Anode-mbrojtje shtese

Predhe celiku e lyster me EP

Izolim PU pa CFC

Instalim vertikal ose horizontal

Treguesi I temperatures

Lloi	A	B	E	F	G	H	I	L	Paketim / mm
AD-30 v	338	∅ 440	388	110	-	172	100	260	480 / 460 / 410
AD-40 v	419	∅ 440	469	110	-	172	100	260	480 / 460 / 490
AD-50 v	490	∅ 440	540	110	-	172	100	260	480 / 460 / 555
AD-60 v	565	∅ 440	615	110	-	172	100	260	480 / 460 / 625
AD-80 v	740	∅ 440	790	110	-	172	100	260	480 / 460 / 810
AD-100 v	895	∅ 440	945	110	576	172	100	260	480 / 460 / 955
AD-120 v	1060	∅ 440	1110	110	741	172	100	260	480 / 460 / 1120
AD-150 v	1240	∅ 440	1290	110	920	172	100	260	480 / 460 / 1300



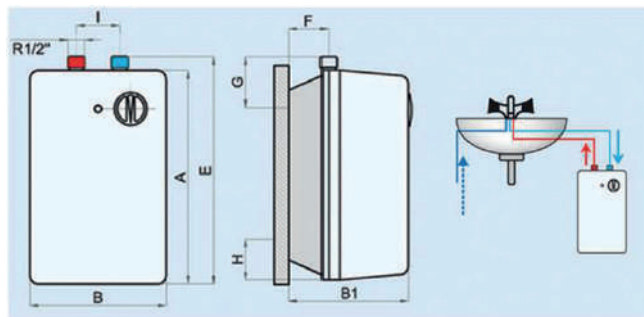

AD-10 un/ub		
Vellimi	L	10
Tensioni elektrik	V	230
Fuqi elektrike	W	1500
Energji elektrike	A	6.8
Presioni maksimal I punes	MPA	0
Pesha / depozita	KG	6.5 / 16.5

Lloi	A	B	B1	E	F	G	H	I	L	Paketim / mm
AD-10 un	410	290	295	435	45	105	85	80	180	450 / 270 / 310
AD-10 ub	410	290	295	435	45	105	85	80	180	450 / 270 / 310

Horizontal



Vertikal





DUSH ELEKTRIK 10-20 L



- Kapaciteti 10 – 20 L
- Mbrojtje e brendshme e bolierit me nje shtrese te vecante lustrimi DURO GLASS
- Mbrojtje katodike e bolierit me nje shtrese shume te madhe magnezi ELCO
- Termostat I sigurte me sugurite vecante termostatike te integruar
- Valvul sigurie me membrane dhe kullim
- Fllanxhe e madhe inspektimi per mirmbajtje me te lehte te ngrohjesit te ujit
- Izolim ekologjik poliuretani I perforcuar
- Instalim Horizontal

Pershkrim		Dush Elektrik	
Vellimi	L	10	20
Fuqi elektrike	kw	1.5	1.5
Energji elektrike	A	6.5	6.5
Tensioni (50/60 Hz)	V	220-240	220-240
Termostati	Game e kontrollit nga 30-80°C, mbrojtje me siguresse termostatike		
Izolimi	Poliuretani I ngurte I zgjeruar pa HCFC te pakten 25 mm e trashe		
Pesha / depozita	KG	7	11
Koha e ngrohjes 45°C	Ore/min	0:24	0:48

L	A	B	C	D	E	G	H	TH	Gjatesia	Gjeresia	Lartesia
10	168	100	95	156	415	445	-	260	440	290	290
20	160	100	134	220	528	553	-	307	325	346	500

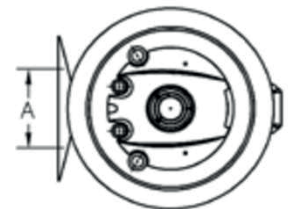
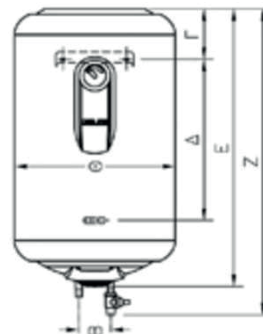
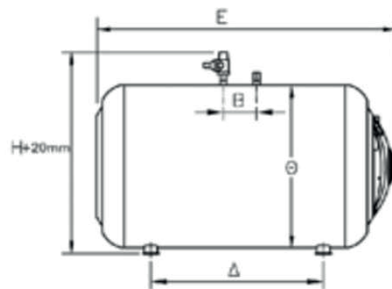
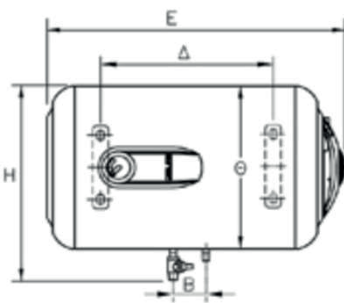

Panele Diellore

Ngrohje & Ftohje

Hidraulike

Hidrosanitare

Aksesore të ndryshëm



- Kapaciteti 45-120 L
- Bolier celiku e specifikimeve speciale e testuar ne 16bar
- Mbrojtje e brendshme e bolierit me nje shtrese te vecante lustrimi DURO GLASS
- Mbrojtje katodike e bolierit me nje shtrese shume te madhe magnezi ELCO
- Rezistence 3.0kw ose 3.7 kw me ngarkese te ulet 316L
- Termostat I sigurte me sugurite vecante termostatike te integruar
- Valvul sigurie me membrane dhe kullim
- Fllanxhe e madhe inspektimi per mirmbajtje me te lehte te ngrohesit te ujit
- Izolim ekologjik poliuretani I perforcuar
- Instalim Vertikal

Pershkrim		Dush Elektrik				
Vellimi	L	45	60	80	100	120
Fuqi elektrike	kw	3.0	3.0 / 3.7	3.0 / 3.7	3.7	3.7
Energji elektrike	A	13.0	13.0 / 16.0	13.0 / 16.0	16.0	16.0
Tensioni (50/60 Hz)	V	220-240	220-240	220-240	220-240	220-240
Termostati	Game e kontrollit nga 30-80°C, mbrojtje me siguresse termostatike					
Izolim	Poliuretani I ngurte I zgjeruar pa HCFC te pakten 25 mm e trashe					
Pesha / depozita	KG	20	22	26	30	36
Koha e ngrohjes 45°C	Ore/min	0:50	1:13 / 0:55	1:37 / 1:13	1:30	1:50

L	A	B	C	D	E	G	H	TH	Gjatesia	Gjeresia	Lartesia
45	280	100	195	169	594	611	495	450	675	500	500
60	280	100	226	186	650	677	495	450	731	500	500
80	280	100	226	336	800	817	495	450	881	500	500
100	280	100	226	486	950	967	495	450	1031	500	500
120	280	100	226	665	1130	1147	495	450	1211	500	500

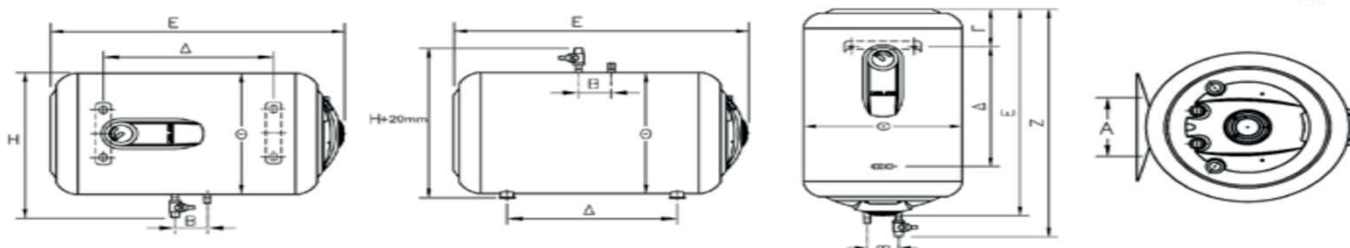



- Kapaciteti 45-120 L
- Bolier celiku e specifikimeve speciale e testuar ne 16bar
- Mbrojtje e brendshme e bolierit me nje shtrese te vecante lustrimi DURO GLASS
- Mbrojtje katodike e bolierit me nje shtrese shume te madhe magnezi ELCO
- Rezistence 3.0kw ose 3.7 kw me ngarkese te ulet 316L
- Termostat I sigurte me sugurite vecante termostatike te integruar
- Valvul sigurie me membrane dhe kullim
- Fillanxe e madhe inspektimi per mirmbajtje me te lehte te ngrohesit te ujit
- Izolim ekologjik poliuretani I perforcuar
- Instalim Horizontal

Perskrim		Dush Elektrik				
Vellimi	L	45	60	80	100	120
Fuqi elektrike	kw	3.0	3.0 / 3.7	3.0 / 3.7	3.7	3.7
Energji elektrike	A	13.0	13.0 / 16.0	13.0 / 16.0	16.0	16.0
Tensioni (50/60 Hz)	V	220-240	220-240	220-240	220-240	220-240
Termostati	Game e kontrollit nga 30-80°C, mbrojtje me siguresse termostatike					
Izolim	Poliuretani I ngurte I zgjeruar pa HCFC te pakten 25 mm e trashe					
Pesha / depozita	KG	20	22	26	30	36
Koha e ngrohjes 45°C	Ore/min	0:50	1:13 / 0:55	1:37 / 1:13	1:30	1:50

L	A	B	C	D	E	G	H	TH	Gjatesia	Gjeresia	Lartesia
45	280	100	195	169	594	611	495	450	675	500	500
60	280	100	226	186	650	677	495	450	731	500	500
80	280	100	226	336	800	817	495	450	881	500	500
100	280	100	226	486	950	967	495	450	1031	500	500
120	280	100	226	665	1130	1147	495	450	1211	500	500

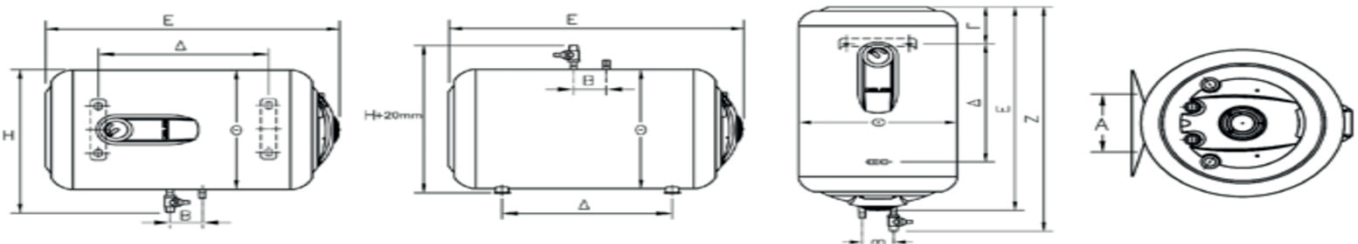



- Kapaciteti 45-120 L
- Bolier celiku e specifikimeve speciale e testuar ne 16bar
- Mbrojtje e brendshme e bolierit me nje shtrese te vecante lustrimi TITAN
- Mbrojtje katodike e bolierit me nje shtrese shume te madhe magnezi ELCO
- Rezistence 3.0kw ose 3.7 kw me ngarkese te ulet 316L
- Termostat I sigurte me sugurite vecante termostatike te integruar
- Valvul sigurie me membrane dhe kullim
- Fllanxhe e madhe inspektimi per mirmbajtje me te lehte te ngrohesit te ujit
- Izolim ekologjik poliuretani I perforcuar
- Instalim Vertical

Pershkrim		Dush Elektrik				
Vellimi	L	45	60	80	100	120
Fuqi elektrike	kw	3.0	3.0 / 3.7	3.0 / 3.7	3.7	3.7
Energji elektrike	A	13.0	13.0 / 16.0	13.0 / 16.0	16.0	16.0
Tensioni (50/60 Hz)	V	220-240	220-240	220-240	220-240	220-240
Termostati	Game e kontrollit nga 30-80°C, mbrojtje me siguresse termostatike					
Izolim	Poliuretani I ngurte I zgjeruar pa HCFC te pakten 25 mm e trashe					
Pesha / depozita	KG	20	22	26	30	36
Koha e ngrohjes 45°C	Ore/min	0:50	1:13 / 0:55	1:37 / 1:13	1:30	1:50

L	A	B	C	D	E	G	H	TH	Gjatesia	Gjeresia	Lartesia
45	280	100	195	169	594	611	495	450	675	500	500
60	280	100	226	186	650	677	495	450	731	500	500
80	280	100	226	336	800	817	495	450	881	500	500
100	280	100	226	486	950	967	495	450	1031	500	500
120	280	100	226	665	1130	1147	495	450	1211	500	500

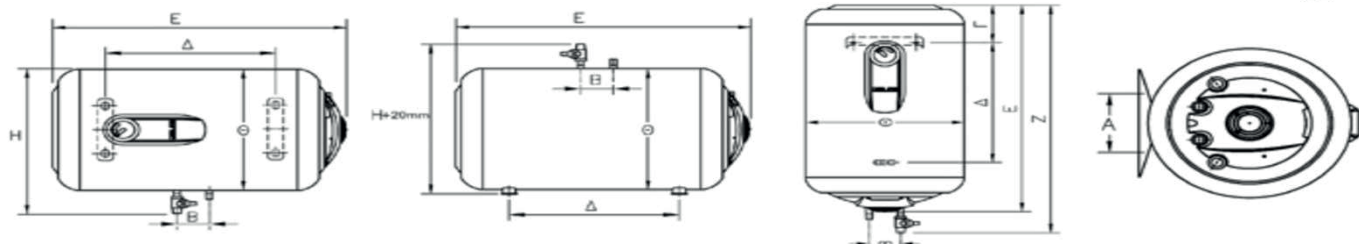



- Kapaciteti 45-120 L
- Bolier celiku e specifikimeve speciale e testuar ne 16bar
- Mbrojtje e brendshme e bolierit me nje shtrese te vecante lustrimi TITAN
- Mbrojtje katodike e bolierit me nje shtrese shume te madhe magnezi ELCO
- Rezistence 3.0kw ose 3.7 kw me ngarkese te ulet 316L
- Termostat I sigurte me sugurite vecante termostatike te integruar
- Valvul sigurie me membrane dhe kullim
- Fillanxe e madhe inspektimi per mirmbajtje me te lehte te ngrohesit te ujit
- Izolim ekologjik poliuretani I perforcuar
- Instalim Horizontal

Perskrim		Dush Elektrik				
Vellimi	L	45	60	80	100	120
Fuqi elektrike	kw	3.0	3.0 / 3.7	3.0 / 3.7	3.7	3.7
Energji elektrike	A	13.0	13.0 / 16.0	13.0 / 16.0	16.0	16.0
Tensioni (50/60 Hz)	V	220-240	220-240	220-240	220-240	220-240
Termostati	Game e kontrollit nga 30-80°C, mbrojtje me siguresse termostatike					
Izolim	Poliuretani I ngurte I zgjeruar pa HCFC te pakten 25 mm e trashe					
Pesha / depozita	KG	20	22	26	30	36
Koha e ngrohjes 45°C	Ore/min	0:50	1:13 / 0:55	1:37 / 1:13	1:30	1:50

L	A	B	C	D	E	G	H	TH	Gjatesia	Gjeresia	Lartesia
45	280	100	195	169	594	611	495	450	675	500	500
60	280	100	226	186	650	677	495	450	731	500	500
80	280	100	226	336	800	817	495	450	881	500	500
100	280	100	226	486	950	967	495	450	1031	500	500
120	280	100	226	665	1130	1147	495	450	1211	500	500

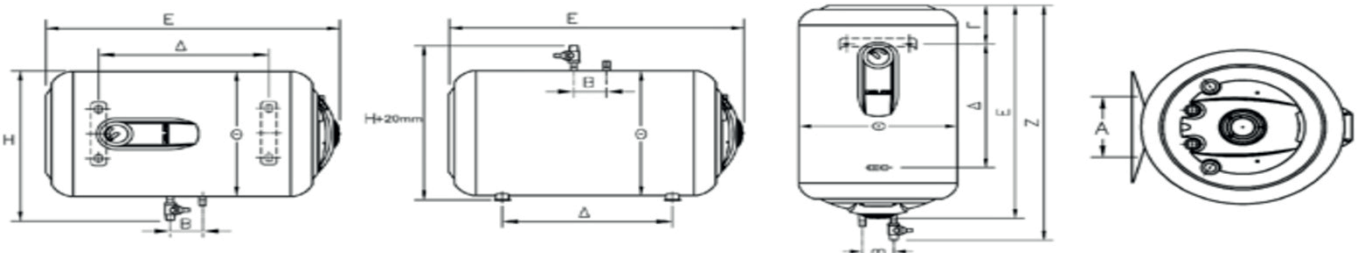
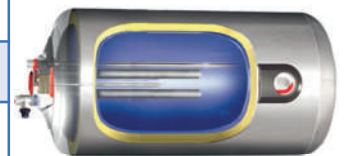



- Kapaciteti 45-120 L
- Bolier celiku e specifikimeve speciale e testuar ne 16bar
- Mbrojtje e brendshme e bolierit me nje shtrese te vecante lustrimi FLOOR GLASS
- Mbrojtje katodike e bolierit me nje shtrese shume te madhe magnezi ELCO
- Rezistence 3.0kw ose 3.7 kw me ngarkese te ulet 316L
- Termostat I sigurte me sugurite vecante termostatike te integruar
- Valvul sigurie me membrane dhe kullim
- Fillanxe e madhe inspektimi per mirmbajtje me te lehte te ngrohesis te ujit
- Izolim ekologjik poliuretani I perforcuar
- Instalim Vertikal

Perskrim		Dush Elektrik				
Vellimi	L	45	60	80	100	120
Fuqi elektrike	kw	3.0	3.0 / 3.7	3.0 / 3.7	3.7	3.7
Energji elektrike	A	13.0	13.0 / 16.0	13.0 / 16.0	16.0	16.0
Tensioni (50/60 Hz)	V	220-240	220-240	220-240	220-240	220-240
Termostati	Game e kontrollit nga 30-80°C, mbrojtje me siguresse termostatike					
Izolim	Poliuretani I ngurte I zgjeruar pa HCFC te pakten 25 mm e trashe					
Pesha / depozita	KG	20	22	26	30	36
Koha e ngrohjes 45°C	Ore/min	0:50	1:13 / 0:55	1:37 / 1:13	1:30	1:50

L	A	B	C	D	E	G	H	TH	Gjatesia	Gjeresia	Lartesia
45	280	100	195	169	594	611	495	450	675	500	500
60	280	100	226	186	650	677	495	450	731	500	500
80	280	100	226	336	800	817	495	450	881	500	500
100	280	100	226	486	950	967	495	450	1031	500	500
120	280	100	226	665	1130	1147	495	450	1211	500	500

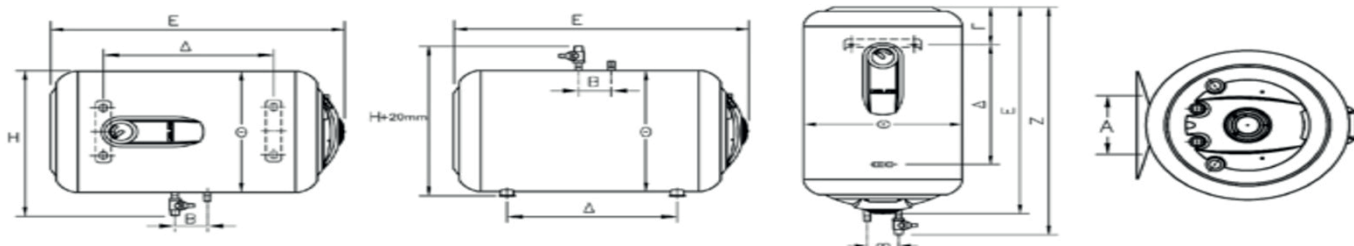



- Kapaciteti 60-120 L
- Ngrohësit e ujit me energji të dyfishtë ELCO TITAN dhe ELCO DURO GLASS kanë një shkëmbyes nxehtësie prej çeliku të emaluar me sipërfaqe të madhe në formën e një spirale (spiralje). Kjo siguron performancë më të mirë të pajisjes dhe mbrojtje nga korrozioni, duke ofruar ujë të nxehtë "falas" në dimër dhe verë, pasi lidhet me radiatorin dhe panelet diellore.
- Instalim Horizontal - Vertikal

Pershkrim		Bolier Elektrik			
Vellimi	L	60	80	100	120
Fuqi elektrike	kw	3.7	3.7	3.7	3.7
Energji elektrike	A	16.0	16.0	16.0	16.0
Tensioni (50/60 Hz)	V	220-240	220-240	220-240	220-240
Termostati	Game e kontrollit nga 30-80°C, mbrojtje me siguresse termostatike				
Izolim	Poliuretani I ngurte I zgjeruar pa HCFC te pakten 25 mm e trashe				
Pesha / depozita	KG	25.5	31	35	41
Koha e ngrohjes 45°C	Ore/min	Ne 20 min keni uje te ngrohje	Ne 20 min keni uje te ngrohje	Ne 20 min keni uje te ngrohje	Ne 20 min keni uje te ngrohje

L	A	B	C	D	E	G	H	TH	Gjatesia	Gjeresia	Lartesia
45	280	100	195	169	594	611	495	450	675	500	500
60	280	100	226	186	650	677	495	450	731	500	500
80	280	100	226	336	800	817	495	450	881	500	500
100	280	100	226	486	950	967	495	450	1031	500	500
120	280	100	226	665	1130	1147	495	450	1211	500	500

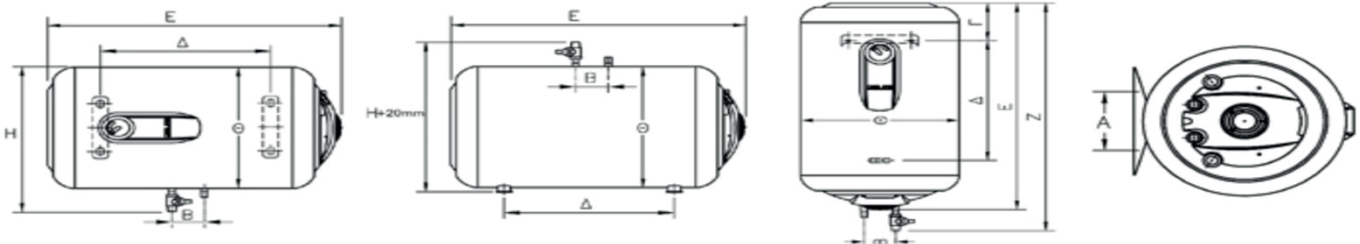
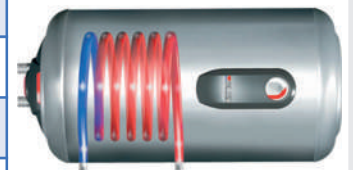

Elco - Termostat



Elco - Termostat



Elco – Kapak



Kodi	Përshkrimi	Cmimi
108002	Terrmostat dushi elektrik (DG)-ELCO	-

Kodi	Përshkrimi	Cmimi
108027	Terrmostat dushi elektrik (OEM)-ELCO	-

Kodi	Përshkrimi	Cmimi
110045/1 11031	Kapak plastic+llambe per dushe-ELCO	-

Sonde per pakete elektronike e zeze



Kodi	Modeli	Cmimi
59251	e zeze	-





Mono-Split Daikin Ururu Sarara FTXZ-RXZ

Daikin zgjidhje kondicionimi për shtëpinë tuaj

Ururu Sarara FTXZ

Kondicioner me montim në mur



Karakteristikat dhe funksionet

Efikasiteti	Funksionet	Pastrimi i ajrit
Rrjedha e ajrit	Kontroll i lagështires	Kontroll dhe planifikim

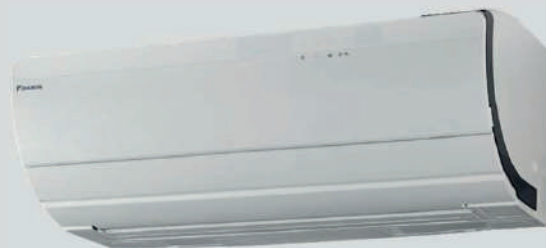

FTXZ-N



RXZ-N



ARC477A1



BRP069B4Z

Të dhënat e efikasitetit	FTXZ + RXZ		25N + 25N	35N + 35N	50N + 50N	
Kapaciteti ftohës	Min./Nom./Max.	kW	0,6/2,5/3,9	0,6/3,5/5,3	0,6/5,0/5,8	
Kapaciteti i ngrohjes	Min./Nom./Max.	kW	0,6/3,6/7,5	0,6/5,0/9,0	0,6/6,3/9,4	
Fuqia hyrëse	Ftohja	Min./Nom./Max.	kW	0,11/0,41/0,88	0,11/0,66/1,33	0,11/1,10/1,60
	Ngrohje	Min./Nom./Max.	kW	0,10/0,62/2,01	0,10/1,00/2,53	0,10/1,41/2,64
Ftohja e hapësirës	Klasi e efikasitetit të energjisë			A+++		
	Kapaciteti	Pdesign	kW	2,50	3,50	5,00
	SHIKUES			9,54	9,00	8,60
	Konsumi vjetor i energjisë		kWh/a	92	136	203
Ngrohja e hapësirës (klima mesatare)	Klasi e efikasitetit të energjisë			A+++		
	Kapaciteti	Pdesign	kW	3,50	4,50	5,60
	SCOP/A			5,90	5,73	5,50
	Konsumi vjetor i energjisë		kWh/a	831	1.100	1.427

Njësia e brendshme	FTXZ		25N	35N	50N	
Dimensione	Njësia	Lartësi x Gjerësi x Thellësia	mm	295x798x372		
Filter ajri	Lloji			Filtër i pastrimit automatik		
Niveli i presionit të zërit	Ftohja	Funksionim i heshtur / l ulët / Num. / l lartë	dB(A)	19/26/33/38	19/27/35/42	23/30/38/47
	Ngrohje	Funksionim i heshtur / l ulët / Num. / l lartë	dB(A)	19/28/35/39	19/29/36/42	24/31/38/44

Njësi e jashtme	RXZ		25N	35N	50N	
Dimensione	Njësia	Lartësi x Gjerësi x Thellësia	mm	693x795x300		
Niveli i presionit të zërit	Ftohja	Lartë	dB(A)	46	48	49
	Ngrohje	Lartë	dB(A)	46	48	50
Gama e funksionimit	Ftohja	Ambienti Min.~Maks.	°CDB	-10~43		
	Ngrohje	Ambienti Min.~Maks.	°CDB	-20~18		
Ftohës	Lloji / GWP / Ngarkesa		kg / TCO ₂ Eq	R-32/675/1,34/0,9		
Lidhjet e tubacioneve	Gjatësia tubacionit	OU - IU	Maks.	m		
	Diametri	IU - OU	Maks.	m		
Furnizimi me energji elektrike	Faza / Amp. maksimal të siguresave (MFA)		A	1~/16		



Mono-Split Daikin Sensira FTXF-RXF









Daikin zgjidhje kondicionimi për shtëpinë tuaj

Sensira FTXF

Kondicioner me montim në mur



Karakteristikat dhe funksionet

Efikasiteti	Funksionet	Pastrimi i ajrit	Kontroll dhe planifikim	Funksione të tjera
	  		  optionale	 Modbus KAX DIII- Net



Të dhënat e efikasitetit		FTXF + RXF	20E + 20E	25E + 25E	35E + 35E	42E + 42E	50D + 50D	60D + 60D	71D + 71D	
Kapaciteti ftohës	Min./Nom./Max.	kW	1,3/2,0/2,4	1,3/2,5/2,8	1,3/3,3/3,8	1,4/4,2/4,3	1,7/5,0/6,0	1,7/6,0/7,0	2,3/7,1/7,3	
Kapaciteti i ngrohjes	Min./Nom./Max.	kW	1,3/2,4/3,3	1,3/2,8/3,7	1,3/3,5/4,4	1,4/4,6/5,0	1,7/6,0/7,7	1,7/6,4/8,0	2,3/8,2/9,0	
Fuqia hyrëse	Ftohja	Min./Nom./Max.	kW	0,31/0,59/0,72	0,31/0,77/1,05	0,31/1,00/1,40	0,31/1,27/1,50	-1,50/-	-1,85/-	-2,77/-
	Ngrohje	Min./Nom./Max.	kW	0,25/0,64/0,95	0,25/0,75/1,11	0,25/0,94/1,50	0,25/1,24/1,40	-1,62/-	-1,63/-	-2,21/-
Ftohja e hapësirës	Klasë e efikasitetit të energjisë					A++			A++	
	Kapaciteti	Pdesign	kW	2,00	2,50	3,50	4,20	5,00	6,00	7,10
	SEER				6,50		6,21	6,15	5,15	
	Konsumi vjetor i energjisë		kWh/a	108	135	188	226	282	342	483
Ngrohja hapësirës (klima mesatare)	Klasë e efikasitetit të energjisë					A++			A++	
	Kapaciteti	Pdesign	kW	2,20	2,40	2,60	3,30	4,60	4,80	6,20
	SCOP/A			4,11		4,30	4,06		3,81	
	Konsumi vjetor i energjisë		kWh/a	749	817	885	1.075	1.585	1.654	2.275

Njësia e brendshme		FTXF	20E	25E	35E	42E	50D	60D	71D	
Dimensione	Njësi LartësiaxGjerësiaxThellësia	mm		286x770x225			295x990x263			
Filter ajri	Uloji			I lëvizshëm/lahet lehtësisht						
Niveli i presionit të zërit	Ftohja	E heshtur /e ulët /emesme / e lartë	dBA	20/25/33/39	20/26/33/40	20/27/34/43	22/30/36/45	31/34/39/43	33/36/41/45	34/37/42/46
	Ngrohje	E heshtur /e ulët /e mesme / e lartë	dBA	21/28/34/39	21/28/34/40	21/29/35/40	22/28/34/44	30/33/38/42	32/35/40/44	33/36/41/45

Njësia e jashtme		RXF	20E	25E	35E	42E	50D	60D	71D
Dimensione	Njësi LartësiaxGjerësiaxThellësia	mm		550x658x275			734x870x373		
Niveli i presionit të zërit	Ftohja	Nom./I lartë	dBA	-46		-48	47/-	49/-	52/-
	Ngrohje	Nom./I lartë	dBA	-47		-48	49/-		52/-
Gama e funksionimit	Ftohja	Ambienti	°CDB			-10~48			
	Ngrohje	Ambienti Min.~Maks.	°CDB			-15~24			
Ftohës	Lloji / GWP / Ngarkesa	kg/TCO ₂ Eq	R-32/675/0.45/0.30		R-32/675/0.55/0.37	R-32/675/0.75/0.51	R-32/675/0.90/0.61		R-32/675/1.15/0.78
Lidhjet e tubacioneve	Gjatësia e tubacionit	OU – IU Maks.	m		20		30		
	Dallimi në nivel	IU - OU Maks.	m		12		20		
Furnizimi me energji elektrike	Faza /Amplifikuesit maksimal të sigurave (MFA)	A		1~ / 16			1~ / 20		

Panele Diellore

Ngrohje & Ftohje

Hidraulike

Hidrosanitare

Aksesore të ndryshëm



Mono-Split Daikin Sensira FTXC-RXC

Daikin zgjidhje kondicionimi për shtëpinë tuaj

Sensira FTXC

Kondicioner me montim në mur



Karakteristikat dhe funksionet

Funksionet	Pastrimi i ajrit	Kontroll dhe planifikim
 		 
		opsionale



Të dhënat e efikasitetit		FTXC + RXC	20C + 20C	25C + 25C	35C + 35C	50C + 50C	60C + 60C	71C + 71C	
Kapaciteti ftohës	Min./Vlerësuar/Maks.	kW	1,3/2,0/3,0		1,3/3,5/4,0	1,4/5,1/6,2	1,8/6,23/7,0	2,3/7,1/7,3	
Kapaciteti i ngrohjes	Min./Vlerësuar/Maks.	kW	1,3/2,5/4,0		1,3/2,84/4,0	1,36/5,62/6,6	1,48/6,4/8,0	2,3/7,1/7,3	
Ftohja e hapësirës	Klasie efikasitetit të energjisë				A++			A++	
	Fuqia hyrëse	Pdesign	kW	2,08	2,57	3,44	5,08	6,21	6,96
	SEER			6,89	6,84	6,87	6,45	6,40	5,30
	Konsumi vjetor i energjisë		kWh/a	106	132	175	276	340	459
Ngrohja e hapësirës (klima mesatare)	Klasie efikasitetit të energjisë				A++			A++	
	Kapaciteti	Pdesign	kW	1,87	2,23	2,24	3,90	4,10	6,35
	SCOP/A			4,40	4,45	4,28	4,42	4,24	3,81
	Konsumi vjetor i energjisë		kWh/a	594	700	732	1.236	1.354	2.334

Njësia e brendshme			FTXC	20C	25C	35C	50C	60C	71C
Dimensione	Njësia	Lartësi x Gjerësi x Thellësia	mm	288x770x234			297x990x273		
Filter ajri	Lloji	I lëvizshëm/lahet lehtësisht							
Niveli i presionit të zërit	Ftohja	E heshtur / e ulët / e mesme / e lartë	dB(A)	20/26/33/38		21/26/34/39	29/33/39/45	30/38/42/46	

Njësia e jashtme			RXC	20C	25C	35C	50C	60C	71C
Dimensione	Njësia	Lartësi x Gjerësi x Thellësia	mm	550x658x273			615x845x300		695x930x350
Niveli i presionit të zërit	Ftohja	Lartë	dB(A)	45		46	51	54	
Gama e funksionimit	Ftohja	Ambienti Min.~Maks.	°CDB	10~46		-15~24		-10~46	
Ftohës	Ngrohje	Ambienti Min.~Maks.	°CDB						
Lidhjet e tubacioneve	Lloji / GWP / Ngarkesa		kg/TCO ₂ Eq	R-32/675/0,550/0,371		R-32/675/0,750/0,505	R-32/675/1,00/0,675	R-32/675/1,10/0,743	R-32/675/1,15/0,776
Dallimi në nivel	Gjatësia e tubacionit	OU - IU Maks.	m	20		8		30	
	Dallimi në nivel	IU - OU Maks.	m	15				20	
Furnizimi me energji elektrike	Faza / Amplifikuesit maksimal të siguresave (MFA)		A			1~ /16			



Mono-Split/Multi-Split Daikin Comfora FTXP-RXP

Daikin zgjidhje kondicionimi për shtëpinë tuaj

Comfora FTXP

Kondicioner me montim në mur



Karakteristikat dhe funksionet

Efikasiteti	Funksionet	Pastrimi i ajrit
Rrjedha e ajrit	Kontroll dhe planifikim	Funksione të tjera



Të dhënat e efikasitetit		FTXP + RXP	20M9 + 20M	25M9 + 25M	35M9 + 35M	50M + 50M	60M + 60M	71M + 71M	
Kapaciteti ftohës	Min./Nom./Max.	kW	1,3/2,0/2,6	1,3/2,5/3,0	1,3/3,5/4,0	1,7/5,0/6,0	1,7/6,0/7,0	2,3/7,1/7,3	
Kapaciteti i ngrohjes	Min./Nom./Max.	kW	1,3/2,5/3,5	1,3/3,0/4,0	1,3/4,0/4,8	1,7/6,0/7,7	1,7/7,0/8,0	2,3/8,2/9,0	
Fuqia hyrëse	Ftohja	Min./Num./Maks.	kW	0,31/0,50/0,72	0,31/0,65/0,72	0,29/1,01/1,30	0,320/1,385/1,826	0,332/1,824/2,980	0,449/2,689/3,274
	Ngrohje	Min./Num./Maks.	kW	0,25/0,52/0,95	0,25/0,69/0,95	0,29/1,00/1,29	0,440/1,579/2,356	0,456/1,928/2,787	0,617/2,571/3,306
Ftohja e hapësirës	Klasi e efikasitetit të energjisë								
	Kapaciteti	Pdesign	kW	2,00	2,50	3,50	5,0	6,0	7,1
	SEER			6,79	6,92	6,62	7,30	6,82	6,20
	Konsumi vjetor i energjisë		kWh/a	103	126	186	240	308	401
Ngrohja e hapësirës (klima mesatare)	Klasi e efikasitetit të energjisë								
	Kapaciteti	Pdesign	kW	2,20	2,40	2,80	4,60	4,80	6,20
	SCOP/A			4,65	4,61	4,64	4,40	4,10	4,01
	Konsumi vjetor i energjisë		kWh/a	662	728	845	1.463	1.638	2.166

Njësia e brendshme			FTXP	20M9	25M9	35M9	50M	60M	71M
Dimensione	Njësia	Lartësi x Gjerësi x Thellësia	mm		286x770x225			295x990x263	
Filter ajri	Lloji			I lëvizshëm/lahet lehtësisht					
Niveli i presionit të zërit	Ftohja	E heshtur / e ulët / e mesme / e lartë	dB(A)	19/25/33/39	19/26/33/40	20/27/34/43	27/34/39/43	30/36/41/45	32/37/42/46
	Ngrohje	E heshtur / e ulët / e mesme / e lartë	dB(A)	21/28/34/39	21/28/34/40	21/29/35/40	30/36/36/41	32/35/40/44	33/36/41/45

Njësia e jashtme			RXF	20D	25D	35D	42D	50D	60D	71D
Dimensione	Njësia	Lartësi x Gjerësi x Thellësia	mm		550x658x275				734x870x373	
Niveli i presionit të zërit	Ftohja	Nom./I lartë	dB(A)	-/46			-/48	47/-	49/-	52/-
	Ngrohje	Nom./I lartë	dB(A)	-/47			-/48	49/-		52/-
Gama e funksionimit	Ftohja	Ambienti Min.~Maks.	°CDB				-10~48			
	Ngrohje	Ambienti Min.~Maks.	°CDB				-15~24			
Ftohës	Lloji / GWP / Ngarkesa		kg/TCO _{Eq}	R-32/675/0.45/0.30		R-32/675/0.55/0.37	R-32/675/0.75/0.51	R-32/675/0.90/0.61	R-32/675/1.15/0.78	
Lidhjet e tubacioneve	Gjatësia e tubacionit	OU - IU Maks.	m		20				30	
	Diametri i tubacionit	IU - OU Maks.	m		12				20	
Furnizimi me ener- elektrike	Faza / Amplifikuesit maksimal të sigu- resave (MFA)		A		1~ / 16				1~ / 20	

Panele Diellore

Ngrohje & Ftohje

Hidraulike

Hidrosanitare

Aksesore të ndryshëm



Mono-Split / Multi-Split Daikin Perfera FVXM-A / RXM-R9

Daikin zgjidhje kondicionimi për shtëpinë tuaj

Perfera FVXM

Kondicioner ne dysHEME



Karakteristikat dhe funksionet

Efikasiteti	Funksionet				Pastrimi i ajrit	
Kontroll dhe planifikim	Funksione të tjera					
i integruar						



FVXM-A9



RXM-R9



ARC466A66



Integrated

Të dhënat e efikasitetit		C/FVXM + RXM	CVXM20A	25A9 + 25R9	35A9 + 35R9	50A9 + 50R	
Kapaciteti ftohës	Min./Nom./Max.	kW		1,3/2,4/3,5	1,4/3,4/4,0	1,4/5,0/5,8	
Kapaciteti i ngrohjes	Min./Nom./Max.	kW		1,3/3,4/4,7	1,4/4,5/5,8	1,4/5,8/8,1	
Fuqia hyrëse	Ftohja	Nom.	kW	0,54	0,85	1,31	
	Ngrohje	Nom.	kW	0,75	1,15	1,52	
Ftohja e hapësirës	Klasi e efikasitetit të energjisë		E përputhshme vetëm me njësi të jashtme multi	A+++	A++	A+	
	Kapaciteti	Pdesign		kW	2,40	3,40	5,00
	SEER				8,55	8,11	7,30
	Konsumi vjetor i energjisë			kWh/a	98	147	240
Ngrohja e hapësirës (klima mesatare)	Klasi e efikasitetit të energjisë		E përputhshme vetëm me njësi të jashtme multi	A++	A+	A	
	Kapaciteti	Pdesign		kW	2,30	2,80	4,10
	SCOP/A				4,65	4,63	4,31
	Konsumi vjetor i energjisë			kWh/a	693	847	1.330

Njësia e brendshme			C/FVXM	CVXM20A	25A	35A	50A
Dimensione	Njësia	Lartësi x Gjerësi x Thellësia	mm				600x750x238
Filter ajri	Lloji		I lëvizshëm/lahet lehtësisht				
Niveli i presionit të zërit	Ftohja	E heshtur /e ulët /e mesme /e lartë	dBa	22/25/32/38	20/25/32/38	20/25/32/39	27/31/38/44
	Ngrohje	E heshtur /e ulët /e mesme /e lartë	dBa	21/25/32/38	19/25/32/38	19/25/32/39	29/35/40/46

Njësi e jashtme			RXM	25R9	35R9	50R	
Dimensione	Njësia	Lartësi x Gjerësi x Thellësia	mm				552x840x350 / 734x954x401
Niveli i presionit të zërit	Ftohja	Nom.	dBa	46	49	48	
	Ngrohje	Nom.	dBa	47	49	48	
Gama e funksionimit	Ftohja	Ambienti Min.~Maks.	°CDB	-10~46			
	Ngrohje	Ambienti Min.~Maks.	°CDB	-15~24			
Ftohës	Lloji / GWP / Ngarkesa		kg/TCO ₂ /Eq	R-32/675/0,76/0,52		R-32/675/0,115/0,780	
Lidhjet e tubacioneve	Gjatësia e OU -IU	Maks.	m	20			
	tubacionit Sistemi	E pa karikueshme	m	10			
	Dihërit IU -OU	Maks.	m	15			
Furnizimi me energji elektrike	Faza / Amplifikuesit maksimal të siguresave (MFA)		A	1~ / 13		1~ / 16	



Mono-Split / Multi-Split Daikin Perfera FTXM-A / RXM-R9

Daikin zgjidhje kondicionimi për shtëpinë tuaj

Perfera FTXM

Kondicioner me montim në mur



Karakteristikat dhe funksionet

Efikasiteti	Funksionet	Pastrimi i ajrit
Fluksi i ajrit	Kontroll dhe planifikim	Funksione të tjera
	i integruar	



Panele Diellore

Ngrohje & Ftohje

Të dhënat e efikasitetit		FTXM+RXM	CTXM15R	20R+20R9	25R+25R9	35R+35R9	42R+42R	50R+50R	60R+60R	71R+71R
Kapaciteti ftohës	Min./Nom./Max.	kW		1,3/2,0/2,6	1,3/2,5/3,2	1,4/3,4/4,0	1,7/4,2/5,0	1,7/5,0/6,0	1,7/6,0/7,0	2,3/7,1/8,5
Kapaciteti i ngrohjes	Min./Nom./Max.	kW		1,3/2,5/3,5	1,3/2,8/4,7	1,4/4,0/5,2	1,7/5,4/6,0	1,7/5,8/7,7	1,7/7,0/8,0	2,3/8,2/10,2
Fuqia hyrëse	Ftohja	Nom.	kW	0,44	0,56	0,80	0,97	1,36	1,77	2,34
	Ngrohje	Nom.	kW	0,50	0,56	0,99	1,31	1,45	1,94	2,57
Ftohja e hapësirës	SEER			2,00	2,50	3,40	4,20	5,00	6,00	7,10
	Konsumi vjetor i energjisë	kWh/a		81	101	137	187	236	304	401
	Klasi i efikasitetit të energjisë				A+++			A++		A+
Ngrohja e hapësirës (klima mesatare)	Kapaciteti	Pdesign	kW	2,30	2,40	2,50	4,00	4,60	4,80	6,20
	SCOP/A			5,10			4,71		4,30	4,10
	Konsumi vjetor i energjisë	kWh/a		631	659	686	1.189	1.368	1.562	2.117

Njësia e brendshme		FTXM	CTXM15R	20R	25R	35R	42R	50R	60R	71R			
Dimensione	Njësia	Lartësi x Gjerësi x Thellësia		mm			295x778x272		299x998x292				
Filter ajri	Lloji	I lëvizshëm / I ahët lehtësisht											
Niveli i presionit të zërit	Ftohja	E heshtur / e ulët / e mesme / e lartë			dBA		19/25/33/41	19/29/33/45	21/30/39/45	27/36/40/44	30/37/42/46	32/38/43/47	
	Ngrohje	E heshtur / e ulët / e mesme / e lartë			dBA		20/26/34/39	20/27/34/39	20/28/35/39	21/29/39/45	31/34/39/43	33/36/41/45	34/37/42/46

Njësia e jashtme		RXM	20R9	25R9	35R9	42R	50R	60R	71R	
Dimensione	Njësia	Lartësi x Gjerësi x Thellësia		mm			552x840x350		734x954x401	
Niveli i presionit të zërit	Ftohja	Nom.		dBA		46	49	48	47	
	Ngrohje	Nom.		dBA		47	49	48	48	
Gama e funksionimit	Ftohja	Ambienti Min.~Max.		°CDB		-10~50°C			-10~46°C	
	Ngrohje	Ambienti Min.~Max.		°CDB		-20~24°C				
Ftohës	Lloji / GWP / Ngarkesa	kg/TCO ₂ Eq		R-32/675/0,76/0,52		R-32/675/0,76/0,52		R-32/675/0,115/0,780		
Lidhjet e tubacioneve	Gjatësia e tubacionit	Sistemi E pa karikueshme		m		20		30		
	Dallimi i tubacionit	Max.		m		10		20		
Furnizimi me energji elektrike	Faza / Amplifikuesit maksimal të siguresave (MFA)	A		1~ / 10		1~ / 13		1~ / 16		1~ / 20

Hidraulike

Hidrosanitare

Aksesore të ndryshëm

Mono-Split / Multi-Split Daikin Emura FTXJ - AW/AS/AB + RXJ-A

Daikin zgjidhje kondicionimi për shtëpinë tuaj

Emura FTXJ

Kondicioner me montim në mur



Karakteristikat dhe funksionet

Efikasiteti	Funksionet	Pastrimi i ajrit
		
Rrjedha e ajrit	Kontroll dhe planifikim	Funksione të tjera
		



Te dhenat e efikasitetit			FTXJ/RXJ	20AW/S/B + 20A	25AW/S/B + 25A	35AW/S/B + 35A	42AW/S/B + 42A	50AW/S/B + 50A
Kapaciteti ftohës	Min./Nom./Max.	kW		1,3/2,0/2,6	1,3/2,5/3,2	1,4/3,4/4,0	1,7/4,2/5,0	1,7/5,0/5,3
Kapaciteti i ngrohjes	Min./Nom./Max.	kW		1,3/2,5/3,5	1,3/2,8/4,7	1,4/4,0/5,2	1,7/5,4/6,0	1,7/5,8/6,5
Fuqia hyrëse	Ftohja	Nom.	kW	0,43	0,56	0,78	1,05	1,36
	Ngrohje	Nom.	kW	0,50	0,56	0,99	1,34	1,49
Ftohja e hapësirës	Klasi e efikasitetit të energjisë				A+++			A++
	Kapaciteti	Pdesign	kW	2,0	2,5	3,4	4,2	5,0
	SEER			8,75	8,74	8,73	7,50	7,33
	Konsumi vjetor i energjisë		kWh/a	80	100	136	196	239
Ngrohja e hapësirës (klima mesatare)	Klasi e efikasitetit të energjisë				A+++			A++
	Kapaciteti	Pdesign	kW	2,40	2,45	2,50	3,80	4,00
	SCOP			5,15	5,15	5,15	4,60	4,60
	Konsumi vjetor i energjisë		kWh/a	652	666	680	1.156	1.218

Njësia e brendshme				FTXJ	20AW/S/B	25AW/S/B	35AW/S/B	42AW/S/B	50AW/S/B
Dimensione	Njësia	Lartësi x Gjerësi x Thellësia	mm				305x900x212		
Pesha	Njesia		kg				12		
Filter ajri	Lloji						I lëvizshëm/lahet lehtësisht		
Niveli i presionit të zërit	Ftohja	Funksionim i heshtur/1 ulët/Num./1 lartë	dBA	19/25/32/39	19/25/33/40	19/25/33/40	19/25/33/41	21/29/37/45	24/31/39/46
	Ngrohje	Funksionim i heshtur/1 ulët/Num./1 lartë	dBA	19/25/32/39	19/25/33/40	19/25/33/40	19/25/33/41	21/29/37/45	24/33/42/46

Njësi e jashtme					RXJ	20A	25A	35A	42A	50A
Dimensione	Njësia	Lartësi x Gjerësi x Thellësia	mm				552x840x350			734x954x401
Niveli i presionit të zërit	Ftohja	Nom.	dBA		46	46	49	48	48	48
	Ngrohje	Nom.	dBA		47	47	49	48	48	49
Gama e funksionimit	Ftohja	Ambienti	Min.~Max.	°CDB				-10~50°C		
	Ngrohje	Ambienti	Min.~Max.	°CDB				-20~24°C		
Ftohës	Lloji / GWP / Ngarkesa		kg/TCO ₂ Eq				R-32/675/0,76/0,52			R-32/675/0,1,10/0,75
Lidhjet e tubacioneve	Liquid/Gas OD						6,35/9,50			6,35/12,70
	Gjatësia e OU - IU	Max.	m				20		30	
	tubadonit Sistemi	Epa Karikueshme	m						10	
		Ngarkesa shtese e ftohesit	kg/m					0.02 (per gjatesin e tubave mbi 10m)		
Dallimi ne nivel	IU - OU	Max.	M				15			20
Furnizimi me energji elektrike	Faza / Frekuenc/Tension		Hz/V					1~ / 50/220-240		
Rryma – 50Hz	Amp.maksimal te siguresave (MFA)		A		10				13	



Mono-Split/Multi-Split Daikin Emura FTXA-AW/BS/BT/BB+RXA-A

Daikin zgjidhje kondicionimi për shtëpinë tuaj

Styllsh FTXA

Kondicioner me montim në mur



Karakteristikat dhe funksionet

Efikasiteti	Funksionet	Pastrimi i ajrit
Rrjedha e ajrit	Kontroll dhe planifikim	Funksione të tjera
 	 i integruara	



Te dhenat e efikasitetit	FTXA+RXA	CTXA15AW /BS/BT/BB	20AW/BS/BT/BB+ 20A9	25AW/BS/BT/BB + 25A	35AW/BS/BT/BB+ 35A	42AW/BS/BT/BB + 42A	50AW/BS/BT/BB + 50A
Kapaciteti ftohës	Min./Nom./Max. kW		1,3/2,0/2,6	1,3/2,5/3,2	1,4/3,4/4,0	1,7/4,2/5,0	1,7/5,0/5,3
Kapaciteti i ngrohjes	Min./Nom./Max. kW		1,3/2,5/3,5	1,3/2,8/4,7	1,4/4,0/5,2	1,7/5,4/6,0	1,7/5,8/6,5
Fuqia hyrëse	Ftohja Nom. kW	E përputhshm e vetëm menjësi të jashtme multi	0,27/0,43/0,63	0,27/0,56/0,78	0,31/0,78/1,04	-1,05/-	-1,36/-
	Ngrohje Nom. kW		0,25/0,50/0,91	0,25/0,56/1,22	0,26/0,99/1,67	-1,31/-	-1,45/-
Ftohja e hapësirës	Klasi e efikasitetit të energjisë			A+++		A++	
	Kapaciteti Pdesign kW		2,0	2,5	3,4	4,2	5,0
	SEER		8,75	8,74	8,73	7,50	7,33
	Konsumi vjetor i energjisë kWh/a		80	100	136	196	239
Ngrohja e hapësirës (klima mesatare)	Klasi e efikasitetit të energjisë			A+++		A++	
	Kapaciteti Pdesign kW		2,40	2,45	2,50	3,80	4,00
	SCOP		5,15	5,15	5,15	4,60	4,60
	Konsumi vjetor i energjisë kWh/a		653	666	680	1.150	1.217

Njësia e brendshme		FTXA	CTXA15AW/B S/BT/BB	20AW/BS/B T/BB	25AW/BS/B T/BB	35AW/BS/B T/BB	42AW/BS/B T/BB	50AW/BS/B T/BB	
Dimensione	Njësia	Lartësi x Gjerësi x Thellësia		mm					
Filter ajri	Lloji	305x900x212							
Niveli i presionit të zërit	Ftohja	Funksionim i heshtur/ ulët/Num./I lartë	dB(A)	21/25/32/39	19/25/32/39	19/25/33/40	19/25/33/41	21/29/37/45	24/31/39/46
	Ngrohje	Funksionim i heshtur/ ulët/Num./I lartë	dB(A)	21/25/32/39	21/25/32/39	19/25/33/40	19/25/33/41	21/29/37/45	24/33/42/46

Njësi e jashtme		RXA	20A9	25A9	35A9	42A9	50A9
Dimensione	Njësia	Lartësi x Gjerësi x Thellësi		mm			
Niveli i presionit të zërit	Ftohja	Nom.	552x840x350				734x870x373
	Ngrohje	Nom.	46				48
Gama e funksionimit	Ftohja	Ambienti Min.~Max.	-10~46°C				
	Ngrohje	Ambienti Min.~Max.	-15~24°C				
Ftohës	Lloji / GWP / Ngarkesa	kg/TCO ₂ Eq	R-32/675/0,76/0,52				R-32/675,0/1,10/0,75
Lidhjet e tubacioneve	Gjatësia e tubacionit	OU - IU Max.	20				30
	Dallimi ne nivel	IU - OU Max.	15				20
Furnizimi me energji elektrike	Faza / Amplifikuesit maksimal te siguresave (MFA)	A	1~ / 10		1~ / 13		

Panele Djellore

Ngrohje & Ftohje

Hidraulike

Hidrosanitare

Aksesore të ndryshëm

Multi-Split Daikin Kasete FCAG-B

Daikin zgjidhje kondicionimi për shtëpinë tuaj

FCAG-B

Kondicioner kasete

deri në

A++

deri në

A+

Karakteristikat dhe funksionet

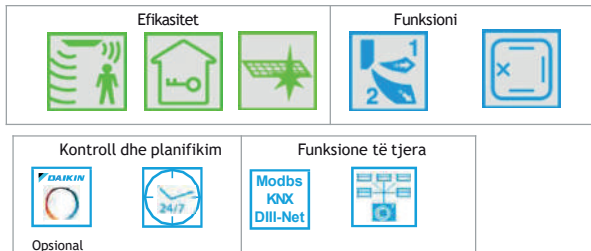

Panele Diellore

Ngrohje & Ftohje

Hidraulike

Hidrosanitare

Aksesore të ndryshëm

Të dhënat e efikasitetit	FCAG+RZAG	35B+35A	50B+50A	60B+60A	71B+71NV1	100B+100NV1	125B+125NV1	140B+140NV1	71B+71NY1	100B+100NY1	125B+125NY1	140B+140NY1		
Kapaciteti ftohës	Min./Nom./Max.	KW	1.6/3.5/4.5	1.7/5.0/6.0	1.7/6.0/6.5	-/6.80/-	-/9.50/-	-/12.1/-	-/13.4/-	-/6.80/-	-/9.50/-	-/12.1/-	-/13.4/-	
Kapaciteti i ngrohjes	Min./Nom./Max.	KW	14/40/50	1.50/5.80/6.0	1.60/7.00/7.5	-/7.50/-	-/10.8/-	-/13.5/-	-/15.5/-	-/7.50/-	-/10.8/-	-/13.5/-	-/15.5/-	
Ftohja e hapësirës	Klasi e efikasitetit të energjisë A++													
	Kapaciteti	Pdesign	KW	3.50	5.00	6.00	6.80	9.50	12.1	13.4	6.80	9.50	12.1	13.4
	SEER			7.30	6.80	6.60	6.83	7.14	7.15	6.80	6.83	7.14	7.15	6.80
	ηs,h	%							283	269			283	269
	Konsumi vjetor i energjisë	kWh/a		168	257	318	348	466	1,016	1,182	348	466	1,016	1,182
Ngrohja e hapësirës (klime mesatare)	Klasi e efikasitetit të energjisë A+													
	Kapaciteti	Pdesign	KW	3.30	4.30	4.60	4.70	7.80	9.52	9.52	4.70	7.80	9.52	9.52
	SCOP/A			4.30	4.30	4.25	4.22	4.53	4.34	4.34	4.22	4.53	4.34	4.34
	ηs,h	%							171	171			171	171
	Konsumi vjetor i energjisë	kWh/a		1,074	1,398	1,515	1,560	2,413	3,071	3,071	1,560	2,413	3,071	3,071

Njesia e brenshme	FCAG	35B	50B	60B	71B	100B	125B	140B	71B	100B	125B	140B		
Dimensionet	Lartesia x Gjersia x Thellesia	mm	204x840x840				246x840x840		204x840x840		246x840x840			
Pesha	Njesi	Kg	18	19	21	23		21		23				
Filter ajri	Lloji	Rrjete rreshire												
Modeli panelit te dekorimit	Panel Standart:BYCQ140E-E bardhe me grille gri/BYCQ140EW-E bardhe e plote/BYCQ140EB -Panel i zi me pastrim automatic/BYCQ140EGF -E Bardhe /BYCQ140EGFB -Panel i zi me dizanje/BYCQ140EP -E bardhe/BYCQ140EPB-E zeze													
	Dimension	Lartesia x Gjersia x Thellesia	Panel Standart:65x950x950/ Panel me patrim automatic:148x950x950 / Panel me dizanje:106x950x950											
	Pesha	KG	Panel standart:5.5 / Panel me patrim automatic:10.3 / Panel me dizanje:6.5											
Fan shkalla e rrjedhes se ajrit	Ftohje	Eulët/emesme/elartë	8.8/10.6/12.9				9.4/11.8/14.1		11.8/14.6/18.2		12.2/14.9/18.3		15.1/18.0/22.7	
	Ngrohje	Eulët/emesme/elartë	9.4/11.8/14.1				11.8/14.6/18.2		12.2/14.9/18.3		15.1/18.0/22.7		18.1/23.0	
Niveli i fuqise se zerit	Ftohje	dBA	49.0				51.0		54.0		58.0		58.0	
	Ngrohje	dBA	49.0				51.0		54.0		58.0		58.0	
Niveli i presionit te zerit	Ftohje	Eulët/emesme/elartë	27.0/29.0/31.0				28.0/31.0/33.0		28.0/31.0/35.0		29.0/33.0/37.0		29.0/35.0/41.0	
	Ngrohje	Eulët/emesme/elartë	27.0/29.0/31.0				28.0/31.0/33.0		29.0/33.0/37.0		29.0/35.0/41.0		28.0/31.0/33.0	
Sistemet e kontrollit	Telekomand infra te kuqe	BRC7FA532F / BRC7FB532F / BRC7FA532FB / BRC7FB532FB												
	Telekomand me tela	BRC1D528/BRC1E53A7 / BRC1E53B7 / BRC1E53C7 / BRC1H81W/S / BRC1H51(9)W/S/K7 / BRC2E52C7 / BRC3E52C7												
Furnizimi me energji elektrike	Faz/Frekuenca/Tensioni	1~/ 50/60/220-240/220												

Multi-Split Daikin Kasete FFA-A9

Daikin zgjidhje kondicionimi për shtëpinë tuaj

FFA - A9

Kondicioner kasete



Karakteristikat dhe funksionet

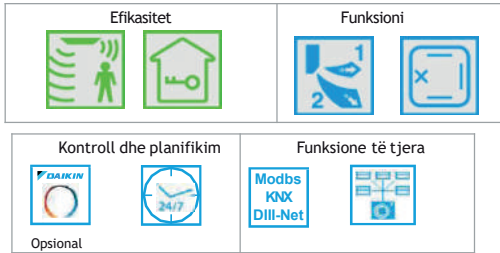

Panele Diellore

Ngrohje & Ftohje

Hidraulike

Hidrosanitare

Aksesore të ndryshëm

Të dhënat e efikasitetit		FFA+RZAG	35A9+35A	50A9+50A	60A9+60A
Kapaciteti ftohës	Min./Nom./Max.	KW	1.6 /3.5 /4.5	1.7 /5.0 /6.0	1.7 /6.0 /6.5
Kapaciteti i ngrohjes	Min./Nom./Max.	KW	1.40 /4.00 /5.00	1.50 /5.80 /6.00	1.60 /7.00 /7.50
Ftohja e hapësirës	Klasi e efikasitetit të energjisë			A++	A++
	Kapaciteti Pdesign	kW	3.50	5.00	6.00
	SEER		6.40	6.30	5.80
	Konsumi vjetor i energjisë	kWh/a	191	278	362
Ngrohja e hapësirës (klima mesatare)	Klasi e efikasitetit të energjisë		A	A+	
	Kapaciteti Pdesign	kW	4.20	4.30	4.50
	SCOP/A		3.80	4.01	4.04
	Konsumi vjetor i energjisë	kWh/a	1,549	1,501	1,558

Indoor unit		FFA	35A9	50A9	60A9	
Dimensionet	Lartësia x Gjersia x Thellessia	mm		260x575x575		
Pesha	Njesi	kg	16.0		17.5	
Filtri ajrit	Lloji			Rrjete rreshire		
Paneli i dekoruar	Model		BYFQ60C2W1W / BYFQ60C2W1S / BYFQ60B2W1 / BYFQ60B3W1			
	Ngjyra		E bardhe (N9.5)/Argjendi/E bardhe (RAL9010)/E bardhe (RAL9010)			
	Lartësia x Gjersia x Thellessia	mm	46x620x620 / 46x620x620 / 55x700x700 / 55x700x700			
	Pesha	kg	2.8 /2.8 /2.7 /2.7			
Fan	shkalla e ajrit	Ftohje E ulët / e mesme / e lartë	m³/min	6.5/8.5/10.0	8.6 / 10.9 / 12.7	9.5/12.5 / 14.5
		Ngrohje E ulët / e mesme / e lartë	m³/min	6.5/8.5/10.0	8.6 / 10.9 / 12.7	9.5/12.5 / 14.5
Niveli i fuqisë së zërit	Ftohje	dBA	51.0	56.0	60.0	
Niveli i presionit të zërit	Ftohje	E ulët / e mesme / e lartë	dBA	25.0 / 30.5 / 34.0	27.0 / 34.0 / 39.0	32.0 / 40.0 / 43.0
	Ngrohje	E ulët / e mesme / e lartë	dBA	25.0 / 30.5 / 34.0	27.0 / 34.0 / 39.0	32.0 / 40.0 / 43.0
Sistemi i kontrollit	Telekomand infra te kuqe		BRC7E8530W (Panel standart) / BRC7F530W (Panel i bardhe) / BRC7F530s (Panel gri)			
	Telekomand me tela		BRC1H52W/S/K / BRC1E53A / BRC1E53B / BRC1E53C / BRC1D52			
Furnizimi me energji elektrike	Faz/Frekuenca/Tensioni	Hz/V	1~/50/220-240			

Multi-Split Daikin Tavanore FHA-A9

Daikin zgjidhje kondicionimi për shtëpinë tuaj

FHA-A9

Kondicioner tavanore

deri në



deri në



Karakteristikat dhe funksionet

Efikasitet	Funksioni
	
Kontroll dhe planifikim	Funksione të tjera
 	 
Opsional	



Të dhënat e efikasitetit	FHA+RZAG	35A+35A	50A+50A	60A9+60A	71A9+71NV1	100A+100NV1	125A+125NV1	140A+140NV1	71A9+71NY1	100A+100NY1	125A+125NY1	140A+140NY1	
Kapaciteti ftohës Min./Nom./Max.	KW	1.7/3.5/4.5	1.7/5.0/6.0	1.9/6.0/6.8	-/6.80/-	-/9.50/-	-/12.1/-	-/13.4/-	-/6.80/-	-/9.50/-	-/12.1/-	-/13.4/-	
Kapaciteti i ngrohjes Min./Nom./Max.	KW	14/4.00/5.00	1.50/5.80/6.5	1.70/7.00/7.5	-/7.50/-	-/10.8/-	-/13.5/-	-/15.5/-	-/7.50/-	-/10.8/-	-/13.5/-	-/15.5/-	
Ftohja e hapësirës	Klasi e efikasitetit të energjisë												
	Kapaciteti Pdesign	KW	3.50	5.00	6.00	6.80	9.50	12.1	13.4	6.80	9.50	12.1	13.4
	SEER		6.40	6.80	6.60	7.11	6.42	7.14	6.42	7.11	6.42	7.15	6.80
	ηs,h	%						283	254			283	254
	Konsumi vjetor i energjisë kWh/a		191	257	318	335	518	1,017	1,253	335	518	1,017	1,253
Ngrohja e hapësirës (klime mesatare)	Klasi e efikasitetit të energjisë												
	Kapaciteti Pdesign	KW	3.10	4.00	4.60	4.70	7.80	9.52	9.52	4.70	7.80	9.52	9.52
	SCOP/A		4.10	4.30	4.20	4.32	4.61	4.20	4.30	4.32	4.61	4.20	4.30
	ηs,h	%						165	169			165	165
	Konsumi vjetor i energjisë kWh/a		1,058	1,302	1,633	1,523	2,369	3,174	3,100	1,523	2,369	3,174	3,100

Njesia e brenshme	FHA	35A9	50A9	60A9	71A9	100A	125A	140A	71A9	100A	125A	140A	
Dimensionet	Lartesia x Gjersia x Thellesia	mm	235x960x690		235x1,270x690		235x1,590x690		235x1,270x690		235x1,590x690		
Pesha	Njesi	Kg	24	25	31	32	38		32		38		
Filter ajri	Lloji	Rrjete rreshire											
Fan shkalla e rrjedhes se ajrit	Ftohje	E ulët/emesme/elartë	10.0/11.5/14	10.0/12.0/15.0	11.5/15.0/19.5	14.0/17.0/20.5	20.0/24.0/28.0	23.0/27.0/31.0	24.0/29.0/34.0	14.0/17.0/20.5	20.0/24.0/28.0	23.0/27.0/31.0	24.0/29.0/34.0
	Ngrohje	E ulët/emesme/elartë	10.0/11.5/14	10.0/12.0/15.0	11.5/15.0/19.5	14.0/17.0/20.5	20.0/24.0/28.0	23.0/27.0/31.0	24.0/29.0/34.0	14.0/17.0/20.5	20.0/24.0/28.0	23.0/27.0/31.0	24.0/29.0/34.0
Niveli i fuqise se zerit	Ftohje	dBA	53	54	55	60	62	64	55	60	62	64	
Niveli i presionit te zerit	Ftohje	E ulët/emesme/elartë	31/34/36	32/35/37	33/35/37	34/36/38	34/38/42	37/41/44	38/42/46	38/42/46	38/42/46	38/42/46	38/42/46
	Ngrohje	E ulët/emesme/elartë	31/34/36	32/35/37	33/35/37	34/36/38	34/38/42	37/41/44	38/42/46	38/42/46	38/42/46	38/42/46	38/42/46
Sistemet e kontrollit	Telekomand infra te kuqe												
	Telekomand me tela												
Furnizimi me energji elektrike	BRC7GA53 / BRC7GA56												
	BRC1E53A7/BRC1E53B7 / BRC1E53C7 / BRC1D528 / BRC1E51A7												
Faz/Frekuenca/Tensioni													
1~ / 50/220-240													



Mono-Split /Multi-Split Daikin Sky Air FDXM-RXM

Daikin zgjidhje kondicionimi për shtëpinë tuaj

FDXM-F9

Kondicioner i fshehur



Karakteristikat dhe funksionet

Efikasiteti Opsione	Pastrimi i ajrit 	Kontroll dhe planifikim 	Funksione të tjera
-------------------------------	-----------------------------	------------------------------------	-------------------------------



Panele Diellore

Ngrohje & Ftohje

Të dhënat e efikasitetit	FDXM + RXM	25F9 + 25R9	35F9 + 35R9	50F9 + 50R	60F9 + 60R
Kapaciteti ftohës	Min./Nom./Max. kW	1,3/2,4/3,0	1,4/3,4/3,8	1,7/5,0/5,3	1,7/6,0/6,5
Kapaciteti i ngrohjes	Min./Nom./Max. kW	1,3/3,2/4,5	1,4/4,0/5,0	1,7/5,8/6,0	1,7/7,0/7,1
Fuqia hyrëse	Ftohja Nom. kW	0,64	1,14	1,63	2,05
	Ngrohje Nom. kW	0,80	1,15	1,87	2,18
Ftohja e hapësirës	Klasie efikasitetit të energjisë				
	Kapaciteti Pdesign kW	2,40	3,40	5,00	6,00
	SEER	5,68	5,26	5,77	5,56
	Konsumi vjetor i energjisë kWh/a	148	226	303	378
Ngrohja e hapësirës (klima mesatare)	Klasie efikasitetit të energjisë				
	Kapaciteti Pdesign kW	2,60	2,90	4,00	4,60
	SCOP/A	4,24	3,88	3,93	3,80
	Konsumi vjetor i energjisë kWh/a	858	1.046	1.424	1.693

Njësia e brendshme	FDXM	25F9	35F9	50F9	60F9
Dimensione	Njësia Lartësi x Gjerësi x Thellësia mm	200x750x620		200x1.150x620	
Filter ajri	Lloji		I lëvizshëm/lahet lehtësisht		
Ventilator - Presion i jashtëm statik	Nom. Pa	30		40	
Niveli i presionit të zërit	Ftohja Ngrohje	E ulët / e mesme / e lartë	27/33/35	30/35/38	30/35/38
		E ulët / e mesme / e lartë	27/33/35	30/35/38	30/35/38

Njësia e jashtme	RXM	25R9	35R9	50R	60R
Dimensione	Njësia Lartësi x Gjerësi x Thellësia mm	552x840x350		734x954x401	
Niveli i presionit të zërit	Ftohja Ngrohje	Nom. dBA	46 47	49 49	48,0 49,0
Gama e funksionimit	Ftohja Ngrohje	Ambienti Min.~Maks. °CDB		-10~46 -15~24	
Ftohës	Lloji / GWP / Ngarkesa	kg/ TCO ₂ Eq	R-32/675/0,76/0,52	R-32/675,0/1,15/0,78	
Lidhjet e tubacioneve	Gjatësia e tubacionit Sistemi Dallimi në nivel	OU - IU Maks. E pakarikueshme IU - OU Maks. m	20 15	30 10 20	
Furnizimi me energji elektrike	Faza / Amplifikuesit maksimal të siguresave (MFA)	A	1~ / 13	1~ / 16	

Hidraulike

Hidrosanitare

Aksesore të ndryshëm



Multi-Split Daikin Sky Air FNA-RZAG

Daikin zgjidhje kondicionimi për shtëpinë tuaj

FNA-A9

Kondicioner i fshehur



Karakteristikat dhe funksionet

Efikasiteti	Kontroll dhe planifikim	Funksione të tjera



FNA-A9

BRC1H52W

BRP069C81

Të dhënat e efikasitetit		FNA + RZAG	35FA9 + 35A	50A9 + 50A	60A9 + 60A
Kapaciteti ftohës	Min./Nom./Max.	kW	1.6/3.5/4.5	1.7/5.0/6.0	1.7/6.0/6.5
Kapaciteti i ngrohjes	Min./Nom./Max.	kW	1.40/4.00/5.00	1.70/5.00/6.00	1.70/7.00/7.50
Ftohja e hapësirës	Klasi e efikasitetit të energjisë				
	Kapaciteti Pdesign	kW	3,50	5,00	6,00
	SEER		5.90		5.70
	Konsumi vjetor i energjisë	kWh/a	208	297	368
Ngrohja e hapësirës (klima mesatare)	Klasi e efikasitetit të energjisë				
	Kapaciteti Pdesign	kW	3.50	4.30	4.50
	SCOP/A			3.90	
	Konsumi vjetor i energjisë	kWh/a	1.255	1.542	1.616

Njesia e bremsme		FNA	35A9	50A9	60A9
Dimensionet	Lartesia x Gjeria x Thellesia mm		620/720x790x200		620/720/1,190/200
Pesha	Njesi Kg		23		30
Filter ajri	Lloji				Rrjete rreshire
Fan shkalla e rrjedhes se ajrit	Ftohje E ulët/emesme/elartë	m ³ /min	7.3/8.7		13.5/16.0
	Ngrohje E ulët/emesme/elartë	m ³ /min	7.3/8.7		13.5/16.0
	Statistike e jashtme presioni	Nom./I larte Pa	30/48		40/49
Niveli i fuqise se zerit	Ftohje	dBa	53		56
Niveli i presionit te zerit	Ftohje E ulët/emesme/elartë	dBa	28.0/31.0/33.0		30.0/33.0/36.0
	Ngrohje E ulët/emesme/elartë	dBa	28.0/31.0/33.0		30.0/33.0/36.0
Sistemet e kontrollit	Telekomand infra te kuqe				BRC4C65
	Telekomand me tela				BRC1H52W/S/K / BRC1E53A / BRC1E53B / BRC1E53C / BRC1D52
Furnizimi me energji elektrike	Faz/Frekuenca/Tensioni				1~ / 50/60/220-240/220



Multi-Split Njesi e jashtme

Daikin zgjidhje kondicionimi për shtëpinë tuaj

Aplikim me shumë modele 2/3/4/5MXM-A



- Nga 2 deri ne 5 njësi të brendshme mund të lidhen me 1 multi njësi të jashtme;

- Të gjitha njësitë e brendshme janë të kontrollueshme individualisht dhe nuk kanë nevojë të instalohen në të njëjtën dhomë ose në të njëjtën kohë. Njësitë e brendshme funksionojnë njëkohësisht brenda të njëjtit modalitet ngrohjeje ose ftohjeje



2MXM-A



3/4/5MXM-A

Njësi e jashtme				2MXM40A	2MXM50A	2MXM68A	3MXM40A	3MXM52A	3MXM68A	4MXM68A	4MXM80A	5MXM90A	
Dimensione	Njësi	Lartësi x Gjerësi x thellësi	mm	552x852x350	734x958x340	734x974x401	734x958x340						
Niveli i fuqisë së zërit	Ftohja			60	61	59	61					64	
Niveli i presionit të zërit	Ftohja	Nom.	dB(A)	46	48	48	46	48					52
	Ngrohje	Nom.	dB(A)	48	50	48	47	-	49		52		
Gama e funksionimit	Ftohja	Ambienti	Min.~Maks.	°CDB			-10~46						
	Ngrohje	Ambienti	Min.~Maks.	°CDB			-15~24						
Ftohës	Lloji/ GWP/Tarifë		kg/TCO ₂ Eq	R-32	R-32	R-32	R-32/675/1,80/1,22		R-32/675/2,00/1,35		R-32/675/2,40/1,62		
			mm	6,4	6,35	6,4	6,35						
Lidhjet e tubacioneve	Gas	OD	mm	9,5	9,50	9,5	9,50						
	Gjatësia e tubacit	OU-IU Maks.	m	20 (1)		25 (1)							
	Sistemi E Pa karikueshme		m	20		30							
	Ngarkesa shtesë e ftohësit		kg/m	0,02 (për gjatësinë e tubacioneve mbi 20m)		0,02 (për gjatësinë e tubacioneve mbi 30 m)							
Dallimi në nivel	IU-OU Maks.		m	15									
Furnizimi me energji elektrike	Faza/Ampersuesit maksimal të siguresave (MFA)		A	1~/16	1~/20	1~/16	1~/20	1~/20	1~/25	1~/32			

Panele Diellore

Ngrohje & Ftohje

Hidraulike

Hidrosanitare

Aksesore të ndryshëm



Fan Coil - Daikin Mural FWT-GT

Daikin zgjidhje për çdo lloj ambienti

FWT-GT

Njësi e montuar në mur



FWT-GT



MERCA



SRC-HPA



WRC-HPC

Indoor unit		FWT-GT	02	03	04	05	06	
			2 Tuba					
Kapaciteti ftohës (kushtet standarde)	Kapaciteti total	I lartë	kW	2.40	2.67	3.27	4.49	5.21
		I mesëm	kW	2.20	2.23	2.79	4.02	4.32
		I ulët	kW	1.94	2.02	2.52	3.76	4.04
	Kapaciteti i ndjeshëm	I lartë	kW	1.82	1.99	2.60	3.38	4.03
		I mesëm	kW	1.73	1.69	2.21	3.00	3.52
		I ulët	kW	1.50	1.49	1.91	2.77	3.22
Kapaciteti i ngrohjes (kushtet standarde)	I lartë	kW	2.71	2.96	3.71	5.07	6.23	
	I mesëm	kW	2.41	2.62	3.29	4.51	5.38	
	I ulët	kW	2.06	2.25	2.75	4.03	4.83	
Fuqia hyrëse	I lartë	kW	0.031	0.032	0.042	0.053	0.072	
	I mesëm	kW		0.03	0.04	0.05	0.07	
	I ulët	kW		0.03		0.04	0.06	
FCEER				D		C	D	
FCCOP					C			
Dimensioni	Njësi	Lartësia x Gjerësia x Gjatësia	mm	288x800x206		310x1,070x224		
Pesha	Njësi		kg	9.00		14.00		
Shtrese e jashtme	Ngjyra			E bardhe				
Filtri i ajrit	Lloji			Saranet lahet				
Fan	Lloji			Ventilator me rrydhje të kryqëzuar				
	Sasi			1				
Shkalla e rrjedhjes së ajrit	I lartë	I lartë	m³/h	442	476	629	866	1,053
		I mesëm	m³/h	391	425	544	765	883
		I ulët	m³/h	340	374	442	663	782
Niveli total i fuqisë së zërit	I lartë	I lartë	dB(A)	45.0	48.0	55.0		59.0
		I mesëm	dB(A)	41.0	44.0	50.0	51.0	54.0
		I ulët	dB(A)	36.0	39.0	45.0	47.0	51.0
Niveli i presionit të zërit	I lartë	I lartë	dB(A)	34.0	35.0	42.0		46.0
		I mesëm	dB(A)	29.0	30.0	39.0	38.0	42.0
		I ulët	dB(A)		25.0	32.0	34.0	39.0
Lidhjet e tubacioneve	OD		mm	19				
Furnizimi me energji elektrike	Faza/Frekuenca/Tensioni		Hz/V	1N~/50/220-240				
Sistemet e kontrollit	Telekomandë infra të kuqe			WRC-HPA				
	Telekomanda me tela			MERCA / SRC-HPA				



Fan Coil -Daikin tokesore FWV-DAT

Daikin zgjidhje per cdo lloj ambienti

FWV-DAT

Njesi e montuar ne dysHEME



Panele Diellore

Ngrohje & Ftohje

Hidraulike

Hidrosanitare

Aksesore të ndryshëm

Indoor unit			FWV-DAT/DAF																			
			2-Tuba										4-Tuba									
			01	15	02	25	03	35	04	06	08	10	01	15	02	25	03	35	04	06	08	10
Kapaciteti ftohës (kushtet standarde)	Kapaciteti total	I larte	kW																			
		I mesem	kW																			
		I ulet	kW																			
	Kapaciteti i ndjeshëm	I larte	kW																			
		I mesem	kW																			
		I ulet	kW																			
Kapaciteti i ngrohjes (kushtet standarde)	I larte	kW																				
	I mesem	kW																				
	I ulet	kW																				
Fuqia hyrëse	I larte	kW																				
	I mesem	kW																				
	I ulet	kW																				
Dimensione	Njesi	LartësiaxGjerësiaxGjatësia	mm																			
Pesha	Njesi		kg																			
Shtrese e jashtme	Ngjyra		E bardhe - RAL9010																			
Filtri i ajrit	Lloi		Rrjetë polipropileni																			
Fan	Lloi		Centrifugal																			
	Sasia		1										2									
	Shkalla e rrjedhjes së ajrit	I larte	m³/h																			
		I mesem	m³/h																			
	I ulet	m³/h																				
Niveli total i fuqisë së zërit	I larte	dBA																				
	I mesem	dBA																				
	I ulet	dBA																				
Niveli i presionit të zërit	I larte	dBA																				
	I mesem	dBA																				
	I ulet	dBA																				
Ngrohës elektrik	Futja e energjisë (opsionale)		kW																			
Lidhjet e tubacioneve	OD		mm																			
Furnizimi me energji elektrike	Faza/Frekuenca/Tensioni		Hz/V																			
Sistemet e kontrollit	Telekomanda me tela		FWEC1A / FWEC2A / FWEC3A / FWEC5A / ECFWMB6 / FWTOUCH / FWEC2T / FWEC4T																			



Fan Coil - Daikin tokesore FWXV-ATV3

Daikin zgjidhje per cdo lloj ambienti

FWXV-ATV3

Njesi e montuar ne dysHEME

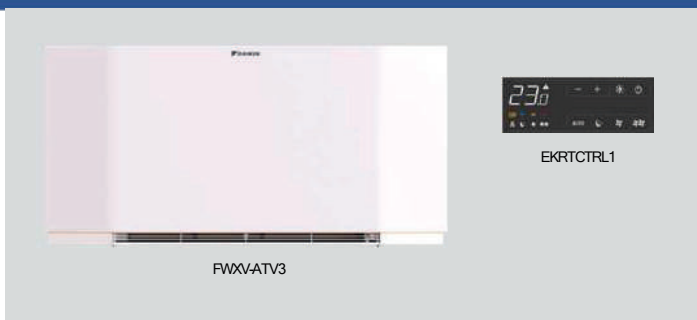

Njesi e brendshme				FWXV10ABTV3(R)	FWXV15ABTV3(R)	FWXV20ABTV3(R)
Kapaciteti ftohës at 7/12°C	Min.		kW	0.78	1.10	1.13
	Med.		kW	1.11	1.65	1.98
	Max.		kW	1.62	2.64	2.99
Kapaciteti i ndjeshëm ftohës at 7/12°C	Min.		kW	0.58	0.82	0.85
	Med.		kW	0.71	1.15	1.55
	Max.		kW	1.25	1.91	2.33
Kapaciteti i ngrohjes at 45/40°C	Min.		kW	0.87	1.12	1.11
	Med.		kW	1.27	1.83	2.32
	Max.		kW	1.96	2.86	3.50
Fuqja hyrëse	Min.		W	6	7	8
	Med.		W	10	13	15
	Max.		W	19	25	31
Shpejtësia e ventilatorit	Min.		RPM		720	
	Med.		RPM		1,220	
	Max.		RPM		1,700	
Shtresë e jashtme	Ngjyra			E bardhe, RAL 9003		
	Materiali			Fletë metalike		
Dimensionet	Njesi	Lartësi	mm		601	
		Gjerësi	mm	999	1,199	1,399
		Thellesi	mm		135	
	Njesi e paketuar	Lartësi	mm		690	
		Gjerësi	mm	1,230	1,430	1,630
		Thellesi	mm		210	
Pesha	Njesi		kg	20	23	26
	Njesi e paketuar		kg	21	24	27
Paketimi	Materiali			Kartoni		
	Pesha		kg		1	
Shkëmbyesi i nxehtësisë	Sasi				1	
		Vëllimi i brendshëm i spirales	l	080	1	1.46
		Presioni maksimal i funksionimit	bar		10	
Qarku i ujit	Diametri i lidhjeve të tubacioneve		inch		¾"mashkull	
	Materiali i tubacionit				Bakri	
	Ngrohja - Rënia e presionit të ujit at 45/40°C	Min.	kPa	7	9	8
		Med.	kPa	8	14	15
		Max.	kPa	11	23	22
	Ftohja - Rënia e presionit të ujit at 7/12°C	Min.	kPa	7	9	8
		Med.	kPa	8	14	15
		Max.	kPa	11	23	22
	Ngrohja - Shkalla e rrjedhjes së ujit at 45/40°C	Min.	kg/h	150	193	191
		Med.	kg/h	218	315	399
		Max.	kg/h	337	492	602
	Ftohja - Shkalla e rrjedhjes së ujit at 7/12°C	Min.	kg/h	134	189	194
		Med.	kg/h	191	284	341
		Max.	kg/h	279	454	514
Niveli i fuqisë së zërit	Presioni		bar		10	
	Min.	dBA	40	42	43	
	Med.	dBA	47	49	50	
	Max.	dBA	56	57	58	
Gama e funksionimit	Ngrohje	Ana e ujit	Min.	°C	30	
			Max.	°C	85	
	Ftohje	Ana e ujit	Min.	°C	5	
			Max.	°C	18	
	Instalim i brendshëm	Ambient	Min.	°CDB	0	
			Max.	°CDB	45	
Sistemet e kontrollit	Telekomandë infra të kuqe			no		
	Kontrolli në bord			yes		
Specifikimet elektrike				FWXV10ABTV3(R)	FWXV15ABTV3(R)	FWXV20ABTV3(R)
Furnizimi me energji elektrike	Faza			1		
	Frekuenca		Hz	50		
	Tensioni		V	230		
Konsumi i energjisë elektrike	Max.	W	19	25	31	
	Në gatishmëri	W	3	4	5	
	Aktuale	Rryma maksimale e funksionimit	A	0.15	0.21	0.27



Fan Coil - Daikin Inkaso FWXM-ATV3

Daikin zgjidhje per cdo lloj ambienti

FWXM-ATV3

Njesi e montuar inkaso



Indoor unit				FWXM10ATV3(R)	FWXM15ATV3(R)	FWXM20ATV3(R)	
Kapaciteti ftohës at 7/12°C	Min.			0.75	1.15	1.32	
	Med.			1.36	2.08	2.39	
	Max.			2.12	2.81	3.30	
Kapaciteti i ndjeshëm ftohës at 7/12°C	Min.			0.59	0.83	1.02	
	Med.			1.07	1.51	1.84	
	Max.			1.72	2.11	2.71	
Kapaciteti i ngrohjes at 45/40°C	Min.			0.82	1.20	1.47	
	Med.			1.53	2.16	2.57	
	Max.			2.21	3.02	3.81	
Power input	Min.			4	6	5	
	Med.			8	11	11	
	Max.			19	20	29	
Fanspeed	Min.				680		
	Med.				1,100		
	Max.				1,500		
Shtresë e jashtme	Materiali			Asnjë këllëf			
Dimensioni	Njesia	Lartesi	mm		576		
		Gjeresi	mm	725	925	1,125	
		Thellesi	mm		126		
	Njësi e paketuar	Lartesi	mm		690		
		Gjeresi	mm	830	1,030	1,230	
		Thellesi	mm		210		
Pesha	Njesi			12	15	18	
	Njësi e paketuar			13	16	19	
Paketim	Materiali			Carton			
	Pesha						
Shkëmbyesi i nxehtësisë	Sasi			1	1	1	
	Vëllimi i brendshëm i spirales			0.80	1.13	1.46	
		Presioni maksimal i funksionimit		bar		10	
				inch		¾" mashkull	
Qarku i ujit	Materiali i tubacionit			Bakri			
	Ngrohja - Rënia e presionit të ujit at 45/40°C	Min.	kPa	1.50	2.70	3	
		Med.	kPa	4.30	9.30	8.90	
		Max.	kPa	1.90	19.10	21.20	
	Ftohja - Rënia e presionit të ujit at 7/12°C	Min.	kPa	1.90	2.70	2.50	
		Med.	kPa	4.30	9.90	8.80	
		Max.	kPa	8.20	17.10	18	
	Ngrohja - Shkalla e rrjedhjes së ujit at 45/40°C	Min.	kg/h	141	206	253	
		Med.	kg/h	263	372	445	
		Max.	kg/h	380	519	655	
	Ftohja - Shkalla e rrjedhjes së ujit at 7/12°C	Min.	kg/h	129	198	227	
		Med.	kg/h	234	358	411	
Max.		kg/h	365	483	568		
Presioni		Ngrohje/Max.		bar	10		
Niveli i fuqisë së zërit	Min.			35	36	36	
	Med.			45	46	47	
	Max.			53	54	55	
Gama e funksionimit	Ngrohje	Ana e ujit	Min.	°C	30		
			Max.	°C	85		
	Ftohje	Ana e ujit	Min.	°C	5		
			Max.	°C	18		
	Instalim i brendshëm	Ambient	Min.	°CDB	0		
			Max.	°CDB	45		
Sistemet e kontrollit	Telekomandë infra të kuqe		no				
	Kontrolli në bord		no				
Specifikimet elektrike				FWXM10ATV3(R)	FWXM15ATV3(R)	FWXM20ATV3(R)	
Furnizimi me energji elektrike	Faza		1				
	Frekuenca		Hz				
	Tensioni		V				
Konsumi i energjisë elektrike	Max.			19	20	29	
	Në gatishmëri			3	4	5	
Aktuale	Rryma maksimale e funksionimit	A		0.16	0.18	0.26	

Panele Djellore

Ngrohje & Ftohje

Hidraulike

Hidrosanitare

Aksesore të ndryshëm



Fan Coil -Daikin e fshehur FWM-DAT

Daikin zgjidhje për çdo lloj ambienti

FWM-DAT

Njesi e fshehur në murë



Panele Dielllore

Ngrohje & Ftohje

Hidraulike

Hidrosanitare

Aksesore të ndryshëm

Indoor unit			FWV-DAT/DAF										01 15 02 25 03 35 04 06 08 10 01 15 02 25 03 35 04 06 08 10														
			2-Tuba										4-Tuba														
Kapaciteti ftohës (kushtet standarde)	Kapaciteti total	I lartë	kW	1.50	1.69	1.91	2.36	2.87	3.45	4.23	4.41	6.53	7.78	1.42	1.64	1.74	2.32	2.81	3.36	4.16	4.57	6.46	7.64				
		I mesëm	kW	1.21	1.48	1.66	1.99	2.34	2.585	3.21	3.59	5.14	6.07	1.11	1.44	1.52	1.96	2.29	2.54	3.17	3.74	5.10	5.99				
	I ulët	kW	1.02	1.24	1.34	1.57	1.73	1.94	2.47	2.95	3.88	4.00	0.97	1.22	1.24	1.55	1.70	1.92	2.44	3.06	3.84	3.96					
	Kapaciteti i ndjeshëm	I lartë	kW	1.16	1.25	1.37	1.82	2.05	2.69	3.05	3.55	4.73	5.72	1.10	1.22	1.41	1.79	2.01	2.61	2.99	3.47	4.68	5.61				
I mesëm		kW	0.94	1.10	1.20	1.53	1.66	1.99	2.39	2.85	3.70	4.46	0.87	1.07	1.18	1.50	1.62	1.96	2.36	2.80	3.67	4.40					
I ulët		kW	0.77	0.93	0.98	1.15	1.23	1.41	1.76	2.27	2.75	2.94	0.73	0.91	0.91	1.14	1.21	1.40	1.74	2.23	2.73	2.91					
Kapaciteti i ngrohjes (kushtet standarde)	I lartë	kW	1.82	1.84	2.15	2.70	2.94	4.05	4.24	4.98	6.49	8.37	1.66	1.76	2.53	2.68	4.20	3.82	4.64	6.97	7.35						
	I mesëm	kW	1.48	1.72	1.81	2.26	2.37	3.13	3.24	4.08	5.17	6.53	1.49	1.56	2.18	2.31	3.47	3.22	4.07	6.02	6.29						
	I ulët	kW	1.21	1.45	1.50	1.74	1.76	2.39	2.47	3.31	3.97	4.39	1.31	1.36	1.78	1.88	2.82	2.72	3.55	5.02	4.85						
Fuqia hyrëse	I lartë	kW	0.037	0.053	0.057	0.056	0.065	0.098	0.182	0.244	0.037	0.053	0.057	0.056	0.065	0.098	0.182	0.244									
	I mesëm	kW	0.03	0.04	0.05	0.06	0.07	0.13	0.17	0.03	0.04	0.05	0.06	0.07	0.13	0.17											
	I ulët	kW	0.02	0.03	0.02	0.03	0.04	0.05	0.09	0.11	0.02	0.03	0.02	0.03	0.04	0.05	0.09	0.11									
Dimensione	Njesi	Lartësi x Gjerësi x Gjatësia	mm	564x774x226			564x984x226			564x1,190x226			564x1,400x251			564x774x226			564x984x226			564x1,190x226			564x1,400x251		
Pesha	Njesi		kg	19.7	20.6	25.5	26.7	31.0	30.4	32.3	41.4	41.6	19.7	20.6	25.5	26.7	31.0	30.4	32.3	41.4	41.6						
Shtrese e jashtme	Ngjyra			E bardhe - RAL9010																							
Filtri i ajrit	Lloji			Rrjetë polipropileni																							
Fan	Lloji			Centrifugal																							
	Sasia			1					2					1					2								
	Shkalla e rrjedhjes së ajrit	I lartë	m³/h	319	344	442	640	706	785	1,011	1,393	307	330	327	432	431	628	690	763	998	1,362						
		I mesëm	m³/h	233	271	341	450	497	605	771	1,022	225	261	334	332	444	490	593	765	1,007							
I ulët	m³/h	178	211	241	320	361	470	570	642	174	205	238	237	316	356	460	565	636									
Niveli total i fuqisë së zërit	I lartë	dB(A)	47.0	49.0	50.0	48.0	52.0	53.0	56.0	61.0	67.0	45.0	49.0	50.0	48.0	47.0	53.0	56.0	58.0	60.0	66.0						
	I mesëm	dB(A)	42.0	44.0	43.0	42.0	43.0	49.0	54.0	60.0	39.0	44.0	43.0	41.0	45.0	46.0	53.0	54.0	58.0								
	I ulët	dB(A)	37.0	38.0	40.0	35.0	36.0	35.0	43.0	47.0	49.0	33.0	40.0	38.0	34.0	33.0	36.0	39.0	48.0	46.0	48.0						
Niveli i presionit të zërit	I lartë	dB(A)	42.0	44.0	45.0	43.0	47.0	48.0	51.0	56.0	62.0	40.0	44.0	45.0	43.0	42.0	46.0	51.0	54.0	55.0	61.0						
	I mesëm	dB(A)	37.0	39.0	38.0	37.0	38.0	44.0	49.0	55.0	34.0	39.0	38.0	36.0	38.0	41.0	48.0	49.0	53.0								
	I ulët	dB(A)	32.0	33.0	35.0	30.0	31.0	30.0	38.0	42.0	44.0	28.0	33.0	29.0	28.0	29.0	32.0	43.0	41.0	43.0							
Ngrohës elektrik	Futja e energjisë (opsionale)	kW	1.0	1.5	1.6	2.0	3.0	1.0	1.5	1.6	2.0	3.0															
Lidhjet e tubacioneve	OD	mm	16																								
Furnizimi me energji elektrike	Faza/Frekuenca/Tensioni	Hz/V	1~/50/230																								
Sistemet e kontrollit	Telekomanda me tela		FWEC1A / FWEC2A / FWEC3A / FWEC5A / ECFWMB6 / FWT TOUCH / FWEC2T / FWEC4T																								



Chiller – Daikin EWYA-DV3P

Daikin zgjidhje per cdo lloj ambienti

EWYA – DV3P

Karakteristikat dhe funksionet

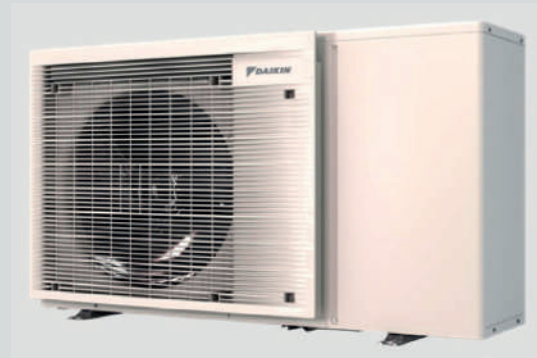

EWYA-DV3P

Ngrohje & Ftohje		EWYA-D		004DV3P	006DV3P	008DV3P
Ngrohja e hapësirës	Gjeneral	SCOP		4.54	4.52	4.61
		Efikasiteti i ngrohjes sezonale të hapësirës, klasës			A+++	
Kapaciteti ftohës	Nom.	kW		4.86 (1) / 4.52 (2)	5.83 (1) / 5.09 (2)	6.18 (1) / 5.44 (2)
Heating capacity	Nom.	kW		4.30 (1) / 4.60 (2)	6.00 (1) / 5.90 (2)	7.50 (1) / 7.80 (2)
Fuqia hyrëse	Ftohje	Nom.	kW	0.820 (1) / 1.36 (2)	1.08 (1) / 1.55 (2)	1.19 (1) / 1.73 (2)
	Ngrohje	Nom.	kW	0.840 (1) / 1.26 (2)	1.24 (1) / 1.69 (2)	1.63 (1) / 2.23 (2)
EER				5.91 (1) / 3.32 (2)	5.40 (1) / 3.28 (2)	5.19 (1) / 3.14 (2)
COP				5.10 (1) / 3.65 (2)	4.85 (1) / 3.50 (2)	4.60 (1) / 3.50 (2)
Dimensioni	Njesi	Lartësia	mm	770		
		Gjerësia	mm	1,250		
		Thellesi	mm	362		
Pesha	Njesia	kg		88.0		
Shkëmbyesi i nxehtësisë së ujit	Lloji	Shkëmbyesi i nxehtësisë së pllakave				
	Vëllimi i ujit	l				
Kompresor	Lloji	Kompresor rrotullues i mbyllur hermetikisht				
	sasi	1				
Fan	Lloji	Ventilator i helikës				
	sasi	1				
Niveli i fuqisë së zërit	Ftohje	Nom.	dB(A)	61.0 (1)	62.0 (1)	
	Ngrohje	Nom.	dB(A)	58.0 (1)	60.0 (1)	62.0 (1)
Niveli i presionit të zërit	Ftohje	Nom.	dB(A)	48.0 (1)	49.0 (1)	50.0 (1)
	Ngrohje	Nom.	dB(A)	44.0 (1)	47.0 (1)	49.0 (1)
Gama e funksionimit	Ana ajrore	Ftohje	Min.~Max.	°CDB		
		Ngrohje	Min.~Max.	°CDB		
	Ana e ujit	Ftohje	Min.~Max.	°CDB		
		Ngrohje	Min.~Max.	°CDB		
Ftohës	Lloji/GWP	R-32/675.0				
	Ngarkimi	kg		1.35		
Furnizimi me energji elektrike	Faza/Frekuenca/Tensioni	Hz/V		1~/50/230+/-10%		

Panele Diellore

Ngrohje & Ftohje

Hidraulike

Hidrosanitare

Aksesore të ndryshëm



Chiller – Daikin EWYA-DV3P

Daikin zgjidhje për çdo lloj ambienti

EWYA – DV3P

Karakteristikat dhe funksionet



EWYA-DV3P

Ngrohje & Ftohje		EWYA-D		009DV3P	011DV3P	014DV3P	016DV3P	
Ftohja e hapësirës	Pdc	kW		9.35	11.6	12.8	14.0	
	η _{s,c}	%		222	229	226	221	
SEER				5.62 (6)	5.79 (6)	5.71 (6)	5.59 (6)	
Ngrohja e hapësirës	Gjeneral	SCOP		4.82	4.73	4.70	4.69	
		Efikasiteti i ngrohjes sezonale të hapësirës, klasës		A+++				
Kapaciteti ftohës	Nom.	kW		9.35 (2) / 9.10 (3)	11.6 (2) / 11.5 (3)	12.8 (2) / 12.7 (3)	14.0 (2) / 15.3 (3)	
Kapaciteti i ngrohjes	Nom.	kW		9.37 (4) / 9.00 (5)	10.6 (4) / 9.82 (5)	12.0 (4) / 12.5 (5)	16.0 (4) / 16.0 (5)	
Fuqia hyrëse	Ftohja	Nom.	kW		2.79 (2) / 1.71 (3)	3.56 (2) / 2.17 (3)	4.06 (2) / 2.51 (3)	4.58 (2) / 3.24 (3)
	Ngrohje	Nom.	kW		1.91 (4) / 2.43 (5)	2.18 (4) / 2.68 (5)	2.46 (4) / 3.42 (5)	3.53 (4) / 4.56 (5)
Kontrolli i kapacitetit		Metoda		E ndryshueshme (inverter)				
EER				3.35 (2) / 5.34 (3)	3.26 (2) / 5.31 (3)	3.16 (2) / 5.04 (3)	3.06 (2) / 4.74 (3)	
COP				4.91 (4) / 3.71 (5)	4.83 (4) / 3.66 (5)	4.87 (4) / 3.64 (5)	4.53 (4) / 3.51 (5)	
Dimensioni	Njesia	Lartësia	mm		870			
		Gjerësia	mm		1,380			
		Thellesi	mm		460			
Pesha	Njesia	kg		147				
Shkëmbyesi i nxehtësisë së ujit	Lloji	Shkëmbyesi i nxehtësisë së pllakave						
	Vëllimi i ujit	l		2				
Lloji i shkëmbyesit të nxehtësisë së ajrit		Tipi fin dhe tub me efikasitet të lartë me nënftohës integral						
Kompresor	Lloji	Kompresor inverter lëkundje i mbyllur hermetikisht						
	sasi	1						
Fan	Lloji	Ventilator i helikës						
	sasi	1						
	Shkalla e rrjedhjes së ajrit	Ftohja	Nom.	m ³ /min	63	70	85	
		Ngrohje	Nom.	m ³ /min	48.0	55.8	70.4	85.0
Niveli i fuqisë së zërit	Ftohja	Nom.	dBA		65.5	67.0	69.0	
Niveli i presionit të zërit	Ftohja	Nom.	dBA		44.0	47.7	50.8	51.0
Gama e funksionimit	Ana ajrore	Ftohja	Min.~Max.	°CDB		10 ~ 43		
		Ngrohje	Min.~Max.	°CDB		-25 ~ 25		
	Ana e ujit	Ftohja	Min.~Max.	°CDB		5 ~ 22		
		Ngrohje	Min.~Max.	°CDB		9 (1) ~ 6(1)		
Ftohës	Lloji/GWP	R-32/675.0						
	Kontrolli	Valvula e zgjerimit elektronik						
	Qarqet sasi	1						
Ngarkesa e ftohësit	Për qark	kg		3.80				
		TCO _{2eq}		2.6				
Njësia	Rryma maksimale e funksionimit	A		30.8				
Furnizimi me energji elektrike	Faza/Frekuenca/Tensioni	Hz/V		1~/50/230				



Chiller – Daikin EWYA-DW1P

Daikin zgjidhje per cdo lloj ambienti

EWYA – DW1P

Karakteristikat dhe funksionet



EWYA-DW1P

Ngrohje & Ftohje		EWYA-D		009DW1P	011DW1P	014DW1P	016DV3P	
Ftohja e hapësirës	Një gjendje 35°C Pdc		kW	9.35	11.6	12.8	14.0	
	η _{s,c}		%	222	229	226	221	
SEER				5.62	5.79	5.71	5.59	
Ngrohja e hapësirës	Gjeneral	SCOP		4.82	4.73	4.70	4.69	
		Efikasiteti i ngrohjes sezonale të hapësirës, klasës		A+++				
Kapaciteti ftohës	Nom.	kW		9.35 (1) / 9.10 (2)	11.6 (1) / 11.5 (2)	12.8 (1) / 12.7 (2)	14.0 (1) / 15.3 (2)	
Kapaciteti i ngrohjes	Nom.	kW		9.37 (3) / 9.00 (4)	10.6 (3) / 9.82 (4)	12.0 (3) / 12.5 (4)	16.0 (3) / 16.0 (4)	
Fuqia hyrëse	Ftohja	Nom.	kW		2.79 (1) / 1.71 (2)	3.56 (1) / 2.17 (2)	4.06 (1) / 2.51 (2)	4.58 (1) / 3.24 (2)
	Ngrohje	Nom.	kW		1.91 (3) / 2.43 (4)	2.18 (3) / 2.68 (4)	2.46 (3) / 3.42 (4)	3.53 (3) / 4.56 (4)
Kontrolli i kapacitetit	Metoda		E ndryshueshme (inverter)					
EER				3.35 (1) / 5.34 (2)	3.26 (1) / 5.31 (2)	3.16 (1) / 5.04 (2)	3.06 (1) / 4.74 (2)	
COP				4.91 (3) / 3.71 (4)	4.83 (3) / 3.66 (4)	4.87 (3) / 3.64 (4)	4.53 (3) / 3.51 (4)	
Dimensioni	Njesia	Lartësia	mm		870			
		Gjerësia	mm		1,380			
		Thellesi	mm		460			
Pesha	Njesia	kg		147				
Shkëmbyesi i nxehtësisë së ujit	Lloji	Shkëmbyesi i nxehtësisë së pllakave						
	Vëllimi i ujit	l		2				
Lloji i shkëmbyesit të nxehtësisë së ajrit		Tipi fin dhe tub me efikasitet të lartë me nënftohës integral						
Kompresor	Lloji	Kompresor inverter lëkundje i mbyllur hermetikisht						
	sasi	1						
Fan	Lloji	Ventilator i helikës						
	sasi	1						
	Shkalla e rrjedhjes së ajrit	Ftohja	Nom.	m ³ /min		63	70	85
	Ngrohje	Nom.	m ³ /min		48.0	55.8	70.4	85.0
Niveli i fuqisë së zërit	Ftohja	Nom.	dBA		65.5	67.0	69.0	
Niveli i presionit të zërit	Ftohja	Nom.	dBA		44.0	47.7	50.8	51.0
Gama e funksionimit	Ana ajrore	Ftohja	Min.~Max.	°CDB		10 ~ 43		
		Ngrohje	Min.~Max.	°CDB		-25 ~ 25		
	Ana e ujit	Ftohja	Min.~Max.	°CDB		5 ~ 22		
		Ngrohje	Min.~Max.	°CDB		9 ~ 60		
Ftohës	Lloji/GWP	R-32/675.0						
	Kontrolli	Valvula e zgjerimit elektronik						
	Qarqet sasi	1						
Ngarkesa e ftohësit	Për qark	kg		3.80				
	Për qark	TCO2Eq		2.6				
Njësia	Rryma maksimale e funksionimit	A		14.0				
Furnizimi me energji elektrike	Faza/Frekuenca/Tensioni	Hz/V		3~/50/400				



Chiller – Daikin EWYT-CZP

Daikin zgjidhje per cdo lloj ambienti

EWYT – CZP

Karakteristikat dhe funksionet



EWYT-CZP

Ngrohje & Ftohje			EWYT	016CZP-A1	021CZP-A1	025CZP-A1	032CZP-A1	040CZP-A1	040CZP-A2	050CZP-A2	064CZP-A2	090CZP-A2	
Ftohja e hapësirës	Një gjendje 35°C Pdc		kW	16.0	21.0	25.7	32.6	39.8	41.6	51.0	64.3	88.6	
	ηs,c		%	209	213		225	211	228	216	211	204	
SEER				5.30	5.41		5.70	5.36	5.76	5.48	5.34	5.18	
Ngrohja e hapësirës	Gjeneral	SCOP		4.03	4.19		4.18		4.19	4.12	4.01	4.04	
		Efikasiteti i ngrohjes sezonale të hapësirës, klasës		A++									
Kapaciteti ftohës	Nom.		kW	16.1	21.1	25.9	32.7	39.9	41.7	51.1	64.4	88.8	
Kapaciteti i ngrohjes	Nom.		kW	15.6	19.9	24.6	32.1	39.0	40.0	49.5	61.4	85.3	
Fuqia hyrëse	Ftohja	Nom.	kW	5.45	6.56	8.48	10.3	13.3	13.2	16.9	21.9	31.1	
	Ngrohje	Nom.	kW	4.63	5.81	7.42	9.32	11.7	11.8	15.3	19.2	27.3	
Kontrolli i kapacitetit	Metoda		I kontrolluar me inverter										
	Kapaciteti minimal		%	18	14	12	19	15	14	12	15	14	
EER				2.96	3.22	3.05	3.18	3.00	3.17	3.03	2.95	2.85	
COP				3.37	3.43	3.31	3.44	3.33	3.38	3.23	3.20	3.13	
IPLV				5.83	6.29	6.05	6.25	5.87	6.37	5.92	5.88	5.61	
Dimensioni	Njësia	Lartësia	mm	1,878									
		Gjerësia	mm	1,152		1,752		2,306		2,906		3,506	
		Thellesi	mm	802				814					
Pesha	Njësia		kg	261	286		393	392	546		644	749	
	Pesha e operacionit		kg	262	288		396	395	551		650	757	
Shkëmbyesi i nxehtësisë së ujit	Lloji		Shkëmbyes nxehtësie me pllakë tulli										
	Vëllimi i ujit		l	1		2		5		8			
	Shkalla e rrjedhjes së ujit	Ftohja	Nom.	l/s	0.8	1.0	1.2	1.6	1.9	2.0	2.4	3.1	4.2
		Ngrohje	Nom.	l/s	0.8	1.0	1.2	1.5	1.9	2.4	3.0	4.1	
	Rënia e presionit të ujit	Ftohja	Nom.	kPa	20	11	16	19	28	10	14	22	20
Ngrohje		Nom.	kPa	19.6	10.6	15.4	19.1	27.1	9.4	13.8	20.4	19.1	
Shkëmbyesi i nxehtësisë së ajrit	Lloji		Lloji i fijeve dhe tubave me efikasitet të lartë - Alumini prej bakri										
Kompresor	Lloji		Kompresori me lëvizje										
	sasi		1		2		3		5				
Fan	Lloji		Axial										
	sasi		1		2		3		5				
	Shpejtësia		rpm	800	900	700	900	700	900	800	900		
Niveli i fuqisë së zërit	Ftohja	Nom.	dBA	76.0	78.0	79.0	80.0	81.0	83.0	85.0			
Niveli i presionit të zërit	Ftohja	Nom.	dBA	59.7	61.7	62.2	63.2	62.8	63.8	65.4	67.0		
Ftohës	Lloji/GWP		R-32/675										
	Ngarkimi		kg	3.00	5.50	7.00	8.00	12.0	13.0	16.0			
	Qarqet sasi			1		2							
Lidhjet e tubacioneve	Uji i avulluesit hyrje/dalje (OD)		1"1/4		2"								







VRV-Daikin Murale FXAA-A

Daikin zgjidhje për ambientin tuaj

FXAA-A

Njesi VRV e montuar ne mure

Karakteristikat dhe funksionet

Efikasitet	Funksioni
	
Kontroll dhe planifikim	Funksione të tjera
 Opsional	



FXAA-A



BRC1H52W BRP069C51

Indoor Unit			FXAA	15A	20A	25A	32A	40A	50A	63A	
Kapaciteti ftohes	Me shpejtesi te larte ventilatori	kW	1.7	2.2	2.8	3.6	4.5	5.6	7.1		
Kapaciteti ngrohes	Me shpejtesi te larte ventilatori	kW	1.9	2.5	3.2	4.0	5.0	6.3	8.0		
Fuqia hyrse – 50Hz	Ftohje	Me shpejtesi te larte ventilatori	kW	0.017	0.019	0.028	0.030	0.025	0.033	0.050	
	Ngrohje	Me shpejtesi te larte ventilatori	kW	0.025	0.029	0.034	0.034	0.030	0.039	0.060	
Dimensioni	Njesi	LartesisGjeresixThellesi	mm	290x795x266					290x1,050x269		
Pesha	Njesi		kg	12					15		
Fan	Ftohje me nivel te larte/mesem/ shpejtesi e ulet ventilatori	m ³ /min	7.1/6.8/6.5	7.9/7.2/6.5	8.3/7.4/6.5	9.4/8.0/6.5	12.2/11.0/9.8	14.2/12.6/10.9	18.2/15.5/12.9		
		Ngrohje me nivel te larte/mesem/ shpejtesi e ulet ventilatori	m ³ /min	7.8/6.8/6.5	8.6/7.5/6.5	9.0/7.7/6.5	9.9/11.0/9.8	12.2/11.0/9.8	15.2/13.7/12.1	18.7/16.4/14.1	
Filtri ajrit	Lloji			I lëvizshëm/lahet							
Niveli i fuqisë së zërit	Ftohje	Me shpejtesi te larte ventilatori	dB(A)	51.0	52.0	53.0	55.0		58.0	63.0	
Niveli i presionit të zërit	Ftohje	Me shpejtësi të lartë/mesatare/të ulët të ventilatorit	dB(A)	32.0/30.5/28.5	33.0/31.0/28.5	35.0/32.0/28.5	37.5/33.0/28.5	37.0/35.5/33.5	41.0/38.5/35.5	46.5/42.5/38.5	
	Ngrohje	Me shpejtësi të lartë/mesatare/të ulët të ventilatorit	dB(A)	33.0/31.0/28.5	34.0/31.5/28.5	36.0/32.5/28.5	38.5/33.5/28.5	38.0/36.0/33.5	42.0/39.0/35.5	47.0/43.0/38.5	
Ftohes	Lloj/GWP			R-32/675.0							
Lidhjet e tubacioneve	E lengshme OD	mm	6.35								
	Gaz	OD	mm	9.52							
	Kullo			VP13 (I.D. 15/O.D. 18)					12.70		
Furnizimi me energji elektrike	Faza/Frekuenca/Tensioni	Hz/V	1~/50/220-240								
Aktuale – 50Hz	Amplifikatorët maksimalë të siguresave (MFA)	A	6								
Sistemet e kontrollit	Telekomandë infra të kuqe		BRC7EA630 (1)								
	Telekomanda me tela		BRC1H52W/S/K								

Panele Dielllore

Ngrohje & Ftohje

Hidraulike

Hidrosanitare

Aksesore të ndryshëm



VRV-Daikin Murale FXAQ-A

Daikin zgjidhje per ambientin tuaj

FXAQ-A

Njesi VRV e montuar ne mure



FXAQ-A



BRC1H52W

BRC7EA628

Karakteristikat dhe funksionet



Indoor Unit		FXAQ	15A	20A	25A	32A	40A	50A	63A
Kapaciteti ftohes	Me shpejtesi te larte ventilatori	kW	1.7	2.2	2.8	3.6	4.5	5.6	7.1
Kapaciteti ngrohes	Me shpejtesi te larte ventilatori	kW	1.9	2.5	3.2	4.0	5.0	6.3	8.0
Fuqia hyrse – 50Hz	Ftohje Me shpejtesi te larte ventilatori	kW	0.02		0.03		0.02	0.03	0.05
	Ngrohje Me shpejtesi te larte ventilatori	kW		0.03		0.04	0.02	0.04	0.06
Dimensioni	Njesi LartesisGjeresixThellesi	mm	290x795x266			290x1,050x269			
Pesha	Njesi	kg	12			15			
Fan Shkalla e rrjedhes e ajrit	Ftohje me nivel te larte/mesem/ shpejtesi e ulet ventilatori	m ³ /min	8.4/7.0	9.1/7.0	9.4/7.0	9.8/7.0	12.2/9.7	14.4/11.5	18.3/13.5
Filtri ajrit	Lloji		I lëvizshëm/lahet						
Niveli i fuqisë së zërit	Ftohje Me shpejtesi te larte ventilatori	dBa	51.0	52.0	53.0	55.0		58.0	63.0
Niveli i presionit të zërit	Ftohje Me shpejtësi të lartë/mesatare/të ulët të ventilatorit	dBa	32.0/28.5	33.0/28.5	35.0/28.5	37.5/28.5	37.0/33.5	41.0/35.5	46.5/38.5
	Ngrohje Me shpejtësi të lartë/mesatare/të ulët të ventilatorit	dBa	33.0/28.5	34.0/28.5	36.0/28.5	38.5/28.5	38.0/33.5	42.0/35.5	47.0/38.5
Ftohes	Lloji/GWP		R-410A/2,087.5						
Lidhjet e tubacioneve	E lengshme OD	mm	6.35		9.52				
	Gaz OD	mm	12.7		15.9				
	Kullo		VP13 (I.D. 15/O.D. 18)						
Furnizimi me energji elektrike	Faza/Frekuenca/Tensioni	Hz/V	1~/50 /220-240						
Aktuale – 50Hz	Amplifikatorët maksimalë të siguresave (MFA)	A	16						
Sistemet e kontrollit	Telekomandë infra të kuqe		BRC7EA628 / BRC7EA629						
	Telekomanda me tela		BRC1H52W/S/K / BRC1E53A / BRC1E53B / BRC153C / BRC1D52						



VRV-Daikin Tokesore FXLQ-P

Daikin zgjidhje per ambientin tuaj

FXLQ-P

Njesi VRV e montuar ne dysheme

Karakteristikat dhe funksionet



Panele Diellore

Ngrohje & Ftohje

Hidraulike

Hidrosanitare

Aksesore të ndryshëm

Indoor Unit		FXLQ	20P	25P	32P	40P	50P	63P	
Kapaciteti ftohes	Me shpejtesi te larte ventilatori	kW	2.2	2.8	3.6	4.5	5.6	7.1	
Kapaciteti ngrohes	Me shpejtesi te larte ventilatori	kW	2.5	3.2	4.0	5.0	6.3	8.0	
Fuqia hyrse – 50Hz	Ftohje	Me shpejtesi te larte ventilatori	kW		0.05	0.09	0.11		
	Ngrohje	Me shpejtesi te larte ventilatori	kW		0.05	0.09	0.11		
Dimensioni	Njesi	LartesisGjeresixThellesi	mm		600x1,000x232	600x1,140x232	600x1,420x232		
Pesha	Njesi		kg		27	32	38		
Fan	Shkalla e rrjedhes e ajrit	Ftohje me nivel te larte/mesem/ shpejtesi e ulet ventilatori	m ³ /min		7/6.0	8/6.0	11/8.5	14/11.0	16/12.0
Filtri ajrit	Loji		Rrjetë rrëshirë						
Niveli i fuqisë së zërit	Ftohje	Me shpejtesi te larte ventilatori	dBa		54	57	58	59	
Niveli i presionit të zërit	Ftohje	Me shpejtësi të lartë/mesatare/të ulët të ventilatorit	dBa		35/32	38/33	39/34	40/35	
	Ngrohje	Me shpejtësi të lartë/mesatare/të ulët të ventilatorit	dBa		35/32	38/33	39/34	40/35	
Ftohes	Lloi/GWP		R-410A/2,087.5						
Lidhjet e tubacioneve	E lengshme OD	mm	6.35						
	Gaz OD	mm	12.7						
	Kullo		O.D.21 (klour vinil)						
Furnizimi me energji elektrike	Faza/Frekuenca/Tensioni	Hz/V	1~/50/60/220-240/220						
Aktuale – 50Hz	Amplifikatorët maksimalë të siguresave (MFA)	A	15						
Sistemet e kontrollit	Telekomandë infra të kuqe		BRC4C65						
	Telekomanda me tela		BRC1H52W/S/K / BRC1E53A / BRC1E53B / BRC1E53C / BRC1D52						



VRV-Daikin Tavanore FXHA-A

Daikin zgjidhje per ambientin tuaj

FXHA-A

Njesi VRV e varur ne tavan

Karakteristikat dhe funksionet

Efikasitet



FXHA-A



BRC1H52W BRP069C51

32A		FXHA-A		32A	50A	63A	100A
Kapaciteti ftohes	Me shpejtësi të lartë të ventilatorit	kW		3.6	6.5	7.1	11.2
	Nom.	kW		3.6	6.5	7.1	11.2
Kapaciteti ngrohes	Me shpejtësi të lartë të ventilatorit	kW		4.0	6.3	8.0	12.5
	Nom.	kW		4.0	6.3	8.0	12.5
Fuqia hyrse – 50Hz	Ftohje	Me shpejtësi te larte ventilatori	KW	0.033	0.037	0.051	0.086
	Ngrohje	Me shpejtësi te larte ventilatori	KW	0.033	0.037	0.051	0.086
Dimensioni	Njesi	LartesixGjeresixThellesi	mm	235x960x690	235x1,270x690	235x1,590x690	235x1,590x690
Pesha	Njesi		kg	28	36	43	43
Shtrese e jashtme	Material	Rrëshirë, llamarina					
Fan	Ftohje me nivel te larte/mesem/ ulet ventilatori	m ³ /min shpejtësi e ulet ventilatori		12.5/11.0/10.0	16.0/14.0/12.5	17.5/15.0/13.0	27.0/22.0/19.0
	Ngrohje me nivel te larte/mesem/ ulet ventilatori	m ³ /min shpejtësi e ulet ventilatori		12.5/11.0/10.0	16.0/14.0/12.5	17.5/15.0/13.0	27.0/22.0/19.0
Filtri ajrit	Lloji	Rrjetë rrëshirë					
Niveli i fuqisë së zërit	Ftohje	dB(A)		54.0/52.0/49.0	54.0/52.0/50.0	55.0/53.0/52.0	62.0/55.0/52.0
	Ngrohje	dB(A)		36.0/34.0/31.0	36.5/34.5/33.0	37.0/35.0/34.0	44.0/37.0/34.0
	Ngrohje	dB(A)		36.0/34.0/31.0	36.5/34.5/33.0	37.0/35.0/34.0	44.0/37.0/34.0
Ftohes	Lloji/GWP	R-32/675					
Lidhjet e tubacioneve të lëngshm	OD	mm			6.4		9.5
	Gaz	OD	mm	9.5		12.7	15.9
	Kulloj	VP20					
Furnizimi me energji elektrike	Faza/Frekuenca/Tensioni	Hz/V		1~/50/60/220-240/220			
Aktuale – 50Hz	Siguresa maksimale amps (MFA)	A		6			
Sistemet e kontrollit	Telekomandë infra të kuqe	BRC7GA53-9					
	Telekomanda me tela	BRC1H52W/S/K					



VRV-Daikin Tavanore FXHQ-A

Daikin zgjidhje për ambientin tuaj

FXHQ-A

Njësi VRV e varur në tavan



FXHQ-A



BRC1H52W BRC7EA628

Panele Diellore

Ngrohje & Ftohje

Hidraulike

Hidrosanitare

Aksesore të ndryshëm

Indoor Unit		FXHQ	32A	63A	100A
Kapaciteti ftohes	Me shpejtesi te larte ventilatori	kW	3.6	7.1	11.2
Kapaciteti ngrohes	Me shpejtesi te larte ventilatori	kW	4.0	8.0	12.5
Fuqia hyrse – 50Hz	Ftohje Me shpejtesi te larte ventilatori	kW	0.107	0.111	0.237
	Ngrohje Me shpejtesi te larte ventilatori	kW	0.107	0.111	0.237
Dimensioni	Njesi LartesixGjeresixThellesi	mm	235x960x690	235x1,270x690	235x1,590x690
Pesha	Njesi	kg	24	33	39
Fan	Ftohje me nivel te larte/mesem/ ventilatori	m ³ /min shpejtesi e ulet	14.0/12.0/10.0	20.0/17.0/14.0	29.5/24.0/19.0
	Ngrohje me nivel te larte/mesem/ ventilatori	m ³ /min shpejtesi e ulet	14.0/12.0/10.0	20.0/17.0/14.0	29.5/24.0/19.0
Filtri ajrit	Lloji		Rrjetë rrëshirë me rezistencë ndaj mykut		
Niveli i fuqisë së zërit	Ftohje Me shpejtesi te larte ventilatori	dBA	54/52/49	55/53/52	62/55/52
Niveli i presionit të zërit	Ftohje Me shpejtësi të lartë/mesatare/të ulët ventilatorit	dBA	36.0/34.0/31.0	37.0/35.0/34.0	44.0/37.0/34.0
	Ngrohje Me shpejtësi të lartë/mesatare/të ulët të ventilatorit	dBA	36.0/34.0/31.0	37.0/35.0/34.0	44.0/37.0/34.0
Ftohes	Lloj/GWP		R-41A/2,087.5		
Lidhjet e tubacioneve	E lengshme OD	mm	6.4	9.5	
	Gaz OD	mm	12.7	15.9	
	Kullo		VP20 (I.D. 20/O.D. 26)		
Furnizimi me energji elektrike	Faza/Frekuenca/Tensioni	Hz/V	1~/50 /60/220-240/220		
Aktuale – 50Hz	Amplifikatorët maksimalë të siguresave (MFA)	A	16		
Sistemet e kontrollit	Telekomandë infra të kuqe		BRC7GA53 / BRC7GA56		
	Telekomanda me tela		BRC1H52W/S/K / BRC1E53A / BRC1E53B / BRC1E53C / BRC1D52		



VRV-Daikin Tavanore FXUA-A

Daikin zgjidhje per ambientin tuaj

FXUA-A

Njesi VRV e varur ne tavan

Karakteristikat dhe funksionet



Indoor Unit		FXUA	50A	71A	100A
Kapaciteti ftohës	Me shpejtësi të lartë të ventilatorit	kW	5.6	8.0	11.2
	Nom.	kW	5.6	8.0	11.2
Kapaciteti i ngrohjes	Me shpejtësi të lartë të ventilatorit	kW	6.3	9.0	12.5
	Nom.	kW	6.3	9.0	12.5
Fuqia hyrëse – 50Hz	Ftohje Me shpejtësi të lartë të ventilatorit	kW	0.029	0.055	0.117
	Ngrohje Me shpejtësi të lartë të ventilatorit	kW	0.029	0.055	0.117
Dimensione	Njësia LartësiaxGjerësiaxThellësia	mm		198x950x950	
Pesha	Njësia	kg		27	28
Shtresë e jashtme	Material			Rrëshirë	
Fan	Rrjedha e ajrit Ftohje me shpejtësi të lartë / mesatare m ³ /min – 50Hz/ shpejtësi të ulët të ventilatorit		17.0/14.5/13.0	22.5/18.5/16.0	31.0/25.5/21.0
	Ngrohje me m ³ /min të lartë / mesatare/ shpejtësi e ulët e ventilatorit		17.0/14.5/13.0	22.5/18.5/16.0	31.0/25.5/21.0
Filtri i ajrit	Lloji			Rrjetë rrëshirë	
Niveli i fuqisë së zërit	Ftohje	dB(A)	55.0/53.0/51.0	58.0/56.0/54.0	65.0/62.0/58.0
Niveli i presionit të zërit	Ftohje	dB(A)	37.0/35.0//33.0	40.0/38.0/36.0	47.0/44.0/40.0
	Ngrohje	dB(A)	37.0/35.0//33.0	40.0/38.0/36.0	47.0/44.0/40.0
Ftohës	Lloji/GWP			R-32/675	
Lidhjet e tubacioneve të lëngshme	OD	mm		6.4	9.5
	Gaz OD	mm		12.7	15.9
	Kullojeni			VP20	
Furnizimi me energji elektrike	Faza/Frekuenca/Tensioni	Hz/V		1~/50/60/220-240/220	
Rryma - 50Hz	Amplifikatorët maksimalë të siguresave (MFA)	A		6	
Sistemet e kontrollit	Telekomandë infra të kuqe			BRC7CB58/ BRC7CB59	
	Telekomanda me tela			BRC1H52W/S/K	



VRV-Daikin Tavanore FXUQ-A

Daikin zgjidhje për ambientin tuaj

FXUQ-A

Njesi VRV e varur ne tavan

Karakteristikat dhe funksionet



Panele Diellore

Ngrohje & Ftohje

Hidraulike

Hidrosanitare

Aksesore të ndryshëm

Njësia e brendshme		FXUQ	71A	100A	
Kapaciteti ftohës	Kapaciteti total	Me shpejtësi të lartë të ventilatorit	kW	8.0	11.2
Kapaciteti i ngrohjes	Kapaciteti total	Me shpejtësi të lartë të ventilatorit	kW	9.0	12.5
Fuqia hyrëse – 50Hz	Ftohje	Me shpejtësi të lartë të ventilatorit	kW	0.090	0.200
	Ngrohje	Me shpejtësi të lartë të ventilatorit	kW	0.073	0.179
Dimensione	Njesi	HeightxWidthxDepth	mm	198x950x950	
Pesha	Njesi		kg	26	27
Shtresë e jashtme	Material	Rrëshirë			
Fan	Shkalla e rrjedhjes së ajrit-50Hz	Ftohje Me shpejtësi të ulët të ventilatorit të lartë/mesatar/ m³/min		22.5/19.5/16.0	31.0/26.0/21.0
		Ngrohje Me shpejtësi të ulët të ventilatorit të lartë/mesatar/ m³/min		22.5/19.5/16.0	31.0/26.0/21.0
Filtri i ajrit	Lloji	Rrjetë rrëshirë me rezistencë ndaj mykut			
Niveli i fuqisë së zërit	Ftohje	Me shpejtësi të lartë/mesatare/të ulët të ventilatorit	dBa	58/56/54	65/62/58
Niveli i presionit të zërit	Ftohje	Me shpejtësi të lartë/mesatare/të ulët të ventilatorit	dBa	40.0/38.0/36.0	47.0/44.0/40.0
	Ngrohje	Me shpejtësi të lartë/mesatare/të ulët të ventilatorit	dBa	40.0/38.0/36.0	47.0/44.0/40.0
Ftohës	Lloi/GWP	R-410A/2,087.5			
Lidhjet e tubacioneve	E lëngshme	OD	mm	9.5	
	Gaz	OD	mm	15.9	
	Kullojeni			I.D. 20/O.D. 26	
Furnizimi me energji elektrike	Faza/Frekuenca/Tensioni	Hz/V	1~/50/60/220-240/220-230		
Aktuale - 50Hz	Amplifikatorët maksimalë të siguresave (MFA)	A	16		
Sistemet e kontrollit	Telekomandë infra të kuqe	BRC7C58			
	Telekomanda me tela	BRC1H52W/S/K/ BRC1E53A/ BRC1E53B/ BRC1E53C/ BRC1D52			



VRV-Daikin Tavanore FXCQ-A

Daikin zgjidhje per ambientin tuaj

FXCQ-A

Njesi VRV tavanore



FXCQA



BRC1H52W , BRC7C52

Karakteristikat dhe funksionet



Njësia e brendshme			FXCQ	20A	25A	32A	40A	50A	63A	80A	125A	
Kapaciteti ftohës	Totali ventilatorit	Me kapacitet të lartë të	kW	2.2	2.8	3.6	4.5	5.6	7.1	9.0	14.0	
Kapaciteti i ngrohjes	Totali ventilatorit	Me kapacitet të lartë të	kW	2.5	3.2	4.0	4.0	6.3	8.0	10.0	16.0	
Fuqia hyrëse - 50Hz	Ftohje	Me shpejtësi të lartë të ventilatorit	kW	0.031	0.039		0.041	0.059	0.063	0.090	0.149	
	Ngrohje	Me shpejtësi të lartë të ventilatorit	kW	0.028	0.035		0.037	0.056	0.060	0.086	0.146	
Dimensioni	Njësia	Lartësi x Gjerësi x Thellësia	mm		305x775x620			305x990x620		305x1,445x620		
Pesha	Njësia		kg		19			22	25	33	38	
Shtresë e jashtme	Material			Pllakë çeliku e galvanizuar								
Paneli dekorativ	Modeli			BYBCQ40HW1			BYBCQ63HW1			BYBCQ125W1		
	Ngjyrë			E bardhë e freskët (6.5Y 9.5/0.5)								
		Lartësi x Gjerësi x Thellësia	mm		55x1,070x700			55x1,285x700			55x1,740x700	
	Pesha		kg		10			11			13	
Fan	Rrjedha e ajrit lartë/mesatare	Ftohje me shpejtësi të lartë / mesatare - 50Hz shpejtësi të ulët të ventilatorit	m ³ /min	10.5/9/7.5	11.5/9.5/8	12/10.5/8.5	15/13/10.5	16/14/11.5	26/22.5/18.5	32/27.5/22.5		
Filtri i ajrit	Loji			Rrjetë rrëshirë me rezistencë ndaj mykut								
Niveli i fuqisë së zërit	Ftohje	Me shpejtësi të lartë / mesatare / të ulët të ventilatorit	dB(A)	48/46/44	50/47/45	50/48/46	52/49/47	53/51/47	55/53/48	58/54/49	62/58/54	
Niveli i presionit të zërit	Ftohje	Me shpejtësi të lartë / mesatare / të ulët të ventilatorit	dB(A)	32.0/30.0/28.0	34.0/31.0/29.0	34.0/32.0/30.0	36.0/33.0/31.0	37.0/35.0/31.0	39.0/37.0/32.0	42.0/38.0/33.0	46.0/42.0/38.0	
	Ngrohje	Me shpejtësi të lartë / mesatare / të ulët të ventilatorit	dB(A)	32.0/30.0/28.0	34.0/31.0/29.0	34.0/32.0/30.0	36.0/33.0/31.0	37.0/35.0/31.0	39.0/37.0/32.0	42.0/38.0/33.0	46.0/42.0/38.0	
Ftohës	Loji/GWP			R-410A/2.087.5								
Lidhjet e tubacioneve	E lëngshme	OD	mm	6.35			9.52					
	Gaz	OD	mm	12.7			15.9					
	Kullojeni			VP25 (O.D. 32 / I.D. 25)								
Furnizimi me energji elektrike	Faza/Frekuenca/Tensioni		Hz/V	1~/50/220-240								
Rryma -50Hz	Amplifikatorët maksimalë të siguresave(MFA)		A	16								
Sistemet e kontrollit	Telekomandë infra të kuqe			BRC7C52								
	Telekomanda me tela			BRC1H52W/S/K/ BRC1E53A/ BRC1E53B/ BRC1E53C/ BRC1D52								



VRV-Daikin Tavanore FXKQ-MA

Daikin zgjidhje per ambientin tuaj

FXKQ-MA

Njesi VRV tavanore



FXKQ-MA



BRC1H52W , BRC4C61

Panele Diellore

Ngrohje & Ftohje

Hidraulike

Hidrosanitare

Aksesore të ndryshëm

Njësia e brendshme			FXKQ	25MA	32MA	40MA	63MA
Kapaciteti ftohës	Totali	Me kapacitet të lartë të ventilatorit	kW	2.8	3.6	4.5	7.10
Kapaciteti i ngrohjes	Totali	Me kapacitet të lartë të ventilatorit	kW	3.2	4.0	5.0	8.00
Fuqia hyrëse - 50Hz	Ftohje	Me shpejtësi të lartë të ventilatorit	kW	0.066		0.076	0.105
	Ngrohje	Me shpejtësi të lartë të ventilatorit	kW	0.046		0.056	0.085
Dimensioni	Njësia	LartësiaxGjerësiaxThellësia	mm		215x1,110x710		215x1,310x710
Pesha	Njësia		kg		31		34
Shtresë e jashtme	Material				Pllakë çeliku e galvanizuar		
Paneli dekorativ	Modeli				BYK45FJW1		BYK71FJW1
	Ngjyrë				E bardhë		
		LartësiaxGjerësiaxThellësia	mm		70X1,240X800		70X1,440X800
	Pesha		kg		8.5		9.5
Fan	Rrjedha e ajrit	Ftohje me shpejtësi të lartë/mesatare - 50Hz shpejtësi të ulët të ventilatorit	m ³ /min	11/9		13/10	18/15
Filtri i ajrit	Lloji			Rrjetë rrëshirë me rezistencë ndaj mykut			
Niveli i fuqisë së zërit	Ftohje	Me shpejtësi të lartë / mesatare / të ulët të ventilatorit	dBa	54/49		56/50	58/53
Niveli i presionit të zërit	Ftohje	Me shpejtësi të lartë / mesatare / të ulët të ventilatorit	dBa	38.0/33.0		40.0/34.0	42.0/37.0
Ftohës	Lloji/GWP			R-410A/2.087.5			
Lidhjet e tubacioneve	E lëngshme	OD	mm		6.4		9.5
	Gaz	OD	mm		12.7		15.9
	Kullojeni				VP25 (O.D. 32 / I.D. 25)		
Furnizimi me energji elektrike	Faza/Frekuenca/Tensioni		Hz/V	1~/50/60/220-240/220			
Rryma -50Hz	Amplifikatorët maksimalë të siguresave(MFA)		A	15			
Sistemet e kontrollit	Telekomandë infra të kuqe			BRC4C61			
	Telekomanda me tela			BRC1H52W/S/K/ BRC1E53A/ BRC1E53B/ BRC1E53C/ BRC1D52			



VRV - Daikin Kasete FXZA-A

Daikin zgjidhje per ambientin tuaj

FXZA - A

Kondicioner kasete

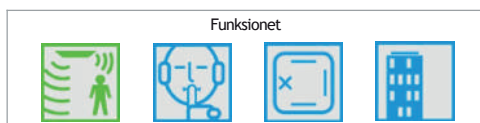
Karakteristikat dhe funksionet



Njësia e brendshme		FXZA	15A	20A	25A	32A	40A	50A
Kapaciteti ftohës	Me shpejtësi të lartë të ventilatorit	kW	1.70	2.20	2.80	3.60	4.50	5.60
Kapaciteti i ngrohjes	Me shpejtësi të lartë të ventilatorit	kW	1.90	2.50	3.20	4.00	5.00	6.30
Fuqia hyrëse - 50Hz	Ftohja	Me shpejtësi të lartë të ventilatorit	kW	0.018	0.020	0.019	0.029	0.048
	Ngrohje	Me shpejtësi të lartë të ventilatorit	kW	0.018	0.020	0.019	0.029	0.048
Dimensione	Njësia HeightxWidthxDepth	mm	260x575x575					
Pesha	Njësia	kg	15.5			16.5		18.5
Shtresë e jashtme	Materiali	Pllakë çeliku e galvanizuar						
Paneli dekorativ	Modeli	BYFQ60C4W1W						
	Ngjyrë	E bardhe (N9.5)						
	LartësiaxGjerësiaxThellësia	mm	46x620x620					
	Pesha	kg	2.8					
Paneli dekorativ 2	Modeli	BYFQ60C4W1S						
	Ngjyrë	Argjendi						
	LartësiaxGjerësiaxThellësia	mm	46x620x620					
	Pesha	kg	2.8					
Paneli dekorativ 3	Modeli	BYFQ60B3W1 + parzmore teli EKRS23						
	Ngjyrë	E bardhe (RAL9010)						
	LartësiaxGjerësiaxThellësia	mm	55x700x700					
	Pesha	kg	2.7					
Fan ajritnorma -50Hz	Rrjedha e Ftohje	Në m ³ /min të lartë/mesatar/shpejtësi e ulët e ventilatorit	8.5/7.0/6.5	8.7/7.5/6.5	9.0/8.0/6.5	10.0/8.5/7.0	11.5/9.5/8.0	14.0/12.5/10.0
		Ngrohje	Në m ³ /min të lartë/mesatar/shpejtësi e ulët e ventilatorit	8.5/7.0/6.5	8.7/7.5/6.5	9.0/8.0/6.5	10.0/8.5/7.0	11.5/9.5/8.0
Filtri i ajrit	Lloji	Rrjetë rrëshirë						
Niveli i fuqisë së zërit	Ftohje	Me shpejtësi të lartë të ventilatorit	dBa	49	50	51	54	60
Niveli i presionit të zërit	Ftohja	dBa	31.5/28.0/25.5	32.0/29.5/25.5	33.0/30.0/25.5	33.5/30.0/26.0	37.0/32.0/28.0	43.0/40.0/33.0
	Ngrohje	dBa	31.5/28.0/25.5	32.0/29.5/25.5	33.0/30.0/25.5	33.5/30.0/26.0	37.0/32.0/28.0	43.0/40.0/33.0
Ftohës	lloji/GWP	R-32/675.0						
Lidhjet e tubacioneve të lëngshme	OD	mm	6					
	Gaz	OD	mm	9.52			12.70	
	Kullojeni	VP20 (I.D. 20/O.D. 26)						
Furnizimi me energji elektrike	Faza/Frekuenca/Tensioni	Hz/V	1~/50/60/220-240/220					
Rryma - 50Hz	Amplifikatorët maksimalë të siguresave (MFA)	A	6					
Sistemet e kontrollit	Telekomandë infra të kuqe	BRC7F530W(panel i bardhë) / BRC7F530S(panel gri) / BRC7EB530W (panel standard) (1)						
Sistemet e kontrollit	Telekomanda me tela	BRC1H52W/S/K						



VRV - Daikin Kasete FXZQ-A

Daikin zgjidhje per ambientin tuaj

FXZQ - A

Kondicioner kasete

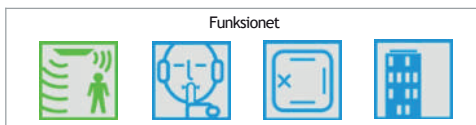
Karakteristikat dhe funksionet



Panele Diellore

Ngrohje & Ftohje

Hidraulike

Hidrosanitare

Aksesore të ndryshëm

Njësia e brendshme		FXZQ	15A	20A	25A	32A	40A	50A	
Kapaciteti ftohës	Total kapacitet	Me shpejtësi të lartë të ventilatorit	kW	1.70	2.20	2.80	3.60	4.50	5.60
Kapaciteti i ngrohjes	Total kapacitet	Me shpejtësi të lartë të ventilatorit	kW	1.90	2.50	3.20	4.00	5.00	6.30
Fuqia hyrëse - 50Hz	Ftohja	Me shpejtësi të lartë të ventilatorit	kW	0.018		0.020	0.019	0.029	0.048
	Ngrohje	Me shpejtësi të lartë të ventilatorit	kW	0.018		0.020	0.019	0.029	0.048
Dimensione	Njësia	LartësiaxGjerësiaxThellësia	mm	260x575x575					
Pesha	Njësia		kg	15.5			16.5		18.5
Shtresë e jashtme	Materiali			Pllakë çeliku e galvanizuar					
Paneli dekorativ	Modeli			BYFQ60C2W1W					
	Ngjyrë			E bardhe (N9.5)					
		LartësiaxGjerësiaxThellësia	mm	46x620x620					
	Pesha		kg	2.8					
Paneli dekorativ 2	Modeli			BYFQ60C2W1S					
	Ngjyrë			Argjendi					
		LartësiaxGjerësiaxThellësia	mm	46x620x620					
	Pesha		kg	2.8					
Paneli dekorativ 3	Modeli			BYFQ60B2W1					
	Ngjyrë			E bardhe (RAL9010)					
		LartësiaxGjerësiaxThellësia	mm	55x700x700					
	Pesha		kg	2.7					
Paneli dekorativ 4	Modeli			BYFQ60B3W1					
	Ngjyrë			E bardhe (RAL9010)					
		LartësiaxGjerësiaxThellësia	mm	55x700x700					
	Pesha		kg	2.7					
Fan	Rjedha e ajrit	Ftohje	Në m ³ /min të lartë/mesatar/ shpejtësi e ulët e ventilatorit	8.5/7.0/6.5	8.7/7.5/6.5	9.0/8.0/6.5	10.0/8.5/7.0	11.5/9.5/8.0	14.0/12.5/10.0
		Ngrohje	Në m ³ /min të lartë/mesatar/ shpejtësi e ulët e ventilatorit	8.5/7.0/6.5	8.7/7.5/6.5	9.0/8.0/6.5	10.0/8.5/7.0	11.5/9.5/8.0	14.0/12.5/10.0
Filtri i ajrit	Lloji			Rrjetë rrëshirë					
Niveli i fuqisë së zërit	Ftohje	Me shpejtësi të lartë të ventilatorit	dBa	49					
			dBa	31.5/28.0/25.5	32.0/29.5/25.5	33.0/30.0/25.5	33.5/30.0/26.0	37.0/32.0/28.0	43.0/40.0/33.0
Niveli i presionit të zërit	Ngrohje		dBa	31.5/28.0/25.5	32.0/29.5/25.5	33.0/30.0/25.5	33.5/30.0/26.0	37.0/32.0/28.0	43.0/40.0/33.0
				R-410/2,087.5					
Ftohës	Iloji/GWP			R-410/2,087.5					
Lidhjet e tubacioneve të lëngshme	OD		mm	6					
	Gaz	OD	mm	12.7					
	Kullojeni			VP20 (I.D. 20/O.D. 26)					
Furnizimi me energji elektrike	Faza/Frekuenca/Tensioni		Hz/V	1~/50/60/220-240/220					
Rryma - 50Hz	Amplifikatorët maksimalë të siguresave (MFA)	A		16					
Sistemet e kontrollit	Telekomandë infra të kuqe			BRC7F530W(panel i bardhë) / BRC7F530S(panel gri) / BRC7EB530W (panel standard) (1)					
Sistemet e kontrollit	Telekomanda me tela			BRC1H52W/S/K/ BRC1E53A/ BRC1E53B/ BRC1E53C / BRC1D52					



VRV - Daikin Kasete FXFA-A

Daikin zgjidhje per ambientin tuaj

FXFA-A

Kondicioner kasete

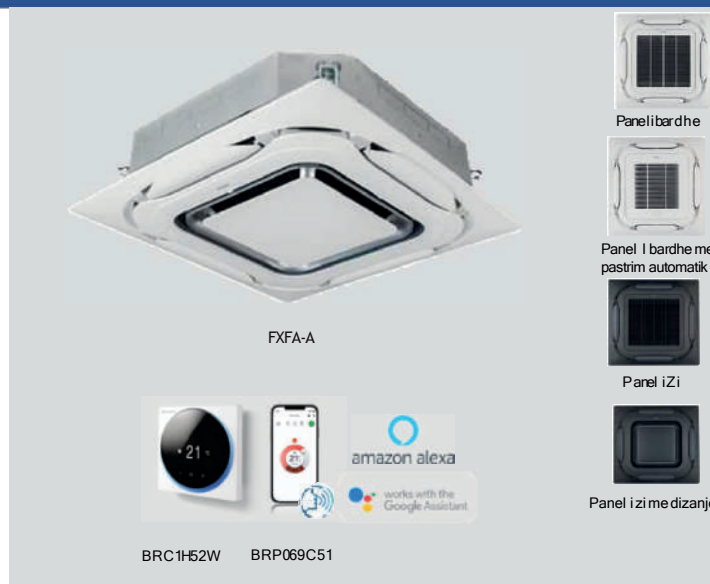
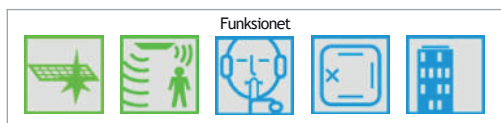
Karakteristikat dhe funksionet



Njësia e brendshme		FXFA		20A	25A	32A	40A	50A	63A	80A	100A	125A							
Kapaciteti ftohës	Total kapacitet	Me shpejtësi të lartë të ventilatorit		kW	2.20	2.80	3.60	4.50	5.60	7.10	9.00	11.20	14.00						
	Kapaciteti i ngrohjes	Total kapacitet	Me shpejtësi të lartë të ventilatorit		kW	2.50	3.20	4.00	5.00	6.30	8.00	10.00	12.50	16.00					
Fuqia hyrëse - 50Hz	Ftohja	Me shpejtësi të lartë të ventilatorit		kW	0.017			0.018	0.023	0.028	0.045	0.078	0.103						
		Ngrohja		Me shpejtësi të lartë të ventilatorit	kw	0.017			0.018	0.023	0.028	0.045	0.078	0.103					
Dimensione	Njësia	Lartësi x Gjerësi x Thellësia		mm	204x840x840			246x840x840			288x840x840								
Pesha	Njësia			kg	18			19		21		24	26						
Shtresë e jashtme	Materiali		Pllakë çeliku e galvanizuar																
Paneli dekorativ	Modeli		Panele standarde: BYCQ140E2W1 - e bardhë me grila gri / BYCQ140E2W1W - e bardhë e plotë / BYCQ140E2W1B - e zezë Panelet e pastrimit automatik: BYCQ140E2GFW1 - e bardhë / BYCQ140E2GFW1B - e zezë Panele projektuese: BYCQ140E2P - e bardhë / BYCQ140E2PB - e zezë																
	Lartësi x Gjerësi x Thellësia		mm		Panelet standarde: 65x950x950 / Panelet e pastrimit automatik: 148x950x950 / Panelet projektuese: 106x950x950														
	Pesha		kg		Panelet standarde: 5.5 / Panelet e pastrimit automatik: 10.3 / Panelet projektuese: 6.5														
Fan	Rrjedha e ajrit 50Hz	Ftohje	Në m³/min të lartë/mesatar/ shpejtësi e ulët e ventilatorit		12.8/11.8/10.7/9.8/8.9			14.8/13.7/12.6/11.5/10.4		15.1/14.0/12.8/11.8/10.7		16.6/15.0/13.8/12.0/10.7		23.3/21.7/19.2/17.5/13.8		28.8/25.1/21.0/17.5/13.8		33.0/30.2/27.0/24.0/20.6	
			Ngrohje	Në m³/min të lartë/mesatar/ shpejtësi e ulët e ventilatorit		12.8/11.8/10.7/9.8/8.9			14.8/13.7/12.6/11.5/10.4		15.1/14.0/12.8/11.8/10.7		16.6/15.0/13.8/12.0/10.7		23.3/21.7/19.2/17.5/13.8		29.0/25.1/21.0/17.5/13.8		33.0/30.2/27.0/24.0/20.6
Filteri i ajrit	Lloji			Rrëshirë															
Niveli i fuqisë së zërit	Ftohje	Me shpejtësi të lartë të ventilatorit		dB(A)	49.0			51.0		53.0		55.0		60.0		61.0			
Niveli i presionit të zërit	Ftohje	Me shpejtësi të lartë / mesatare të lartë / mesatare / mesatare të ulët / të ulët të ventilatorit		m³/min	31.0/30.0/29.0/29.5/28.0			33.0/32.0/31.0/30.0/29.0		35.0/34.0/33.0/32.0/30.0		38.0/36.0/34.0/32.0/30.0		43.0/41.0/37.0/34.0/30.0		45.0/43.0/41.0/39.0/36.0			
		Ngrohje		Me shpejtësi të lartë / mesatare të lartë / mesatare / mesatare të ulët / të ulët të ventilatorit	m³/min	31.0/30.0/29.0/29.5/28.0			33.0/32.0/31.0/30.0/29.0		35.0/34.0/33.0/32.0/30.0		38.0/36.0/34.0/32.0/30.0		43.0/41.0/37.0/34.0/30.0		45.0/43.0/41.0/39.0/36.0		
Ftohës	Lloji/GWP		R-32/675.0																
Lidhjet e tubacioneve	E lëngshme	OD	mm					6					10						
		Gaz	OD	mm		9.52			12.70			15.90							
	Kullojeni		VP25(O.D.32 / I.D.25)																
Furnizimi me energji elektrike	Faza/Frekuenca/Tensioni		1~/50/60/220-240/220																
Rryma - 50 Hz	Amplifikatorët maksimalë të siguresave (MFA)		6																
Sistemet e kontrollit	Telekomandë infra të kuqe		BRC7FA532F / BRC7FB532F / BRC7FA532FB / BRC7FB532FB																
	Telekomanda me tela		BRC1H52W/S/K																



VRV - Daikin Kasete FXFQ-B

Daikin zgjidhje per ambientin tuaj

FXFQ-B

Kondicioner kasete

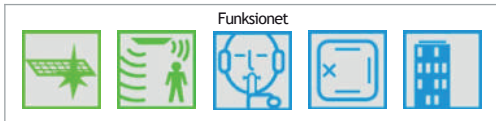
Karakteristikat dhe funksionet



Panele Djellore

Ngrohje & Ftohje

Hidraulike

Hidrosanitare

Aksesore të ndryshëm

Njësia e brendshme		FXFQ	20B	25B	32B	40B	50B	63B	80B	100B	125B			
Kapaciteti ftohës	Kapaciteti total	Me shpejtësi të lartë të ventilatorit	kW	2.20	2.80	3.60	4.50	5.60	7.10	9.00	11.20	14.00		
Kapaciteti i ngrohjes	Kapaciteti Total	Me shpejtësi të lartë të ventilatorit	KW	2.50	3.20	4.00	5.00	6.30	8.00	10.00	12.50	16.00		
Fuqia hyrëse - 50Hz	Ftohje	Me shpejtësi të lartë të ventilatorit	kW		0.017		0.018	0.023	0.028	0.045	0.071	0.103		
	Ngrohje	Me shpejtësi të lartë të ventilatorit	kW		0.017		0.018	0.023	0.028	0.045	0.071	0.103		
Dimensioni	Njësia	Lartësi x Gjerësi x Thellësia	mm	204x840x840										
Pesha	Njësia		kg	18		19		21		24		26		
Shtresë	Material	Pllakë çeliku e galvanizuar												
Paneli dekorativ	Modeli	Panelet standarde: BYCQ140E - e bardhë me grila gri / BYCQ140EW - e bardhë e plotë / BYCQ140EB - e zezë Panelet e pastrimit automatik: BYCQ140EGF - e bardhë / BYCQ140EGFB - e zezë Panele projektuese: BYCQ140EP - e bardhë / BYCQ140EPB - e zezë												
		Lartësi x Gjerësi x Thellësia	mm	Panelet standarde: 65x950x950 / Panelet e pastrimit automatik: 148x950x950 / Panelet projektuese: 106x950x950										
	Pesha		kg	Panelet standarde: 5.5 / Panelet e pastrimit automatik: 10.3 / Panelet projektuese: 6.5										
Fan	Rrjedha e ajrit norma - 50Hz	Ftohje	Me shpejtësi të lartë / mesatare m ³ /min / të ulët të ventilatorit	12.8/10.7/8.9			14.8/12.6/10.7 15.1/12.9/10.7 16.6/12.9/10.7 23.3/19.2/13.5 27.8/20.4/13.0 31.6/26.0/19.8							
		Ngrohje	Me shpejtësi të lartë / mesatare m ³ /min / të ulët të ventilatorit	12.8/10.7/8.9			14.8/12.6/10.7 15.1/12.9/10.7 16.6/12.9/10.7 22.5/18.5/13.0 27.8/20.4/13.0 30.3/24.9/18.9							
Filtri i ajrit	Lloji	Rrjetë rrëshirë												
Niveli i fuqisë së zërit	Ftohje	Me shpejtësi të lartë të ventilatorit	dBA	49.0			51.0		53.0		55.0		60.0	61.0
Niveli i presionit të zërit	Ftohje		dBA	31.0/29.0/28.0			33.0/31.0/29.0		35.0/33.0/30.0		38.0/33.0/30.0		43.0/37.0/30.0	45.0/41.0/36.0
	Ngrohje		dBA	31.0/29.0/28.0			33.0/31.0/29.0		35.0/33.0/30.0		38.0/33.0/30.0		43.0/37.0/30.0	45.0/41.0/36.0
Ftohes	Lloji/GWP	R-410A/2,087.5												
Lidhjet e tubacioneve	E lëngshme	OD	mm	6			10							
	Gaz	OD	mm	12.70			15.90							
	Kullojeni			VP25 (O.D. 32 / I.D. 25)										
Furnizimi me energji elektrike	Faza/Frekuenca/Tensioni		Hz/V	1~/50/60/220-240/220										
Ryma - 50Hz	Amplifikatorët maksimalë të siguresave (MFA)	A		16										
Sistemet e kontrollit	Telekomandë infra të kuqe	BRC7FA532F / BRC7FB532F / BRC7FA532FB / BRC7FB532FB												
	Telekomanda me tela	BRC1H52W/S/K / BRC1E53A / BRC1E53B / BRC1E53C / BRC1D52												

VRV - Daikin Kanalor FXDA-A

Daikin zgjidhje per ambientin tuaj

FXDA-A

Kondicioner kanalor

Karakteristikat dhe funksionet



Njësia e brendshme			FXDA	10A	15A	20A	25A	32A	40A	50A	63A
Kapaciteti ftohës	Totali ventilatorit	Me kapacitetet te larte te	kW	1.10	1.70	2.20	2.80	3.60	4.50	5.60	7.10
Kapaciteti i ngrohjes	Totali ventilatorit	Me kapacitetet të lartë të	kW	1.30	1.90	2.50	3.20	4.00	5.00	6.30	8.00
Fuqia hyrëse - 50Hz	Ftohje	Me shpejtësi të lartë të ventilatorit	kW	0.026	0.035	0.030	0.035	0.038	0.049	0.058	
	Ngrohje	Me shpejtësi të lartë të ventilatorit	kW	0.026	0.035	0.030	0.035	0.038	0.049	0.058	
Zbrazëtia e kërkuar e tavanit >			mm	240							
Dimensioni	Njësia	LartësiaxGjerësiaxThellësia	mm	200x750x620			200x950x620			200x1,150x620	
Pesha	Njësia		kg	22.0		23.0		26.5		30.5	
Shtresë e jashtme	Material			Çeliku i galvanizuar							
Fan -Shkalla rrydhës së ajrit - 50 Hz	Ftohje	Me shpejtësi të lartë / mesatare m ³ /min / të ulët të ventilatorit		5.2/4.9/4.7	6.5/6.2/5.8	8.0/7.2/6.4		10.5/9.5/8.5	12.5/11.0/10.0	16.5/14.5/13.0	
	Ngrohje	Me shpejtësi të lartë / mesatare m ³ /min / të ulët të ventilatorit		5.2/4.9/4.7	6.5/6.2/5.8	8.0/7.2/6.4		10.5/9.5/8.5	12.5/11.0/10.0	16.5/14.5/13.0	
-Presioni statik i jashtëm - 50 Hz	Kompleti i fabrikës / Lartë		Pa	10/30			15/44				
Filtri i ajrit	Lloji			I lëvizshëm/lahet							
Niveli i fuqisë së zërit	Ftohje	Me shpejtësi të lartë të ventilatorit	dBA	48	50	51		52	53	54	
Niveli i presionit të zërit	Ftohje	Me shpejtësi të lartë / mesatare / të ulët të ventilatorit	dBA	29.0/28.0/26.0	32.0/31.0/27.0	33.0/31.0/27.0		34.0/32.0/28.0	35.0/33.0/29.0	36.0/34.0/30.0	
	Ngrohje	Me shpejtësi të lartë / mesatare / të ulët të ventilatorit	dBA	29.0/28.0/26.0	32.0/31.0/27.0	33.0/31.0/27.0		34.0/32.0/28.0	35.0/33.0/29.0	36.0/34.0/30.0	
Ftohës	Lloji/GWP			R-32/675.0							
Lidhjet e tubacioneve	E lëngshme	OD	mm	6							
	Gaz	OD	mm	9.52			12.7				
	Kullojeni			VP20 (I.D. 20/O.D. 26)							
Furnizimi me energji elektrike	Faza/Frekuenca/Tensioni		Hz/V	1~/50/60/220-240/220							
Rryma -50Hz	Amplifikatorët maksimalë të siguresave(MFA)		A	6							
Sistemet e kontrollit	Telekomandë infra të kuqe			BRC4C65 (1)							
	Telekomanda me tela			BRC1H52W/S/K							



VRV - Daikin Kanalor FXDQ-A3

Daikin zgjidhje për ambientin tuaj

FXDQ-A3

Kondicioner kanalor

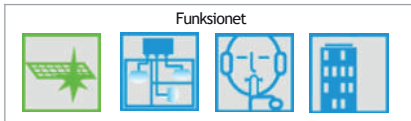
Karakteristikat dhe funksionet



Njësia e brendshme		FXDQ	15A3	20A3	25A3	32A3	4A3	50A3	63A3		
Kapaciteti ftohës	Nom.	kW	1.7	2.2	2.8	3.6	4.5	5.6	7.1		
Kapaciteti i ngrohjes	Nom.	kW	1.9	2.5	3.2	4.0	5.0	6.3	8.0		
Fuqia hyrëse - 50Hz	Ftohje	Me shpejtësi të lartë të ventilatorit	kW	0.036	0.041	0.042	0.053	0.062	0.062		
	Ngrohje									Me shpejtësi të lartë të ventilatorit	0.036
Zbrazëtia e kërkuar e tavanit >		mm	240								
Dimensioni	Njësia	Lartësi x Gjerësi x Thellësia	mm			200x750x620			200x950x950	200x1100x950	
Pesha	Njësia	kg	22			26			29		
Shtresë	Material		Çeliku i galvanizuar								
Fan	Rrjedha e ajrit	Ftohje	Me shpejtësi të lartë / mesatare	7.5/7.0/6.4		8.0/7.2/6.4		10.5/9.5/8.5		12.5/11.0/10.0	16.5/14.5/13.0
				m ³ /min - 50Hz/ shpejtësi të ulët të ventilatorit							
			Kompleti i fabrikës / Lartë	Pa		10 / 30.0		15 / 44.0			
Filtri i ajrit	Lloji	I lëvizshëm/lahet									
Niveli i fuqisë së zërit	Ftohje	Me shpejtësi të lartë të ventilatorit	dBA	50		51		52		53	54
Niveli i presionit të zërit	Ftohje		dBA	32.0/31.0/27.0		33.0/31.0/27.0		34.0/32.0/28.0		35.0/33.0/29.0	36.0/34.0/30.0
Ftohës	Lloji/GWP	R-410A/2087.5									
Lidhjet e tubacioneve	të lëngshme	OD	mm	6			12.7			10	
	Gaz	OD	mm	12.7			15.9				
	Drain	VP20 (I.D. 20/O.D. 26)									
Furnizimi me energji elektrike	Faza/Frekuenca/Tensioni	Hz/V	1~/50/60/220-240/220								
Rryma - 50Hz	Amplifikatorët maksimalë të siguresave (MFA)	A	16								
Sistemet e kontrollit	Telekomandë infra të kuqe	BRC4C65 / BRC4C66									
	Telekomanda me tela	BRC1D528 / BRC1E51									

Panele Diellore

Ngrohje & Ftohje

Hidraulike

Hidrosanitare

Aksesore të ndryshëm

VRV - Daikin Kanalor FXMA-A

Daikin zgjidhje per ambientin tuaj

FXMA-A

Kondicioner kanalor

Karakteristikat dhe funksionet



Njësia e brendshme		FXMA	50A	63A	80A	100A	125A	200A	250A	
Kapaciteti ftohës	Me shpejtësi të lartë të ventilatorit	kW	5.6	7.1	9.0	11.2	14.0	22.4	28.0	
	Nom.	kW			-			22.4	28.0	
Kapaciteti i ngrohjes	Me shpejtësi të lartë të ventilatorit	kW	6.3	8.0	10.0	12.5	16.0	25.0	31.5	
	Nom.	kW			-			25.0	31.5	
Fuqia hyrëse - 50Hz	Ftohje Me shpejtësi të lartë të ventilatorit	kW	0.125	0.140	0.198	0.191	0.254	0.54	0.65	
	Ngrohje Me shpejtësi të lartë të ventilatorit	kW	0.125	0.140	0.198	0.191	0.254	0.54	0.65	
Zbrazëtia e kërkuar e tavanit >		mm			350					
Dimensionet	Njësia	Lartësi x Gjerësi x Thellësia	mm			300x1,400x700		470x1,490x1,100		
	Pesha	Njësia	kg	35		46		105		
Shtresë e jashtme	Materiali		Pllakë çeliku e galvanizuar							
Fan	Rrjedha e ajrit	Ftohje me shpejtësi të lartë / mesatare m ³ /min - 50Hz / shpejtësi të ulët të ventilatorit	18.0/16.5/15.0	19.5/17.5/16.0	25.0/22.5/20.0	32.0/27.0/23.0	36.0/30.0/26.0	62/48/41	74/64/52	
		Ngrohje me m ³ /min të lartë / mesatare / shpejtësi e ulët e ventilatorit	18.0/16.5/15.0	19.5/17.5/16.0	25.0/22.5/20.0	32.0/27.0/23.0	36.0/30.0/26.0	62/48/41	74/64/52	
		Kompleti i fabrikës / Lartë / i ulët	Pa	100/200/-				150/250/50		
Filtri i ajrit	Lloji		Rrjetë rrëshirë							
Niveli i fuqisë së zërit	Ftohja	dB(A)	61.0/60.0/58.0	64.0/61.0/59.0	67.0/64.0/62.0	65.0/61.0/56.0	70.0/66.0/62.0	75/74/72	76/75/73	
Niveli i presionit të zërit	Ftohje	dB(A)	41.0/39.0/37.0	42.0/40.0/38.0	43.0/41.0/39.0		44.0/42.0/40.0		48/46.5/45	
	Ngrohje	dB(A)	41.0/39.0/37.0	42.0/40.0/38.0	43.0/41.0/39.0		44.0/42.0/40.0		48/46.5/45	
Ftohës	Lloji/GWP		R-32/675							
Lidhjet e tubacioneve të lëngshme	OD	mm	6.35		9.52		9.5			
	Gaz	OD	12.70		15.90		19.1			
	Kullojeni		VP25 (I.D. 25/O.D. 32)							
Furnizimi me energji elektrike	Faza/Frekuenca/Tensioni	Hz/V	1~/50/60/220-240/220						1~/50/60/220-240/220-230	
Rryma - 50Hz	Amplifikatorët maksimalë të siguresave (MFA)	A	6						BRC4C65	
Sistemet e kontrollit	Telekomandë infra të kuqe		BRC4C65 / BRC4C66						BRC4C65	
	Telekomanda me tela		BRC1H52W/S/K							



VRV - Daikin Kanalor FXMQ-A

Daikin zgjidhje per ambientin tuaj

FXMQ-A

Kondicioner kanalor

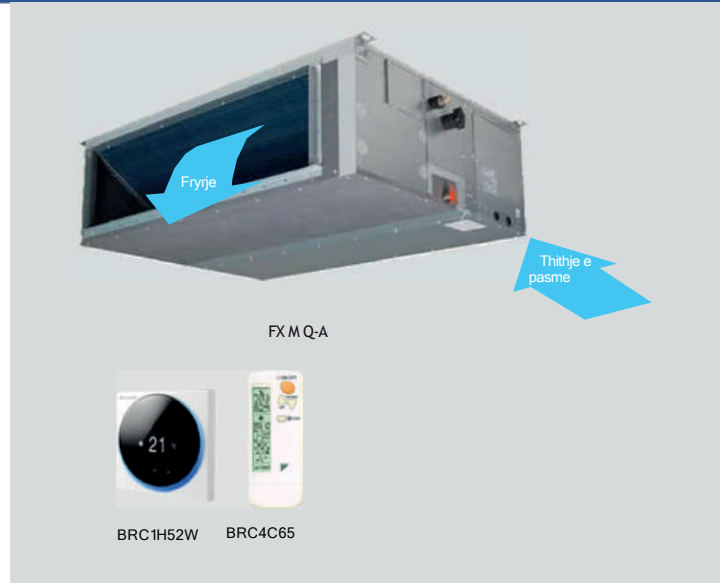
Karakteristikat dhe funksionet



Panele Diellore

Ngrohje & Ftohje

Hidraulike

Hidrosanitare

Aksesore të ndryshëm

Njësia e brendshme		FXMQ	50P7	63P7	80P7	100P7	125P7	200A	250A
Kapaciteti ftohës	Me shpejtësi të lartë të ventilatorit	kW						22.4	28.0
	Nom.	kW	5.6	7.1	9.0	11.2	14.0	22.4	28.0
Kapaciteti i ngrohjes	Me shpejtësi të lartë të ventilatorit	kW						25.0	31.5
	Nom.	kW	6.3	8.0	10.0	12.5	16.0	25.0	31.5
Fuqia hyrëse - 50Hz	Ftohje Me shpejtësi të lartë të ventilatorit	kW	0.110	0.120	0.171	0.176	0.241	0.54	0.65
	Ngrohje Me shpejtësi të lartë të ventilatorit	kW	0.098	0.108	0.159	0.164	0.229	0.54	0.65
Zbrazëtia e kërkuar e tavanit >		mm			350				
Dimensioni	Njesi Lartësi x Gjerësi x Thellësia	mm	300x1,000x700			300x1,400x700		470x1,490x1,100	
Pesha	Njesi	kg	35			46		105	
Fan	Rrjedha e ajrit Ftohje	m ³ /min	18.0/16.5/15.0	19.5/17.8/16.0	25.0/22.5/20.0	32.0/22.5/20.0	39.0/33.5/28.0	62/48/41	74/64/52
	shpejtësia - 50Hz Ngrohje	m ³ /min	18.0/16.5/15.0	19.5/17.8/16.0	25.0/22.5/20.0	32.0/22.5/20.0	39.0/33.5/28.0	62/48/41	74/64/52
	Kompleti i fabrikës / Lartë	Pa			100/200			150/250	
Filtri i ajrit	Lloji		Rrjetë rrëshirë						
Niveli i fuqisë së zërit	Ftohje Me shpejtësi të lartë/mesatare/të ulët të ventilatorit	dBa	61.0/-/-	64.0/-/-	67.0/-/-	65.0/-/-	70.0/-/-	75/74/72	76/75/73
	Ngrohje Me shpejtësi të lartë/mesatare/të ulët të ventilatorit							75/74/72	76/75/73
Niveli i presionit të zërit	Ftohje Me shpejtësi të lartë/mesatare/të ulët të ventilatorit	dBa	41.0/39.0/37.0	42.0/40.0/38.0	43.0/41.0/39.0	44.0/42.0/40.0		48/46.5/45	
	Ngrohje Me shpejtësi të lartë/mesatare/të ulët të ventilatorit	dBa	41.0/39.0/37.0	42.0/40.0/38.0	43.0/41.0/39.0	44.0/42.0/40.0		48/46.5/45	
Ftohës	Lloji/GWP				R-410A/-			R-410A/2087.5	
Lidhjet e tubacioneve të lëngshme	OD	mm	6.35			9.52			
	Gaz OD	mm	12.7			15.9		19.1	22.2
	Drain					VP (I.D. 25/O.D. 32)		BSP1	
Furnizimi me energji elektrike	Faza/Frekuenca/Tensioni	Hz/V	1~/50/60/220-240/220 +/-10%						
Rryma - 50Hz	Amplifikatorët maksimalë të siguresave (MFA)	A	6						1~/50 /220-240
Sistemet e kontrollit	Telekomandë infra të kuqe		BRC4C65						
	Telekomanda me tela		BRC1H52W/S/K/BRC1E53A/BRC1E53B/BRC1E53C/BRC1D52						

VRV - Daikin Kanalor FXNQ-A

Daikin zgjidhje per ambientin tuaj

FXNQ-A

Kondicioner kanalor

Karakteristikat dhe funksionet



Njësia e brendshme		FXNQ	20A	25A	32A	40A	50A	63A		
Kapaciteti ftohës	Totali	Me kapacitet te larte te ventilatorit	kW	2.20	2.80	3.60	4.50	5.60	7.10	
	Me kapacitet të lartë të ventilatorit		kW	2.50	3.20	4.00	5.00	6.30	8.00	
Kapaciteti i ngrohjes	Totali	Me shpejtësi të lartë të ventilatorit	kW	2.50	3.20	4.00	5.00	6.30	8.00	
	Me shpejtësi të lartë të ventilatorit		kW	2.50	3.20	4.00	5.00	6.30	8.00	
Fuqia hyrëse - 50Hz	Ftohje	Me shpejtësi të lartë të ventilatorit	kW		0.071		0.078	0.099	0.110	
	Ngrohje		kW		0.068		0.075	0.096	0.107	
Dimensioni	Njësia	Lartësi x Gjerësi x thellësia	mm	620/720x790x200			620/720x990x200		620/720x1.190x200	
Pesha	Njësia		kg	23.5			27.5		32.0	
Shtresë e jashtme	Material	Pllakë çeliku e galvanizuar								
Fan - Shkalla rrydhës së ajrit - 50 Hz	Ftohje	Me shpejtësi të lartë / mesatare m³/min / të ulët të ventilatorit		8.0/7.20/6.4		10.5/9.50/8.5		12.5/11.0/10.0	16.5/14.5/13.0	
	Ngrohje			8.0/7.20/6.4		10.5/9.50/8.5		12.5/11.0/10.0	16.5/14.5/13.0	
Presioni statik i jashtëm - 50 Hz	Kompleti i fabrikës / Lartë		Pa	10/41.0		10/42.0		15/52.0	15/59.0	15/55.0
Filtri i ajrit	Lloji	Rrjetë rrëshirë								
Niveli i fuqisë së zërit	Ftohje	Me shpejtësi të lartë të ventilatorit	dB(A)	51		52		53	54	
Niveli i presionit të zërit	Ftohje	Me shpejtësi të lartë / mesatare / të ulët të ventilatorit	dB(A)	30.0/28.5/27.0		32.0/30.0/28.0		33.0/31.0/29.0	35.0/33.0/32.0	
	Ngrohje	Me shpejtësi të lartë / mesatare / të ulët të ventilatorit	dB(A)	30.0/28.5/27.0		32.0/30.0/28.0		33.0/31.0/29.0	35.0/33.0/32.0	
Ftohës	Lloji/GWP	R-410A/2087.5								
Lidhjet e tubacioneve	E lëngshme	OD	mm	6.35			9.52			
	Gaz	OD	mm	12.7			15.9			
	Kullojeni	VP20 (I.D. 20/O.D. 26)								
Furnizimi me energji elektrike	Faza/Frekuenca/Tensioni		Hz/V	1~/50/60/220-240/220						
Rryma -50Hz	Amplifikatorët maksimalë të siguresave(MFA)		A	16						
Sistemet e kontrollit	Telekomandë infra të kuqe	BRC4C65								
	Telekomanda me tela	BRC1H52W/S/K / BRC1E53A / BRC1E53B / BRC1E53C / BRC1D52								

VRV - Daikin Kanalor FXSA-A

Daikin zgjidhje për ambientin tuaj

FXSA-A

Kondicioner kanalor

Karakteristikat dhe funksionet



Njësia e brendshme		FXSA	15A	20A	25A	32A	40A	50A	63A	80A	100A	125A	140A			
Kapaciteti ftohës	Me shpejtësi të lartë të ventilatorit	kw	1.70	2.20	2.80	3.60	4.50	5.60	7.10	9.00	11.20	14.00	16.00			
Kapaciteti i ngrohjes	Me shpejtësi të lartë të ventilatorit	kw	1.90	2.50	3.20	4.00	5.00	6.30	8.00	10.00	12.50	16.00	18.00			
Fuqia hyrëse - 50Hz	Ftohje	Me shpejtësi të lartë të ventilatorit	kw	0.046		0.049	0.094	0.096	0.106	0.143	0.176	0.216	0.272			
	Ngrohje	Me shpejtësi të lartë të ventilatorit	kw	0.046		0.049	0.094	0.096	0.106	0.143	0.176	0.216	0.272			
Dimensionet	Njësia LartësiaxGjerësiaxThellësia	mm	245x550x800			245x700x800			245x1,000x800		245x1,400x800		245x1550x800			
Pesha	Njësia	kg	23.5			28.5		29.0		35.5		46.0		51.0		
Shtresë e jashtme	Material	Pllakë çeliku e galvanizuar														
Fan	Rrjedha e ajrit	Ftohje me shpejtësi të lartë / mesatare m ³ /min - 50Hz / shpejtësi të ulët të ventilatorit	8.7/7.5/6.5	9.0/7.5/6.5	9.5/8.0/7.0/15.0/12.5/11.0/15.2/12.5/11.0/21.0/18.0/15.0/23.0/19.5/16.0/32.0/27.0/23.0/36.0/31.5/26.0									39.0/34.0/28.0		
		Ngrohje me m ³ /min të lartë / mesatare / shpejtësi e ulët e ventilatorit	8.7/7.5/6.5	9.0/7.5/6.5	9.5/8.0/7.0/15.0/12.5/11.0/15.2/12.5/11.0/21.0/18.0/15.0/23.0/19.5/16.0/32.0/27.0/23.0/36.0/31.5/26.0									42.5/34.0/28.0		
		Kompleti i fabrikës / Lartë	Pa	30/150					40/150			50/150				
Filtri i ajrit	Lloji	Rrjetë rrëshirë														
Niveli i fuqisë së zërit	Ftohje Me shpejtësi të lartë të ventilatorit	dBa	54			55			60		59		61		64	
Niveli i presionit të zërit	Ftohje	dBa	29.5/28.0/25.0			30.0/28.0/25.0			31.0/29.0/26.0		35.0/32.0/29.0		33.0/30.0/27.0/35.0/32.0/29.0/36.0/34.0/31.0/39.0/36.0/31.0		41.5/38.0/34.0	
	Ngrohje	dBa	31.5/29.0/26.0			32.0/29.0/26.0			33.0/30.0/27.0		37.0/34.0/29.0		35.0/32.0/28.0/37.0/34.0/30.0/37.0/34.0/31.0/40.0/37.0/33.0		42.5/38.5/34.0	
Ftohes	Lloji/GWP	R-32/675.0														
Lidhjet e tubacioneve	E lëngshme	OD	mm			6							10			
	Gaz	OD	mm			9.52			12.70				15.90			
	Kullojeni		VP20 (I.D. 20/O.D. 26), lartësia e kullimit 625 mm													
Furnizimi me energji elektrike	Faza/Frekuenca/Tensioni	Hz/V	1~/50/60/220-240/220													
Rryma - 50Hz	Amplifikatorët maksimalë të siguresave (MFA)	A	6													
Sistemet e kontrollit	Telekomandë infra të kuqe	BRC4C65 / BRC4C66 (1)														
	Telekomanda me tela	BRC1H52W/S/K														

Panele Diellore

Ngrohje & Ftohje

Hidraulike

Hidrosanitare

Aksesore të ndryshëm



VRV - Daikin Kanalor FXSQ-A

Daikin zgjidhje per ambientin tuaj

FXSQ-A

Kondicioner kanalor

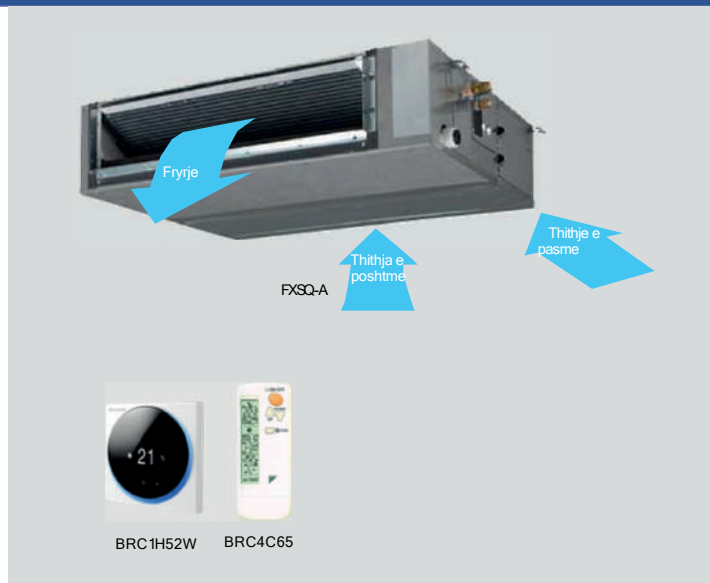
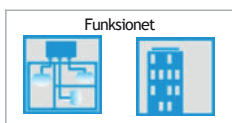
Karakteristikat dhe funksionet



Njësia e brendshme		FXSQ	15A	20A	25A	32A	40A	50A	63A	80A	100A	125A	140A					
Kapaciteti ftohës	Me shpejtësi të lartë të ventilatorit	kw	1.70	2.20	2.80	3.60	4.50	5.60	7.10	9.00	11.20	14.00	16.00					
Kapaciteti i ngrohjes	Me shpejtësi të lartë të ventilatorit	kw	1.90	2.50	3.20	4.00	5.00	6.30	8.00	10.0	12.5	16.0	18.0					
Fuqia hyrëse - 50Hz	Ftohje	Me shpejtësi të lartë të ventilatorit	kw	0.041		0.045	0.087	0.089	0.101	0.135	0.173	0.237	0.247					
	Ngrohje	Me shpejtësi të lartë të ventilatorit	kw	0.041		0.045	0.087	0.089	0.101	0.135	0.173	0.237	0.247					
Dimensioni	Njësia	LartësiaxGjerësiaxThellësia	mm	245x550x800			245x700x800			245x1,000x800			245x1,400x800					
Pesha	Njësia		kg	23.5			24.0			28.5			29.0					
Shtresë e jashtme	Materiale			Pllakë çeliku e galvanizuar														
Fan	Rrjedha e ajrit Ftohje	Me shpejtësi të lartë / mesatare	8.7/7.50/6	9.0/7.50/6.5			9.5/8.00/7			15.0/12.5/15.2/12.5/21.0/18.0/23.0/19.5/32.0/27.0/36.0/31.5/39.0/34.0/			28.0					
		m ³ /min - 50Hz / shpejtësi të ulët të ventilatorit	.5	.5			.0			11.0			11.0					
	Ngrohje	Me shpejtësi të lartë / mesatare/	8.7/7.50/6	9.0/7.50/6.5			9.5/8.00/7			15.0/12.5/15.2/12.5/21.0/18.0/23.0/19.5/32.0/27.0/36.0/31.5/39.0/34.0/			28.0					
		shpejtësi e ulët e ventilatorit	.5	.5			.0			11.0			11.0					
	Kompleti i fabrikës / Lartë		Pa				30.150			40/150			50/150					
Filtri i ajrit	Lloji			Rrjetë rrëshirë														
Niveli i fuqisë së zërit	Ftohje	Me shpejtësi të lartë të ventilatorit	dBa	54			55			60			59					
Niveli i presionit të zërit	Ftohje		dBa	29.5/28.0/25			30.0/28.0/25.0			26.0/29.0/26			35.0/32.0/29.0			33.0/30.0/27/35.0/32.0/29/36.0/34.0/31.39.0/36.0/33.41.5/38.0/34.0		
		Ngrohje	dBa	31.5/29.0/26			32.0/29.0/26.0			33.0/30.0/27			37.0/34.0/29.0			35.0/32.0/28/37.0/34.0/30/37.0/34.0/31.40.0/37.0/33.42.0/38.5/34.0		
Ftohes	Lloji/GWP			R-410A/2087.5														
Lidhjet e tubacioneve	të lëngshme	OD	mm				6						10					
	Gaz	OD	mm				12.7						15.9					
	Kullojeni			VP20 (I.D. 20/O.D. 26), lartësia e kullimit 625 mm														
Furnizimi me energji elektrike	Faza/Frekuenca/Tensioni	Hz/V		1~/50/60/220-240/220														
Rryma - 50Hz	Amplifikatorët maksimalë të siguresave (MFA)	A		16														
Sistemet e kontrollit	Telekomandë infra të kuqe			BRC4C65														
	Telekomanda me tela			BRC1E53A / BRC1E53B / BRC1E53C / BRC1D52														

VRV - Daikin HXY-A8

HXY-A8

Hidrobox me temperaturë të ulët për VRV

Për ngrohje dhe ftohje të hapësirës me efikasitet të lartë

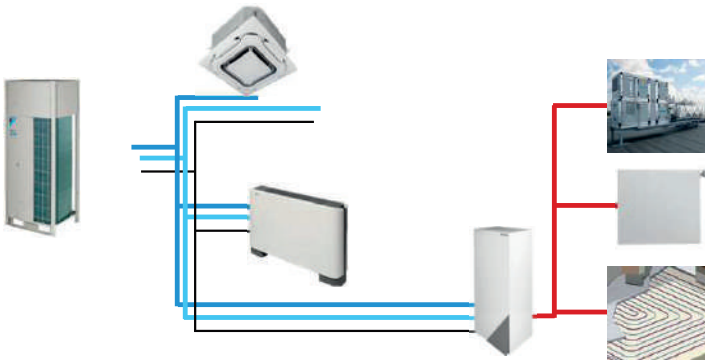

HXY-A 8

Njësia e brendshme		HXY	080A8	125A8
Kapaciteti ftohës	Nom.	kW	8.0 (1)	12.5 (1)
Kapaciteti i ngrohjes	Nom.	kW	9.00 (2)	14.00 (2)
Shtresë	Ngjyrë			E bardha
	Materiali			Llamarina e paralayer
Dimensionet	Njësia	Lartësi x Gjerësi x Thellësia	mm	890x480x344
Pesha	Njësia		kg	44.0
Gama e funksionimit	Ngrrohje	Ambient	Min.~Max.	-20 ~24 °C
		Ana e ujit	Min.~Max.	25~45 °C
	Ftohja	Ambient	Min.~Max.	10~43 °CDB
		Ana e ujit	Min.~Max.	5~20 °C
Ftohës	Lloji			R-410A
	GWP			2,087.5
Niveli i presionit të zërit	Nom.	dB(A)		31
Qarku i ftohësit	Diametri i anës së gazit	mm		15.9
	Diametri anësor i lëngshëm	mm		9.5
Qarku i ujit	Diametri i lidhjeve të tubacioneve	inch		G 1"1/4 (femër)
Furnizimi me energji elektrike	Faza / Frekuenca / Tensioni	Hz / V		1~ / 50 / 220-240
Aktuale	Siguresat e rekomanduara	A		6~ 16

Panele Dielllore

Ngrrohje & Ftohje

Hidraulike

Hidrosanitare

Aksesore të ndryshëm

RXYSA-AV1 / AY1

Seria VRV 5 S

Ekuivalent më i ulët i CO2 dhe fleksibilitet lider në treg

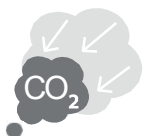

Ekuivalenti i reduktuar i CO2



Fleksibilitet për t'u kujdesur për çdo dhomë



Tashmë plotësisht në përputhje me LOT 21 - Niveli 2

Të dhënat e publikuara me njësitë e brendshme të jetës reale



HXYS - AV1 / AY1



RXYSA-AV1



RXYSA-AY1

Njësi e jashtme		RXYSA	4AV1	5AV1	6AV1	4AY1	5AY1	6AY1	
Gama e kapacitetit		HP	4	5	6	4	5	6	
Kapaciteti ftohës	Prated,c	kW	12.1	14.0	15.5	12.1	14.0	15.5	
Kapaciteti i ngrohjes	Prated,h	kW	12.1	14.0	15.5	12.1	14.0	15.5	
	Max. 6°CWB	kW	14.2	16.0	18.0	14.2	16.0	18.0	
Kombinimi i rekomanduar			3xFXSA25A2VEB+ 1xFXSA32A2VEB	4xFXSA32A2VEB	2xFXSA32A2VEB+ 2xFXSA40A2VEB	3xFXSA25A2VEB+ 1xFXSA32A2VEB	4xFXSA32A2VEB	2xFXSA32A2VEB+ 2xFXSA40A2VEB	
ηs,c		%	324.5	306.1	301.0	312.5	294.8	289.9	
ηs,h		%	200.5	185.7	183.6	193.1	178.8	176.8	
SEER			8.2	7.7	7.6	7.9	7.4	7.3	
SCOP			5.1	4.7		4.9		4.5	
Numri maksimal i njësive të brendshme të lidhura			13 (1)	16 (1)	18 (1)	13 (1)	16 (1)	18 (1)	
Lidhja e indeksit të brendshëm	Min.		50.0	62.5	70.0	50.0	62.5	70.0	
	Nom.		100	125	140	100	125	140	
	Max.		130.0	162.5	182.0	130.0	162.5	182.0	
Dimensione	Njësia	LartësiaxGjerësiaxThellësia	mm		869x1,100x460				
Pesha	Njësia		kg		102				
Niveli i fuqisë së zërit	Ftohja	Nom.	dB(A)	67.0	68.1	69.0	67.0	68.1	69.0
	Ngrohje	Prated,h	dB(A)	69.0	70.0	71.0	69.0	70.0	71.0
Presioni i zërit	Ftohja	Nom. level	dB(A)	49.0	51.0		49.0	51.0	
Gama e funksionimit	Ftohja	Min.~Max.	°CDB		-5~46				
	Ngrohje	Min.~Max.	°CWB		-20~16				
Ftohës	Lloji/GWP				R-32/675.0				
	Ngarkimi				3.40 / 2.30				
Lidhjet e tubacioneve	E lëngshme	OD	mm		10				
			mm		15.9				
	Gaz	Sistemi	Aktual	m		300			
Furnizimi me energji elektrike	Faza/Frekuenca/Tensioni		Hz/V		1~/50/220-240		3N~/50/380-415		
Rryma - 50Hz	Amplifikatorët maksimalë të siguresave(MFA)		A		32		16		

VRV - Daikin RXYSQ-TV9 / TY9 / TY1

RXYSQ-TV9 / TY9 / TY1

Pompë nxehtësie e serisë VRV IV S

Zgjidhje për kursimin e hapësirës pa kompromentuar efikasitetin



 BY DAIKIN

Për njësitë e prodhuara dhe të shitura në Evropë*

 Tashmë plotësisht në përputhje me LOT 21 - Niveli 2
 Të dhënat e publikuara me njësitë e brendshme të jetës reale

RXYSQ-TV9



RXYSQ-TY9



RXYSQ -TY1

Njësi e jashtme		RXYSQ	4TV9	5TV9	6TV9	4TY9	5TY9	6TY9	8TY1	10TY1	12TY1	
Gama e kapacitetit		HP	4	5	6	4	5	6	8	10	12	
Kapaciteti ftohës	Prated,c	kW	12.1	14.0	15.5	12.1	14.0	15.5	22.4	28.0	33.5	
	Prated,h	kW	12.1	14.0	15.5	12.1	14.0	15.5	22.4	28.0	33.5	
Kapaciteti i ngrohjes	Max.	kW	14.2	16.0	18.0	14.2	16.0	18.0	25.0	31.5	37.5	
	6°CWB	kW	14.2	16.0	18.0	14.2	16.0	18.0	25.0	31.5	37.5	
Kombinimi i rekomanduar			3xRXYSQ25A2VE B+1xRXYSQ32A2 VEB	4xRXYSQ32A2VE B	2xRXYSQ32A2VE EB	3xRXYSQ25A2VE VEB	2xRXYSQ32A2VE VEB	2xRXYSQ32A2VE VEB	4xRXYSQ40A2 VEB	4xRXYSQ50P7VE B	6xRXYSQ50P7VE B	
η _{s,c}	%		278.9	270.1	278.0	269.2	260.5	268.3	247.3	247.4	256.5	
η _{s,h}	%		171.6	182.9	192.8	154.4	164.5	174.1	165.8	162.4	169.6	
SEER			7.0	6.8	7.0	6.8	6.6	6.8	6.3		6.5	
SCOP			4.4	4.6	4.9	3.9	4.2	4.4	4.2	4.1	4.3	
Numri maksimal i njësjëve të brendshme të lidhura			64 (1)									
Lidhja e indeksit të brendshëm	Min.		50.0	62.5	70.0	50.0	62.5	70.0	100.0	125.0	150.0	
	Max.		130.0	162.5	182.0	130.0	162.5	182.0	260.0	325.0	390.0	
Dimensione	Njesi	Lartësi	Gjerësi			Thellësi						
			mm			1,345x900x320		1,430x940x320		1,615x940x460		
Pesha	Njësia		kg		104							
Niveli i fuqisë së zërit	Ftohja	Nom.	dB(A)	68.0	69.0	70.0	68.0	69.0	70.0	73.0	74.0	76.0
	Ngrohje	Prated,h	dB(A)	68.0	69.0	70.0	68.0	69.0	70.0	73.0	74.0	76.0
Presioni i zërit	Ftohja	Nom.	dB(A)	50.0	51.0	50.0	50.0	51.0	55.0	55.0	57.0	
Gama e funksionimit	Ftohja	Min.~Max.	°CDB	-5.0 ~46.0				-5.0 ~ 52.0				
	Ngrohje	Min.~Max.	°CWB					-20.0 ~ 15.5				
Ftohës	Lloji/GWP						R- 410A/ 2,087.5					
	Ngarkimi						3/6 / 7.5		5.5/11.5		7.0/14.6	8.0/16.7
Lidhjet e tubacioneve	E lëngshme	OD	mm					10				13
	Gaz	OD	mm	15.9		19.1	15.9		19.1	22.2	25.4	
	Sistemi Aktual		m					300				
Furnizimi me energji elektrike			Hz/V	1N~/50/220-240				3N~/50/380-415				
Faza/Frekuenca/Tensioni												
Rryma - 50Hz	Amplifikatorët maksimalë të siguresave(MFA)		A	32				16		25		32

Panele Diellore

Ngrohje & Ftohje

Hidraulike

Hidrosanitare

Aksesore të ndryshëm

VRV - Daikin RXYSCQ-TV1
RXYSCQ-TV1
Kompakt i serisë VRV IV Spompë nxehtësie
VRV më kompakte

Tashmë plotësisht në përputhje me LOT 21 - Nivel 2
 Të dhënat e publikuara me njësitë e brendshme të jetës reale



RXYSCQ-TV1



RXYSCQ - TV1

Njësi e jashtme		RXYSCQ	4TV1	5TV1	6TV1	
Gama e kapacitetit		HP	4	5	6	
Kapaciteti ftohës	Prated,c	kW	12.1	14.0	15.5	
Kapaciteti i ngrohjes	Prated,h	kW	12.1	14.0	15.5	
	Max. \square° CWB	kW	14.2	16.0	18.0	
Kombinimi i rekomanduar			3xFXSQ25A2VEB + 1xFXSQ32A2VEB	4xFXSQ32A2VEB	2xFXSQ32A2VEB+ 2xFXSQ40A2VEB	
$\eta_{s,c}$	%		322.8	303.4	281.3	
$\eta_{s,h}$	%		182.3	185.1	186.0	
SEER			8.1	7.7	7.1	
SCOP			4.6		4.7	
Numri maksimal i njësive të brendshme të lidhura				64 (1)		
Lidhja e indeksit të brendshëm	Min.		50.0	62.5	70.0	
	Max.		130.0	162.5	182.0	
Dimensione	Njësi	LartësiaxGjerësiaxThellësia	mm	823x940x460		
Pesha	Njësi		kg	89		
Niveli i fuqisë së zërit	Ftohje	Nom.	dBA	68.0	69.0	70.0
	Ngrohje	Prated,h	dBA	69.0	70.0	71.0
Presioni i zërit	Ftohja	Nom.Niveli	dBA	51.0	52.0	53.0
Gama e funksionimit	Ftohja	Min.~Max.	$^{\circ}$ CDB	-5.0~46.0		
	Ngrohje	Min.~Max.	$^{\circ}$ CWB	-20.0~15.5		
Ftohës	Lloji/GWP			R-410A/2,087.5		
	Ngarkimi			3.7/7.7		
Lidhjet e tubacioneve të lëngshme	OD		mm	10		
	Gaz	OD	mm	15.9	19.1	
	Totali gjatësia e tubacionit	Sistem Aktual	m	300		
Furnizimi me energji elektrike		Faza/Frekuenca/Tensioni	Hz/V	1~/50 / 220-240		
Rryma - 50Hz	Amplifikatorët maksimalë të siguresave (MFA)		A	32		

RWEYQ-T9

Seria VRV IV me ftohje me ujë

Ideale për ndërtesa të larta, duke përdorur ujin si burim nxehtësie



RWEYQ-T9



 BY DAIKIN
 For units made and sold in Europe*

RWEYQ-T9

Njësia e jashtme		RWEYQ	8T9	10T9	12T9	14T9
Gama e kapacitetit		HP	8	10	12	14
Kapaciteti ftohës Prated,c		kW	22.4	28.0	33.5	40.0
Kapaciteti i ngrohjes	Prated,h	kW	25.0	31.5	37.5	45.0
	Max. 6°CWB	kW	25.0	31.5	37.5	45.0
Kombinimi i rekomanduar			4x FXMQ50P7VEB	4x FXMQ63P7VEB	6x FXMQ50P7VEB	1x FXMQ50P7VEB + 5x FXMQ63P7VEB
ηs,c	%		326.8	307.8	359.0	330.7
ηs,h	%		524.3	465.9	436.0	397.1
SEER			8.4	7.9	9.2	8.5
SCOP			13.3	11.8	11.1	10.1
Numri maksimal i njësive të brendshme të lidhura				64 (1)		
Lidhja e brendshme e indeksit	Min.		100.0	125.0	150.0	175.0
	Max.		300.0	375.0	450.0	525.0
Dimensionet	Njësia	Lartësi x Gjerësi x Thellësia			980x767x560	
Pesha	Njësia			195		197
Niveli i fuqisë së zërit	Ftohje	Nom.				
			dBA	65.0	71.0	72.0
Niveli i fuqisë së zërit	Ftohje	Nom.				
			dB	48.0	50.0	56.0
Gama e funksionimit	Uji i hyrjes	Ftohje Min.~Max.			10~45	
	Temperatura Heating	Min.~Max.	°CWB		10~45	
	Temperatura Max.		°CDB		40	
	Lagështia	Ftohje~ Max.	%		80~80	
Ftohësi	Heating	Ngrohje				
	Iloji/GWP				R-410A/2,087.5	
Piping connections Liquid	Ngarkimi		kg/TCO2Eq	7.9/16.5		9.6/20.0
	OD		mm	9.52		12.7
Piping connections Gas	Gaz	OD	mm	19.1	22.2	28.6
	HP/LP gaz	OD	mm	15.9/19.1	19.1/22.2	19.1/28.6
	Drain	Size			14mm OD/ 10mm ID	22.2/28.6
	Uje	Inlet/Outlet Size			ISO 228-G1 1/4 B/ISO 228-G1 1/4 B	
Sistemi total i tubacioneve		Actual	m		500	
Gjatësia						
Furnizimi e. elektrike	Faza / Frekuenca / Tensioni		Hz/V		3N~/50/380-415	
Rryma - 50Hz - 50Hz	Amplifikatorët maksimal të siguresave (MFA)		A	20		25

Panele Diellore

Ngrohje & Ftohje

Hidraulike

Hidrosanitare

Aksesore të ndryshëm

RXYLQ-T

Pompë nxehtësie VRV IV, e optimizuar për ngrohje

Aty ku ngrohja është prioritet pa kompromentuar efikasitetin



Për njësitë e prodhuara dhe të shitura në Evropë*



RXYLQ1628T

Njësi e jashtme	RXYLQ	10T	12T	14T
Gama e kapacitetit	HP	10	12	14
Kapaciteti ftohës	Prated,c kW	28.0	33.5	40.0
Kapaciteti i ngrohjes	Prated,h kW	31.5	37.5	45.0
	Max. 6°CWB kW	31.5	37.5	45.0
Kombinimi i rekomanduar		4x FXMQ63P7VEB	6x FXMQ50P7VEB	1x FXMQ50P7VEB + 5x FXMQ63P7VEB
ηs,h	%	251.4	274.4	270.1
ηs,h	%	144.3	137.6	137.1
SEER		6.4	6.9	6.8
SCOP		3.7		3.5
Numri maksimal i njësite të brendshme të lidhura			64 (1)	
Lidhja e indeksit të brendshëm	Min. Nom. Max.	175 250 325	210 300 390	245 350 455
Dimensionet	Unit LartësiaxGjerësiaxThellësia	mm	1,685x1,240x765	
Pesha	Unit	kg	302	
Niveli i fuqisë së zërit	Ftohja Nom.	dBa	77.0	81.0
Niveli i presionit të zërit	Ftohja Nom.	dBa	56.0	59.0
Gama e funksionimit	Ftohja Min.~Max. Ngrohje Min.~Max.	°CDB °CWB	-5 ~43 -25 ~16	
Ftohës	Lloji/GWP		R-410A/2,087.5	
	Ngarkimi	kg/TCO2Eq	11.8/24.6	
Lidhjet e tubacioneve të lëngshme	OD	mm	9.52	12.7
	Gaz OD	mm	22.2	28.6
	Sistemi total i tubacioneve Gjatësia aktuale	m	500	
Furnizimi me energji elektrik Faza/Frekuenca/Tensioni		Hz/V	3N~/50/380-415	
Aktuale- 50Hz	Amplifikatorët maksimalë të siguresave (MFA)	A	25	32

Sistemi i njësisë së jashtme	RXYLQ	16T	18T	20T	22T	24T	26T	28T
Sistemi	Moduli i njësisë së jashtme 1 Moduli i njësisë së jashtme 2	RXMLQ8T		RXYLQ10T		RXYLQ12T	RXYLQ14T	RXYLQ14T
Gama e kapacitetit		HP	16	18	20	22	24	26
Kapaciteti ftohës	Prated,c kW	44.8	50.4	56.0	61.5	67.0	73.5	80.0
Kapaciteti i ngrohjes	Prated,h kW	50.0	56.5	63.0	69.0	75.0	82.5	90.0
	Max. 6°CWB kW	50.0	56.5	63.0	69.0	75.0	82.5	90.0
Kombinimi i rekomanduar		4x FXMQ63P7VEB +2x FXMQ80P7VEB	3x FXMQ50P7VEB +5x FXMQ63P7VEB	2x FXMQ50P7VEB +6x FXMQ63P7VEB	6x FXMQ50P7VEB +4x FXMQ63P7VEB	4x FXMQ50P7VEB +4x FXMQ63P7VEB +2x FXMQ80P7VEB	7x FXMQ50P7VEB +5x FXMQ63P7VEB	6x FXMQ50P7VEB +4x FXMQ63P7VEB +2x FXMQ80P7VEB
ηs,c		261.8	255.7	251.4	263.0	274.4	270.8	270.1
%								
ηs,h		138.0	140.5	144.3	140.3	137.6		137.1
%								
SEER		6.6	6.5	6.4	6.6	6.9		6.8
SCOP		3.5	3.6	3.7	3.6		3.5	
Numri maksimal i njësite të brendshme të lidhura					64 (1)			
Lidhja e indeksit të brendshëm	Min. Nom. Max.	280 400 520	315 450 585	350 500 650	385 550 715	420 600 780	455 650 845	490 700 910
Lidhjet e tubacioneve të lëngshme	OD	mm	12.7		15.9			19.1
	Gaz OD	mm		28.6			34.9	
	Sistemi total i tubacioneve Gjatësia aktuale	m			500			
Aktuale- 50Hz	Amplifikatorët maksimalë të siguresave (MFA)	A	40	45	50		60	

RXYLQ-T

Pompë nxehtësie VRV IV, e optimizuar për ngrohje

Aty ku ngrohja është prioritet pa kompromentuar efikasitetin



Për njësitë e prodhuara dhe të shitura në Evropë*



RXYLQ-T

VRV IV C⁺ series

RXYLQ1628T

Sistemi i njësisë së jashtme		RXYLQ	30T	32T	34T	36T	38T	40T	42T	
Sistemi	Moduli i njësisë së jashtme 1	RXYLQ10T								
	Moduli i njësisë së jashtme 2	RXYLQ12T								
	Moduli i njësisë së jashtme 3	RXYLQ14T								
Gama e kapacitetit	HP	30	32	34	36	38	40	42		
Kapaciteti ftohës	Pratedh	kW	84.0	89.5	95.0	100.5	107.0	113.5	120.0	
	Kapaciteti i ngrohjes	Pratedh	kW	94.5	101	107	113	120	128	135
		Max.	6°CWB	kW	94.5	100.5	106.5	112.5	120.0	127.5
Kombinimi i rekomanduar			9xFXMQ50P7VEB +5xFXMQ63P7VEB	8xFXMQ63P7VEB +4xFXMQ80P7VEB	3xFXMQ50P7VEB+ +2xFXMQ80P7VEB	2xFXMQ50P7VEB +10x FXMQ63P7VEB+ 2xFXMQ80P7VEB	6xFXMQ50P7VEB +10xFXMQ63P7VEB	9xFXMQ50P7VEB +9xFXMQ63P7VEB	12xFXMQ63P7VEB+ 4xFXMQ80P7VEB	
ηsc	%	2514	2591	266.8	2744	2716	2703	2701		
ηsh	%	144.3	1416	139.2	1396		1391			
SEER		6.4	6.6	6.7		6.9		6.8		
SCOP		37		36			35			
Numri maksimal i njësisë të brendshme të lidhura					64(1)					
Lidhja e indeksit të brendshëm	Min.		525	560	595	630	665	700	735	
	Nom.		750	800	850	900	950	1000	1050	
	Max.		975	1040	1105	1170	1235	1300	1365	
Lidhjet e tubacioneve të lëngshme	OD	mm		349		391		413		
	Gaz	OD	mm							
	Sistemi total	Gjatësia aktuale e tubadonit	m				500			
Aktuale - 50Hz	Amplifikatorët maksimalë të siguresave (MFA)	A			80			90		

Moduli i njësisë së jashtme		RXMLQ	8T	
Dimensionet	Njësia	LartësiaxGjerësiaxThellësia	mm	1,685x1,240x765
Pesha	Njësia		kg	302
Fan	Presioni statik i jashtëm	Max.	Pa	78
Niveli i fuqisë së zërit	Ftohja	Nom.	dB(A)	75.0
Niveli i presionit të zërit	Ftohja	Nom.	dB(A)	55.0
Gama e funksionimit	Ftohja	Min.~Max.	°CDB	-5 ~43
		Ngrohje	Min.~Max.	°CWB
Ftohës	Lloji/GWP			R-410A/2,087.5
		Ngarkimi	kg/TCO2Eq	11.8/24.6
Furnizimi me energji elektrike	Faza/Frekuenca/Tensioni		Hz/V	3N~/50/380-415
Aktuale - 50Hz	Amplifikatorët maksimalë të siguresave (MFA)	A		20

Panele Diellore

Ngrohje & Ftohje

Hidraulike

Hidrosanitare

Aksesore të ndryshëm

SB.RKXYQ-T(8)

Pompë nxehtësie VRV IV për instalim të brendshëm

VRV e padukshme



Për njësitë e prodhuara dhe të shitura në Evropë*



Tashmë plotësisht në përputhje me LOT 21 - Niveli 2

Të dhënat e publikuara me njësitë e brendshme të jetës reale



SB.RKXYQ-T



SB.RKXYQ-T



SB.RKXYQ-T8

Sistemi i njësisë së jashtme		SB.RKXYQ		5T8		8T	
Sistemi	Njësia e shkëmbyesit të nxehtësisë			RDXYQ5T8		RDXYQ8T	
	Njësia e kompresorit			RKXYQ5T8		RKXYQ8T	
Gama e kapacitetit		HP			5		8
Kapaciteti ftohës	Prated,c		kW	14.0		22.4	
Kapaciteti i ngrohjes	Prated,h		kW	10.4		12.9	
	Max.	6°CWB	kW	16.0		25.0	
Kombinimi i rekomanduar			4x FXSQ32A2VEB		4x FXMQ50P7VEB		
η _{s,c}		%	200.1		191.1		
η _{s,h}		%	149.3		140.9		
SEER			5.1		4.9		
SCOP			3.8		3.6		
Numri maksimal i njësive të brendshme të lidhura			10(1)		17(1)		
Lidhja e indeksit të brendshëm	Min.			62.5		100.0	
	Max.			162.5		260.0	
Lidhjet e tubacioneve të gjatshme	Nëndërmjet modulit të kompresorit e (CM) dhe moduli i shkëmbyesit të nxehtësisë (HM)	Gaz	OD	mm	12.7		
					19.1	22.2	
	Nëndërmjet modulit të kompresorit (CM) dhe njësitë e brendshme (IU) dhe njësitë e brendshme (IU)	Gaz	OD	mm	9.52		
					15.9	19.1	
Gjatësia totale e tubacionit	Sistemi	Actual	m	140		300	

Moduli i njësitë së jashtme		Moduli i shkëmbyesit të nxehtësisë - RDXYQ				Compressor module - RKXYQ			
		5T8		8T		5T8		8T	
Dimensioni	Njësia	Height	Width	Depth	mm	397x1,456x1,044		701x600x554	
Pesha	Njësia		kg	95		103		79	
Niveli i fuqisë së zërit Ftohja	Nom.		dBA	77.0		81.0		60.0	
Niveli i presionit të zërit Ftohja	Nom.		dBA	47.0		54.0		47.0	
Ftohës	Lloji/GWP			R-410A/-		R-410A/2,087.5			
	Ngarkimi		kg/CO ₂ Eq	-/		2.00/4.20		4.00/8.35	
Furnizimi me energji elektrike	Faza/Frekuenca/Tensioni		Hz/V	1N~/50/220-240		3N~/50/380-415			
Aktuale -50Hz	Amplifikatorët maksimalë të siguresave (MFA)		A	10		16		20	



VRV - Daikin RXYQQ-U

RXYQQ-U

Zëvendësim VRV, pompë nxehtësie



Për njësitë e prodhuara dhe të shitura në Evropë*



RXYQQ-U



RXYQQ-U

Sistemi i njësive të jashtme	RXYQQ	22U	24U	26U	28U	30U	32U	34U	36U	38U	40U	42U	
System	Moduli i njësive të jashtme 1	RXYQQ10U	RXYQQ8U	RXYQQ12U			RXYQQ16U			RXYQQ8U	RXYQQ10U		
	Moduli i njësive të jashtme 2	RXYQQ12U	RXYQQ16U	RXYQQ14U	RXYQQ16U	RXYQQ18U	RXYQQ16U	RXYQQ18U	RXYQQ20U	RXYQQ10U	RXYQQ12U	RXYQQ16U	
	Moduli i njësive të jashtme 3					-				RXYQQ20U	RXYQQ18U	RXYQQ16U	
Gama e kapacitetit	HP	22	24	26	28	30	32	34	36	38	40	42	
Kapaciteti ftohës	Prated,c	kW	61.5	67.4	73.5	78.5	83.9	90.0	95.4	97.0	111.9	118.0	118.0
Kapaciteti i ngrohjes	Prated,h	kW	61.5	67.4	73.5	78.5	83.9	90.0	95.4	101.0	111.9	118.0	62.4
	Max. 6°CWB	kW	69.0	75.0	82.5	87.5	94.0	100.0	106.5	113.0	125.5	131.5	131.5
Kombinimi i rekomanduar		6xFXFQ50AVE	4xFXFQ50AVE	7xFXFQ50AVE	6xFXFQ50AVE	9xFXFQ50AVE	8xFXFQ63AVE	3xFXFQ50AVE	2xFXFQ50AVE	6xFXFQ50AVE	9xFXFQ50AVE	12xFXFQ63AV	
		B +4x	B +4x	B +5x	B +4x	B +5x	B +4x	B +9x	B +10x	B +10x	B +9x	EB +4x	
		FXFQ63AVEB	FXFQ63AVEB	FXFQ63AVEB	FXFQ63AVEB	FXFQ63AVEB	FXFQ80AVEB	FXFQ63AVEB	FXFQ63AVEB	FXFQ63AVEB	FXFQ63AVEB	FXFQ80AVEB	
			+2xFXFQ80AV		+2xFXFQ80AV			+2xFXFQ80AV	+2xFXFQ80AV				
			EB		EB			EB	EB				
ns,c	%	274.5	269.9	264.2	257.8	256.8	251.7	253.3	250.8	272.4	263.5	261.2	
ns,h	%	171.2	167.0	164.6	166.0	169.8	163.1	166.2	162.4	167.5	170.0	165.5	
SEER		6.9	6.8	6.7	6.5			6.4	6.3	6.9	6.7	6.6	
SCOP		4.4	4.3	4.2			4.3	4.2	4.1	4.3	4.3	4.2	
Numri maksimal i njësive të brendshme të lidhura		64 (1)											
Lidhja e indeksit të brendshëm	Min.	275.0	300.0	325.0	350.0	375.0	400.0	425.0	450.0	475.0	500.0	525.0	
	Max.	715.0	780.0	845.0	910.0	975.0	1,040.0	1,105.0	1,170.0	1,235.0	1,300.0	1,365.0	
Lidhjet e tubacioneve	E lëngshme	OD	mm			15.9	mm			19.1	mm		41.3
	Gaz	OD	mm			28.6	mm			34.9	mm		41.3
	Sistemi total i tubacioneve aktualë	Gjatësia	m				m			300	m		
Furnizimi me energji elektrike	Faza/Frekuenca/Tensioni	Hz/V	3N~/50/380-415										
Aktuale - 50Hz	Amplifikatorët maksimalë të siguresave (MFA)	A	63						80	100			

Panele Diellore

Ngrohje & Ftohje

Hidraulike

Hidrosanitare

Aksesore të ndryshëm

REYQ-U

VRV IV+rikuperimi i nxehtësisë

Efikasiteti më i mirë & zgjidhje komforti



Për njësitë e prodhuara dhe të shitura në Evropë*



REYQ10,13,16,18,20,22U

Njësi e jashtme	REYQ	8U	10U	12U	14U	16U	18U	20U		
Gama e kapacitetit	HP	8	10	12	14	16	18	20		
Kapaciteti ftohës	Prated,c	kW	22.4	28.0	33.5	40.0	45.0	52.0		
Kapaciteti i ngrohjes	Prated,h	kW	22.4	28.0	33.5	40.0	45.0	56.0		
	Max. 6°CWB	kW	25.0	31.5	37.5	45.0	50.0	63.0		
Kombinimi i rekomanduar		4x FXFQ50AVEB	4x FXFQ63AVEB	6x FXFQ50AVEB	1x FXFQ50AVEB + 5x FXFQ63AVEB	4x FXFQ63AVEB + 2x FXFQ80AVEB	3x FXFQ50AVEB + 5x FXFQ63AVEB	2x FXFQ50AVEB + 6x FXFQ63AVEB		
ηs,c	%	286.1	264.8	257.0	255.8	243.1	250.6	246.7		
ηs,h	%	165.1	169.7	183.8	168.3	172.5	172.5	162.7		
SEER		7.2	6.7	6.5	6.5	6.2	6.3	6.2		
SCOP		4.2	4.3	4.7	4.3	4.4	4.4	4.1		
Numri maksimal i njësjve të brendshme të lidhura										
Lidhja e indeksit të brendshëm	Min.	100.0	125.0	150.0	175.0	200.0	225.0	250.0		
	Nom.									
	Max.	260.0	325.0	390.0	455.0	520.0	585.0	650.0		
Dimensione	Njësia	Lartësi	Gjerësi	Thellësia						
		mm	1,685x930x765			1,685x1,240x765				
Pesha	Njësia	kg		230	314		317			
Niveli i fuqisë së zërit	Ftohja	Nom.	dBA	78.0	79.1	83.4	80.9	85.6	83.8	87.9
	Ngrohje	Prated,h	dBA	79.6	80.9	83.5	83.9	86.9	85.3	89.8
Presioni i zërit	Ftohja	Nom. level	dBA	57.0	61.0	60.0	63.0	62.0	65.0	
Gama e funksionimit	Ftohja	Min.~Max.	°CDB						-5.0 ~43.0	
	Ngrohje	Min.~Max.	°CWB						-20.0 ~15.5	
Ftohës	Lloji/GWP							R-410A/2,087.5		
	Ngarkimi	kg/TCO2Eq	9.7/20.2	9.8/20.5	9.9/20.7				11.8/24.6	
Lidhjet e tubacioneve	E lëngshme	OD	mm	9.52				12.7	15.9	
	Gaz	OD	mm	19.1	22.2				28.6	
	HP/LP	OD	mm	15.9	19.1				22.2	
	gaz									
	Sistemi total i tubacioneve Gjatësia aktuale	m						1,000		
Furnizimi me energji elektrike	Faza/Frekuenca/Tensioni	Hz/V							3N~/50/380-415	
Aktuale -50Hz Amplifikatorët maksimalë të siguresave (MFA)	A	20	25				32	40	50	

Sistemi i njësjve të jashtme	REYQ	10U	13U	16U	18U	20U	22U	24U	26U	28U	30U	32U	
Sistemi	Moduli i njësjve të jashtme 1	REMQ5U			REYQ8U			REYQ10U		REYQ8U		REYQ12U	
	Moduli i njësjve të jashtme 2	REMQ5U		REYQ8U		REYQ10U		REYQ12U		REYQ16U		REYQ18U	
Gama e kapacitetit	HP	10	13	16	18	20	22	24	26	28	30	32	
Kapaciteti ftohës	Prated,c	kW	28.0	36.4	44.8	50.4	55.9	61.5	67.4	73.5	78.5	83.9	
Kapaciteti i ngrohjes	Prated,h	kW	28.0	36.4	44.8	50.4	55.9	61.5	67.4	73.5	78.5	83.9	
	Max. 6°CWB	kW	32.0	41.0	50.0	56.5	62.5	69.0	75.0	82.5	87.5	100.0	
Kombinimi i rekomanduar		4x	3x FXFQ50AVE	4x FXFQ63AVE	4x FXFQ50AVE	10x FXFQ50AVE	6x FXFQ50AVE	4x FXFQ50AVE	7x FXFQ50AVE	6x FXFQ50AVE	9x FXFQ50AVE	8x FXFQ63AVE	
			FXFQ63AVEB	B +3x	B +2x	B +4x	B	B +4x	B +4x	B +5x	B +4x	B +5x	
			FXFQ63AVEB	FXFQ80AVEB	FXFQ63AVEB		FXFQ63AVEB	FXFQ63AVEB	FXFQ63AVEB	FXFQ63AVEB	FXFQ63AVEB	FXFQ80AVEB	
							+2x	+2x					
							FXFQ80AVEB	FXFQ80AVEB					
ηs,c	%	275.1	301.3	288.6	272.9	266.0	260.4	257.7	257.5	251.9	266.8	243.1	
ηs,h	%	158.8	160.6	168.2	167.9	175.7	178.5	167.6	175.5	174.8	179.4	169.1	
SEER		7.0	7.6	7.3	6.9	6.7	6.6	6.5	6.5	6.4	6.7	6.2	
SCOP		4.0	4.1	4.3	4.5	4.5	4.3	4.5	4.4	4.4	4.6	4.3	
Numri maksimal i njësjve të brendshme të lidhura													
Lidhja e indeksit të brendshëm	Min.	125.0	163.0	200.0	225.0	250.0	275.0	300.0	325.0	350.0	375.0	400.0	
	Nom.												
	Max.	325.0	423.0	520.0	585.0	650.0	715.0	780.0	845.0	910.0	975.0	1,040.0	
Lidhjet e tubacioneve	E lëngshme	OD	mm	9.52	12.7			15.9					
	Gaz	OD	mm	22.2			28.6						
	HP/LP	OD	mm	19.1	22.2				28.6				
	gaz												
	Sistemi total i tubacioneve Gjatësia aktuale	m	500								1,000		
Furnizimi me energji elektrike	Faza/Frekuenca/Tensioni	Hz/V										3N~/50/380-415	
Aktuale -50Hz Amplifikatorët maksimalë të siguresave (MFA)	A	40				50				63	80		



VRV - Daikin REYQ-U

REYQ-U

VRV IV+ rikuperimi i nxehtësisë

Efikasiteti më i mirë & zgjidhje komforti



Për njësitë e prodhuara dhe të shitura në Evropë*



REYQU



REYQ10,13,16,18,20,22U

VRV IV+

Sistemi i njësisë së jashtme		REYQ	34U	36U	38U	40U	42U	44U	46U	48U	50U	52U	54U	
Sistemi	Moduli i njësisë së jashtme 1	REYQ16U												
	Moduli i njësisë së jashtme 2	REYQ18U		REYQ20U		REYQ12U		REYQ14U		REYQ16U		REYQ18U		
	Moduli i njësisë së jashtme 3	REYQ18U												
Gama e kapacitetit	HP	34	36	38	40	42	44	46	48	50	52	54		
Kapaciteti ftohës	Prated,c	kW	95.4	97.0	106.3	111.9	118.0	123.5	130.0	135.0	140.4	145.8	151.2	
Kapaciteti i ngrohjes	Prated,h	kW	95.4	101.0	106.4	111.9	118.0	123.5	130.0	135.0	140.4	145.8	151.2	
	Max. 6°CWB	kW	106.5	113.0	119.0	125.5	131.5	137.5	145.0	150.0	156.5	163.0	169.5	
Kombinimi i rekomanduar		3x	2x	6x	9x	12x	6x	1x	12x	3x	6x	9x		
		FXFQ50AVEB	FXFQ50AVEB	FXFQ50AVEB + FXFQ50AVEB + FXFQ63AVEB	FXFQ50AVEB + FXFQ63AVEB	FXFQ50AVEB + FXFQ63AVEB	FXFQ50AVEB + FXFQ63AVEB	FXFQ50AVEB + FXFQ63AVEB	FXFQ63AVEB	FXFQ50AVEB	FXFQ50AVEB + FXFQ50AVEB	FXFQ50AVEB + FXFQ50AVEB		
		+	+	10x	9x	+	8x	+	+6x	+	14x	+15x		
		9x	10x	FXFQ63AVEB	FXFQ63AVEB	FXFQ80AVEB	FXFQ63AVEB + 13x	FXFQ80AVEB	13x	FXFQ63AVEB + 2x	FXFQ63AVEB	FXFQ63AVEB	FXFQ63AVEB	
		FXFQ63AVEB + FXFQ63AVEB					4x	FXFQ63AVEB +		FXFQ63AVEB + 2x				
		2x	+ 2x					FXFQ80AVEB	4x	4x	FXFQ80AVEB			
		FXFQ80AVEB	FXFQ80AVEB					FXFQ80AVEB		FXFQ80AVEB				
ηs,c	%	259.2	255.3	269.2	259.6	250.2	249.3	246.8	243.1	254.4	265.7	275.2		
ηs,h	%	172.0	166.3	176.0	176.1	167.8	171.9	168.8	168.5	170.3	171.7	173.3		
SEER		6.6	6.5	6.8	6.6		6.3		6.2	6.4	6.7	7.0		
SCOP		4.4	4.2		4.5	4.3	4.4		4.3		4.4			
Numri maksimal i njësive të brendshme të lidhura		64 (1)												
Lidhja e indeksit të brendshëm	Min.	425.0	450.0	475.0	500.0	525.0	550.0	575.0	600.0	625.0	650.0	675.0		
	Nom.													
	Max.	1,105.0	1,170.0	1,235.0	1,300.0	1,365.0	1,430.0	1,495.0	1,560.0	1,625.0	1,690.0	1,755.0		
Lidhjet e tubacioneve	E lëngshme OD	mm	19.1											
	Gaz OD	mm	34.9	41.3										
	HP/LP gaz OD	mm	28.6											
	Sistemi total i tubacioneve Gjatësia aktuale	m	1,000											
	Furnizimi me energji elektrike Faza/Frekuenca/Tensioni	Hz/V	3N~/50/380-415											
Aktuale -50Hz Amplifikatorët maksimalë të siguresave (MFA)	A	80										125		

Moduli i njësive së jashtme		REMQ	SU
Dimensioni	Njësia LartësiaxGjerësiaxThellësia	mm	1,685x930x765
Pesha	Njësia	kg	230
Fan	Statike e jashtme Max. presioni	Pa	78
Niveli i fuqisë së zërit	Ftohja Nom.	dB(A)	78.0
Niveli i presionit të zërit	Ftohja Nom.	dB(A)	57.0
Gama e funksionimit	Ftohja Min.~Max.	°CDB	-5.0~43.0
	Ngrohje Min.~Max.	°CWB	-20.0~15.5
Ftohës	Lloji/GWP		R-410A/2,087.5
	Ngarkimi	kg/TCO2Eq	9.7/20.2
Furnizimi me energji elektrike	Faza/Frekuenca/Tensioni	Hz/V	3N~/50/380-415
Aktuale -50Hz	Amplifikatorët maksimalë të siguresave(MFA)	A	20

Panele Djellore

Ngrohje & Ftohje

Hidraulike

Hidrosanitare

Aksesore të ndryshëm

RYYQ-U* /RXYQ-U*



VRRV IV+ Pompat e nxehtësisë

Zgjidhja optimale e Daikin me komoditet të lartë



RYYQ



RXYQ

LOOP
 BY DAIKIN
 Për njësitë e prodhuara dhe të shitura në Evropë*

VRRV IV+

Outdoor unit		RYYQ/RXYQ	8U*	10U*	12U*	14U*	16U*	18U*	20U*
Gama e kapacitetit	HP		8	10	12	14	16	18	20
Kapaciteti ftohës Prated,c	kW		22.4	28.0	33.5	40.0	45.0	50.4	52.0
Kapaciteti i ngrohjes	Prated,h	kW	22.4	28.0	33.5	40.0	45.0	50.4	56.0
	Max. 6°CWB	kW	25.0	31.5	37.5	45.0	50.0	56.5	63.0
Kombinimi i rekomanduar			4x FXFQ50AVEB	4x FXFQ63AVEB	6x FXFQ50AVEB	1x FXFQ50AVEB + 5x FXFQ63AVEB	4x FXFQ63AVEB + 2x FXFQ80AVEB	3x FXFQ50AVEB + 5x FXFQ63AVEB	2x FXFQ50AVEB + 6x FXFQ63AVEB
ηs,c	%		302.4	267.6	247.8	250.7	236.5	238.3	233.7
ηs,h	%		167.9	168.2	161.4	155.4	157.8	163.1	156.6
SEER			7.6	6.8		6.3		6.0	5.9
SCOP			4.3		4.1		4.0		4.0
Numri maksimal i njësive të brendshme të lidhura						64 (1)			
Lidhja e brendshme e indeksit	Min.		100.0	125.0	150.0	175.0	200.0	225.0	250.0
	Max.		260.0	325.0	390.0	455.0	520.0	585.0	650.0
Dimensions	Unit	HeightxWidthxDepth	mm			1,685x930x765			
Weight	Unit		kg			RYYQ: 252 / RXYQ: 201		RYYQ: 319 / RXYQ: 281	
Sound power level	Cooling Nom.	dBA	78.0	79.1	83.4	80.9	85.6	83.8	87.9
	Heating Prated,h	dBA	79.6	80.9	83.5	83.1	86.5	85.3	89.8
Sound pressure level Cooling	Nom.	dBA	57.0		61.0	60.0	63.0	62.0	65.0
Operation range	Cooling Min.~Max.	°CDB				-5.0 ~43.0			
	Heating Min.~Max.	°CWB				-20.0 ~15.5			
Refrigerant	Type/GWP		R-410A/2,087.5						
	Charge	kg/TCO2Eq	5.9/12.3	6.0/12.5	6.3/13.2	10.3/21.5	11.3/23.6	11.7/24.4	11.8/24.6
Lidhjet e tubacioneve	E lëngshme OD	mm	9.52			12.7		15.9	
	Gaz OD	mm	19.1	22.2					
	Sistemi total i tubacioneve Actual Gjatësia	m				1,000			
Furnizimi e.elektrike	Faza / Frekuenca / Tensioni	Hz/V	3N~/50/380-415						
Rryma -50Hz	Amplifikatorët max të siguresave (MFA)	A	20	25	32	40		50	

Sistemi i njësive së jashtme		RYYQ/RXYQ	22U*	24U*	26U*	28U*	30U*	32U*	34U*	36U*	38U*	
Sistemi	Moduli 1 i njësive së jashtme		10	8	12		16		16	8		
	Moduli 2 i njësive së jashtme		12	16	14	16	18	16	18	20	10	
	Moduli 3 i njësive së jashtme		20									
Gama e kapacitetit	HP		22	24	26	28	30	32	34	36	38	
Kapaciteti ftohës Prated,c	kW		61.5	67.4	73.5	78.5	83.9	90.0	95.4	97.0	102.4	
Kapaciteti i ngrohjes	Prated,h	kW	61.5	67.4	73.5	78.5	83.9	90.0	95.4	101.0	106.4	
	Max. 6°CWB	kW	69.0	75.0	82.5	87.5	94.0	100.0	106.5	113.0	119.5	
Kombinimi i rekomanduar			6x FXFQ50AVEB	4x FXFQ50AVEB + 4x FXFQ63AVEB	7x FXFQ50AVEB + 5x FXFQ63AVEB	6x FXFQ50AVEB + 4x FXFQ63AVEB	9x FXFQ50AVEB + 4x FXFQ63AVEB	8x FXFQ63AVEB + 4x FXFQ80AVEB	3x FXFQ50AVEB + 9x FXFQ63AVEB	2x FXFQ50AVEB + 10x FXFQ63AVEB	6x FXFQ50AVEB + 10x FXFQ63AVEB	
ηs,c	%		274.5	269.9	264.2	257.8	256.8	251.7	253.3	250.8	272.4	
ηs,h	%		171.2	167.0	164.6	166.0	169.8	163.1	166.2	162.4	167.5	
SEER			6.9	6.8	6.7		6.5		6.4	6.3	6.9	
SCOP			4.4	4.3		4.2		4.3	4.2		4.3	
Numri maksimal i njësive të brendshme të lidhura			64 (1)									
Lidhja e brendshme e indeksit	Min.		275.0	300.0	325.0	350.0	375.0	400.0	425.0	450.0	475.0	
	Nom.											
	Max.		715.0	780.0	845.0	910.0	975.0	1,040.0	1,105.0	1,170.0	1,235.0	
Lidhjet e tubacioneve	E lëngshme OD	mm	15.9									
	Gaz OD	mm	28.6					34.9	19.1		41.3	
	Sistemi total i tubacioneve Actual Gjatësia	m							1,000			
Furnizimi e.elektrike	Faza / Frekuenca / Tensioni	Hz/V	3N~/50/380-415									
Rryma -50Hz	Amplifikatorët max të siguresave (MFA)	A	63			80			100			



VRV - Daikin RYYQ/RXYQ

RYYQ-U* /RXYQ-U*

VRV IV+ Pompat e nxehtësisë

Zgjidhja optimale e Daikin me komoditet të lartë



 BY DAIKIN

 Për njësitë e
 prodhuara dhe të
 shitura në Evropë*

RYQ8-12U

VRV IV+

RYYQ



RXYQ

Sistemi i njësisë së jashtme	RYYQ/RXYQ	40U*	42U*	44U*	46U*	48U*	50U*	52U*	54U*	
Sistemi	Moduli i njësisë së jashtme 1	10		12	14		16		18	
	Moduli i njësisë së jashtme 2	12			16				18	
	Moduli i njësisë së jashtme 3	18			16			18		
Gama e kapacitetit	HP	40	42	44	46	48	50	52	54	
Kapaciteti ftohës	Prated,c	kW	111.9	118.0	123.5	130.0	135.0	140.4	145.8	151.2
Kapaciteti ftohës i ngrohjes	Prated,h	kW	111.9	118.0	123.5	130.0	135.0	140.4	145.8	151.2
	Max. 6°CWB	kW	125.5	131.5	137.5	145.0	150.0	156.5	163.0	169.5
Kombinimi i rekomanduar		9x FXFQ50AVEB +9x FXFQ63AVEB	12x FXFQ63AVEB +4x FXFQ80AVEB	6x FXFQ50AVEB +8x FXFQ63AVEB +4x FXFQ80AVEB	1x FXFQ50AVEB +13x FXFQ63AVEB +4x FXFQ80AVEB	12x FXFQ63AVEB +6x FXFQ80AVEB	3x FXFQ50AVEB +13x FXFQ63AVEB +4x FXFQ80AVEB	6x FXFQ50AVEB +14x FXFQ63AVEB +2x FXFQ80AVEB	9x FXFQ50AVEB +15x FXFQ63AVEB	
ηs,c	%	263.5	261.2	255.9	254.9	251.7	252.8	253.7	254.1	
ηs,h	%	170.0	165.5	164.5	162.0	162.8	165.2	167.2	169.4	
SEER		6.7	6.6	6.5			6.4			
SCOP		4.3		4.2		4.1	4.2		4.3	
Numri maksimal i njësisë të brendshme të lidhura					64 (1)					
Lidhja e indeksit të brendshëm	Min.	500.0	525.0	550.0	575.0	600.0	625.0	650.0	675.0	
	Max.	1,300.0	1,365.0	1,430.0	1,495.0	1,560.0	1,625.0	1,690.0	1,755.0	
Lidhjet e tubacioneve	E lëngshme	OD	mm			19.1				
	Gaz	OD	mm			41.3				
	Sistemi total i tubacioneve Gjatësia aktuale		m			1,000				
Furnizimi me energji elektrike	Faza/Frekuenca/Tensioni	Hz/V				3N~/50/380-415				
Aktuale-50Hz Amplifikatorët maksimalë të siguresave (MFA)		A		100				125		

Moduli i njësisë së jashtme	RYYQ	8U*	10U*	12U*	14U*	16U*	18U*	20U*	
Dimensione	Njësia LartësiAxGjerësiAxThellësia	mm	1,685x930x765			1,685x1,240x765			
Pesha	Njësia	kg	198			275			
Fan	Statike e jashtme Max. presioni	Pa				78			
Niveli i fuqisë së zërit	Ftohja Nom.	dBA	78.0	79.1	83.4	80.9	85.6	83.8	87.9
	Ngrohje Prated,h	dBA	79.6	80.9	83.5	83.1	86.5	85.3	89.8
Niveli i presionit të zërit	Ftohja Nom.	dBA	57.0		61.0	60.0	63.0	62.0	65.0
Gama e funksionimit	Ftohja Min.~Max.	°CDB				-5.0~43.0			
	Ngrohje Min.~Max.	°CWB				-20.0~15.5			
Ftohës	Lloji/GWP					R-410A/2,087.5			
	Ngarkimi	kg/TCO2Eq	5.9/12.3	6.0/12.5	6.3/13.2	10.3/21.5	11.3/23.6	11.7/24.4	11.8/24.6
Furnizimi me energji elektrike	Faza/Frekuenca/Tensioni	Hz/V				3N~/50/380-415			
Aktuale-50Hz Amplifikatorët maksimalë të siguresave(MFA)		A	20	25	32		40	50	

Panele Diellore

Ngrohje & Ftohje

Hidraulike

Hidrosanitare

Aksesore të ndryshëm

RQCEQ-P3

Zëvendësimi i VRV, rikuperimi i nxehtësisë

Shpejt & zëvendësim cilësor për sistemet R-22 dhe R-407C



RQCEQ712-848P3

VRV III-Q



Sistemi i njësive së jashtme		RQCEQ	280P3	460P3	500P3	540P3	712P3	744P3	816P3
Sistemi	Moduli i njësive së jashtme 1			RQE140P3		RQE180P3		RQE140P3	RQE180P3
	Moduli i njësive së jashtme 2			RQE140P3		RQE180P3		RQE140P3	RQE212P3
	Moduli i njësive së jashtme 3					RQE180P3			RQE212P3
	Moduli i njësive së jashtme 4								RQE212P3
Gama e kapacitetit	HP	10	16	18	20	24		26	28
Kapaciteti ftohës	Prated,c	kW	28.0	46.0	50.0	54.0	70.0	72.0	78.0
Kapaciteti i ngrohjes	Prated,h	kW	32.0	52.0	56.0	60.0	78.4	80.8	87.2
Kombinimi i rekomanduar			4x FXMQ63P7VEB	4x FXMQ63P7VEB + 2x FXMQ80P7VEB	4x FXSQ32A2VEB + 8x FXSQ40A2VEB	12x FXSQ40A2VEB	4x FXSQ32A2VEB + 9x FXSQ40A2VEB + 3x FXSQ50A2VEB	4x FXSQ32A2VEB + 6x FXSQ40A2VEB + 6x FXSQ50A2VEB	7x FXSQ40A2VEB + 9x FXSQ50A2VEB
rs,c	%	200	191	201	198		194		204
rs,h	%	159	161	150	148	153		155	
Numri maksimal i njësive të brendshme të lidhura		21	34	39	43	52	56	60	
Lidhja e indeksit të brendshëm	Min.	140	230	250	270	356	372	408	
	Nom.	280		500	540	712	744	816	
	Max.	364	598	650	702	926	967.0	1,061	
Lidhjet e tubacioneve	E lëngshme	OD	mm	9.52	12.7		15.9		19.1
		Gaz	mm	22.2		28.6		34.9	
	Sistemi total i tubacioneve aktualë	Gjatësia	m				300		
		Furnizimi me energji elektrike	Faza/Frekuenca/Tensioni	Hz/V				3~/50/400	
Aktuale - 50Hz	Amplifikatorët maksimalë të siguresave (MFA)	A	30	50	60		80	90	

Moduli i njësive së jashtme		RQEQ-P3	140P3	180P3	212P3
Dimensionet	Njësia	LartësiaxGjerësiaxThellësia	mm		1,680x635x765
Pesha	Njësia		kg	175	179
Fan	Ftohja e rrjedhës së ajrit Nom. norma		m ³ /min	95	110
		Lloji			Propeller fan
Niveli i fuqisë së zërit	Ftohja Nom.		dBa	79	83
		Ngrohje sipas ENER LOT21	dBa	79	84
Niveli i presionit të zërit	Ftohja Nom.		dBa	-	-
Gama e funksionimit	Ftohja Min.~Max.		°CDB	-5 ~43	-
		Ngrohje Min.~Max.	°CWB	-20 ~15.5	-
Ftohës	Lloji/GWP			R-410A/2,087.5	
		Ngarkimi	kg/TCO2Eq	10.3/21.5	10.6/22.1
Furnizimi me energji elektrike	Faza/Frekuenca/Tensioni		Hz/V		3~/50/380-415
		Aktuale - 50Hz	Amplifikatorët maksimalë të siguresave(MFA)	A	15
					22.5

HXHD-A8

Hidrobox me temperaturë të lartë për VRV

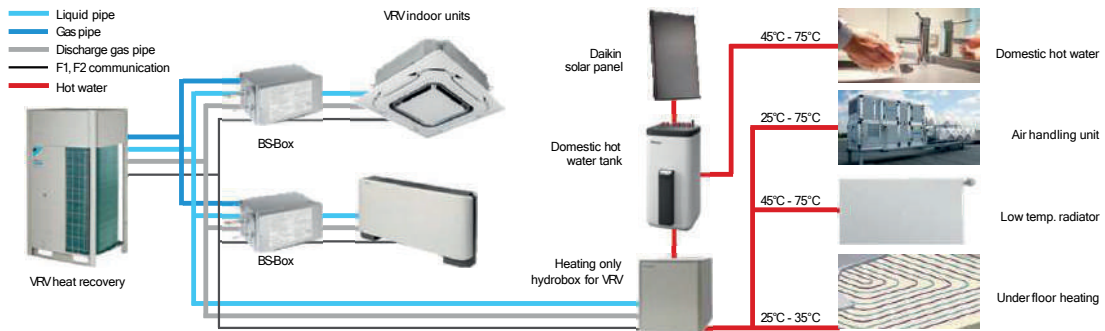
Për prodhim efikas të ujit të nxehtë dhe ngrohje të hapësirës



Njësia e brendshme		HXHD	080A8	125A8	
Kapaciteti ftohës	Nom.	kW	8.0 (1)	12.5 (1)	
Kapaciteti i ngrohjes	Nom.	kW	9.00 (2)	14.00 (2)	
Shtresë	Ngjyrë			E bardha	
	Materiali			Llamarina e paralyer	
Dimensionet	Njësia	LartësiAxGjerësiAxThellësia	mm	890x480x344	
Pesha	Njësia		kg	44.0	
Gama e funksionimit	Ngrrohje	Ambient	Min.~Max.	°C	-20 ~24
		Ana e ujit	Min.~Max.	°C	25 ~45
	Ftohja	Ambient	Min.~Max.	°CDB	10 ~43
		Ana e ujit	Min.~Max.	°C	5 ~20
Ftohës	Lloji/GWP			R-410A	
	Ngarkimi		Kg	2,087.5	
Niveli i fuqisë së zërit	Nom.		dB(A)	31	
Niveli i presionit të zërit	Nom.		dB(A)		
	Modeli i qetesise se nates. Nivel 1		dB(A)		
Qarku i ujit	Diametri i lidhjeve të tubacioneve		mm	15.9	
	Sistemi i ujit te ngrohje. Maks. ~ Min.		mm	9.5	
Furnizimi me energji elektrike	Diametri i lidhjeve të tubacioneve		inch	G 1"1/4 (femër)	
Furnizimi me energji elektrike	Faza / Frekuenca / Tensioni		Hz / V	1~ / 50 / 220-240	
Aktuale	Siguresat e rekomanduara		A	6~ 16	

Pompa Daikin të nxehtësisë me temperaturë të ulët

BLUEVOLUTION

Daikin Altherma 3 R W

EHBX-E6V/E9W + ERGA-EV(H)

Ngrohje dhe ftohje



Të dhënat e efikasitetit			EHBX + ERGA	04E6V + 04EV	08E6V + 06EVH	08E9W + 06EVH	08E6V + 08EVH7	08E9W + 08EVH7
Kapaciteti i ngrohjes	Nom.		kW	4.30 (1) / 4.60 (2)		6.00 (1) / 5.90 (2)		7.50 (1) / 7.80 (2)
Fuqia në hyrje	Ngrohje	Nom.	kW	0.850 (1) / 1.26 (2)		1.24 (1) / 1.69 (2)		1.63 (1) / 2.23 (2)
Kapaciteti i ftohjes	Nom.		kW	4.86 (1) / 4.52 (2)		5.96 (1) / 5.09 (2)		6.25 (1) / 5.44 (2)
Fuqia në hyrje	Ftohje	Nom.	kW	0.810 (1) / 1.36 (2)		1.06 (1) / 1.55 (2)		1.16 (1) / 1.73 (2)
COP				5.10 (1) / 3.65 (2)		4.85 (1) / 3.50 (2)		4.60 (1) / 3.50 (2)
EER				5.98 (1) / 3.32 (2)		5.61 (1) / 3.28 (2)		5.40 (1) / 3.14 (2)
Ngrohja e hapësirës	Temp. mesatare e ujit në dalje 55 °C	Të përgjithshme	FUSHËVEPRIMI (SCOP)	329		328		335
			ηs (Efikasiteti sezonal i ngrohjes së hapësirës)	129		128		131
			Efikasiteti i ngrohjes sezonale të hapësirës, klasi				A++	
	Temp. mesatare e ujit në dalje 35 °C	Të përgjithshme	FUSHËVEPRIMI (SCOP)	454		452		461
			ηs (Efikasiteti sezonal i ngrohjes së hapësirës)	179		178		181
			Efikasiteti i ngrohjes sezonale të hapësirës, klasi				A+++	
Njësia e brendshme			EHBX	04E6V	08E6V	08E9W	08E6V	08E9W
Shtëpiza	Ngjyra		E bardhe + E zeze					
	Materiali		Llamarina e paralyer					
Dimensionet	Njësia	Lartësia x Gjerësia x Thellësia	mm	840 x 440 x 390				
Pesha	Njësia		kg	420		424	420	424
Diapazoni i funksionimit	Ftohje	Ana e ujit	Min.~Max.	°C				
	Ujë i ngrohtë për shtëpi	Ana e ujit	Min.~Max.	°C				
Niveli i presionit të zhurmës	Nom.		dBA	42				
Niveli i presionit të zhurmës	Nom.		dBA	28				
Njësi e jashtme			ERGA	04EV	06EVH	08EVH7		
Dimensionet	Njësia	Gjatësia x Gjerësia x Lartësia	mm	740 x 884 x 388				
Pesha	Njësia		kg	585				
Kompresori	Sasia			1				
	Tipi			Kompresor rrotullues i mbyllur hermetikisht				
Diapazoni i funksionimit	Ftohje	Min.~Max.	°CDB	10~43				
	Ujë i ftohtë për shtëpi	Min.~Max.	°CDB	-25~35				
Agjenti ftohës	Tipi			R-32				
	GWP			675.0				
	Ngarkesa		kg	150				
	Ngarkesa		TCO _{Eq}	101				
Niveli i presionit të zhurmës	Ngrohje	Nom.	dBA	58		60		62
	Ftohje	Nom.	dBA	61			62	
Niveli i presionit të zhurmës	Ngrohje	Nom.	dBA	44		47		49
	Ftohje	Nom.	dBA	48		49		50
Furnizimi me energji	Emri/Faza/Frekuenca/Tensioni		Hz/V	V3/1N~/50/230				
Rryma	Siguresa të rekomanduara		A	25				

Ky produkt përmban gazra serë të fluorizuar.



Daikin Altherma 3 H MT F

BLUEEVOLUTION

Pompa e nxehtësisë Daikin me temperaturë të lartë dhe mesatare

Daikin Altherma 3 H MT F

ETVX12E6V/E9W + EPRA08-12EV3/W1

Ngrohje, ftohje dhe ujë të ngrohtë



Të dhënat e efikasitetit		ETVX + EPRA	12S18E6V/E9W + 08EV3/W1	12S23E6V/E9W + 08EV3/W1	12S18E6V/E9W + 10EV3/W1	12S23E6V/E9W + 10EV3/W1	12S18E6V/E9W + 12EV3/W1	12S23E6V/E9W + 12EV3/W1	
Ngrohja e hapësirës	Temp. mesatare e ujit në dalje 55 °C	Të përgjithshme	FUSHËVEPRIMI (SCOP)	3,47 / 3,59		3,48 / 3,60			
		Efikasiteti i ngrohjes sezonale të hapësirës. klasi		136 / 141		A++			
	Temp. mesatare e ujit në dalje 35 °C	Të përgjithshme	FUSHËVEPRIMI (SCOP)	4,79 / 4,95		4,82 / 4,98			
		Efikasiteti i ngrohjes sezonale të hapësirës. klasi		188 / 195		190 / 196			
Ngrohja ujit	Të përgjithshme	Profili i ngarkesës së deklaruar	L						
		Klima mesatare	COPdhw	2,72 / 2,80	2,96 / 3,05	2,72 / 2,80	2,96 / 3,05	2,72 / 2,80	2,96 / 3,05
	Klima mesatare	gwh (efikasiteti i ngrohjes së ujit)	%	117 / 120	126 / 130	117 / 120	126 / 130	117 / 120	126 / 130
		Klasa e efikasitetit të energjisë për ngrohjen e ujit		A+					

Njësia e brendshme		ETVX	12S18E6V/D9W	12S23E6V/D9W	12S18E6V/D9W	12S23E6V/D9W	12S18E6V/D9W	12S23E6V/D9W
Shtëpiza	Ngjyra	Bardhë + E zezë						
	Materiali	Llamarinë e paralyer						
Dimensione	Njësia	GjatësiaxGjërësiaxLartësia	mm	1.650x595x625	1.850x595x625	1.650x595x625	1.850x595x625	1.650x595x625
Pesha	Njësia	kg	108	117	108	117	108	117
Rezervuari	Vëllimi i ujit	l	180	230	180	230	180	230
	Temperatura maksimale e ujit	°C	70					
	Presioni maksimal i ujit	bar	10					
	Mbrojtja nga korrozioni	Pasivizimi kimik						
Gama e funksionimit	Ujë i ngrohtë për shtëpi	Ana e ujit	Min.~Maks.	°C		10 ~ 65		
Niveli i fuqisë së zërit	Nom.	dB(A)	44					
Niveli i presionit të zërit	Nom.	dB(A)	30					

Njësia e jashtme		EPRA	08EV3/W1	10EV3/W1	12EV3/W1
Dimensione	Njësia	GjatësiaxGjërësiaxLartësia	mm	1.019x1.270x533	
Pesha	Njësia	kg	118		
Kompresori	Sasia	1			
	Lloji	Kompresori rrotullues i mbyllur hermetikisht			
Gama e funksionimit	Ngrohje	Min.~Maks.	°CDB		-28 ~ 25
	Ftohja	Min.~Maks.	°CDB		10 ~ 43
	Ujë i ngrohtë për shtëpi	Min.~Maks.	°CDB		-28 ~ 35
Ftohësi	Lloji	R-32			
	GWP	675			
	Ngarkimi	kg	3,25		
	Ngarkimi	TCO ₂ Eq	2,19		
LW(A) Niveli i fuqisë së zërit (sipas EN14825)	Ngrohje	Nom.	dB(A)	55,6	
	Ftohja	Nom.	dB(A)	61,2	61,4
Niveli i presionit të zërit (në 1 metër)	Ngrohje	Nom.	dB(A)	41,1	
	Ftohja	Nom.	dB(A)	47,1	
Furnizimi me energji elektrike	Emri / Faza / Frekuenca / Tensioni	Hz/V	V3/1~/50/230 - W1/3~/50/400		
Rryma	Signuresat e rekomanduara	A	V3: 32 - W1: 16		

Ky produkt përmban gazra serë të fluorizuar.

Panele Diellore

Ngrohje & Ftohje

Hidraulike

Hidrosanitare

Aksesore të ndryshëm

ETSH16E7 + EPRA14-18DV37/W17

Daikin Altherma 3 H HT ECH₂O

Pompë nxehtësie ajër-ujë ,nga dyshemeja, për ngrohje dhe ujë të ngrohtë sanitar , me njesi solare te integruar.

 011-1W0355-356
 011-1W0359-360
 011-1W0363-364

Të dhënat e efikasitetit		ETSH + EPRA		16P30E7 + 14DV7/W7	16P50E7+ 14DV7/W7	16P30E7 + 16DV7/W7	16P50E7 + 16DV7/W7	16P30E7 + 18DV7/W7	16P50E7 + 18DV7/W7
Ngrohja e hapësirës	Temp. mesatare e ujit në dalje 55 °C	Të përgjithshme	FUSHËVEPRIMI (SCOP)	3.58/3.57					
			ηs (Efikasiteti sezonal i ngrohjes së hapësirës)	140					
		Efikasiteti i ngrohjes sezonale të hapësirës. Klasi	A++						
	Temp. mesatare e ujit në dalje 35 °C	Të përgjithshme	FUSHËVEPRIMI (SCOP)	4.51/4.71					
		ηs (Efikasiteti sezonal i ngrohjes së hapësirës)	177/186						
		Efikasiteti i ngrohjes sezonale të hapësirës. klasi	A+++						
Ngrohja ujit	Të përgjithshme	Profili i ngarkesës së deklaruar	L	XL	L	XL	L	XL	
	Klima mesatare	COPdhw	2.86 / 2.85	3.00/2.99	2.86/2.85	3.00/2.99	2.86/2.85	3.00/2.99	
		ηwh (efikasiteti i ngrohjes së ujit)	%	124	125	124	125	124	125
		Klasa e efikasitetit të energjisë për ngrohjen e ujit	A+						

Njësia e brendshme		ETSH	16P30E7	16P50E7	16P30E7	16P50E7	16P30E7	16P50E7	
Shtëpiza	Ngjyra	I bardhë (RAL 9016) / Gri i errët (RAL 7011)							
	Materiall	Polipropileni rezistent ndaj goditjeve							
Dimensione	Njësia	GjatësiaxGjërësiaxLartësia	mm	1,892x594x644	1,910x792x816	1,892x594x644	1,910x792x816	1,892x594x644	1,910x792x816
Pesha	Njësia	kg	75	98	75	98	75	98	
Rezervuari	Vëllimi i ujit		294	477	294	477	294	477	
		Temperatura maksimale e ujit	°C	85					
Gama e funksionimit	Ngrohje	Ambienti	Min.~Max.	°C					
		Ana e ujit	Min.~Max.	°C					
	Ujë i ngrohtë për shtëpi	Ambienti	Min.~Max.	°C					
		Ana e ujit	Min.~Max.	°C					
Niveli i fuqisë së zërit	Nom.	dB(A)	45.6						
Niveli i presionit të zërit	Nom.	dB(A)	32.8						

Njësia e jashtme		EPRA	14DV37/W17	16DV37/W17	18DV37/W17
Dimensione	Njësia	GjatësiaxGjërësiaxLartësia	mm	1,003x1,270x533	
Pesha	Njësia	kg	146/151		
Kompresori	Sasia		1		
	Lloji		Kompresori rrotullues i mbyllur hermetikisht		
Gama e funksionimit	Ngrohje	Min.~Max.	°CDB		
	Ujë i ngrohtë për shtëpi	Min.~Max.	°CDB		
Ftohësi	Lloji		R-32		
	GWP		675		
	Ngarkimi	kg	4.20		
	Ngarkimi	TCO ₂ Eq	2.84		
LW(A) Niveli i fuqisë së zërit (sipas EN14825)			54		

Niveli i presionit të zërit (në 1 metër)	Nom.		43.0	48.0
Furnizimi me energji elektrike	Emri / Faza / Frekuenca / Tensioni	Hz/V	V3/1~/50/230 /W1/3~/50/400	
Rryma	Siguresat e rekomanduara	A	32/16	

Ky produkt përmban gazra serë të fluorizuar.

Daikin Altherma 3 M

EBLA04-08E(3)V3

Daikin Altherma 3 M

Sistem monoblok i kthyeshëm, ajër-ujë që ofron ngrohje dhe ftohje dhe është ideal për hapësirat e brendshme që kanë hapësirë të kufizuar

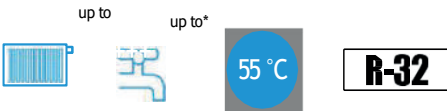
BLUEEVOLUTION

Njësia e jashtme				EBLA	04E(3)V3	06E(3)V3	08E(3)V3
Kapaciteti i ngrohjes	Nom.			kW	4.30 (1) / 4.60 (2)	6.00 (1) / 5.90 (2)	7.50 (1) / 7.80 (2)
Fuqia në hyrje	Ngrohje	Nom.		kW	0.84 (1) / 1.26 (2)	1.24 (1) / 1.69 (2)	1.63 (1) / 2.23 (2)
COP					5.10 (1) / 3.65 (2)	4.85 (1) / 3.50 (2)	4.60 (1) / 3.50 (2)
Kapaciteti i ftohjes	Nom.			kW	4.86 (1) / 4.52 (2)	5.83 (1) / 5.09 (2)	6.18 (1) / 5.44 (2)
Fuqia në hyrje	Ftohje	Nom.		kW	0.82 (1) / 1.36 (2)	1.08 (1) / 1.55 (2)	1.19 (1) / 1.73 (2)
EER					5.91 (1) / 3.32 (2)	5.40 (1) / 3.28 (2)	5.19 (1) / 3.14 (2)
Ngrohja e hapësirës	Temp. Mesatare e ujit në dalje 55 °C	ηs (Efikasiteti sezonal i ngrohjes së hapësirës)		129	128	131	
		FUSHËVEPRIMI (SCOP)		3.29	3.28	3.35	
	Temp. Mesatare e ujit në dalje 35 °C	ηs (Efikasiteti sezonal i ngrohjes së hapësirës)		179	178	181	
		FUSHËVEPRIMI (SCOP)		4.54	4.52	4.61	
Shtëpiza				E bardhë e fildishtë			
Materiali				Çeliku i galvanizuar me karbon të ulët			
Dimensionet	Njësia	GjatësiaxGjërësiaxLartësia		mm	770 x 1,250 x 362		
Pesha	Njësia			kg	EV3: 88, E3V3: 91		
Kompresori	Sasia			1			
Lloji				Kompresor rrotullues i mbyllur hermetikisht			
Gama e funksionimit	Ngrohje	Ambienti	Min.~Max.	°CWB	-25 ~ 35		
		Ana e ujit	Min.~Max.	°C	EV3: 9 ~ 65 / E3V3: 15 ~ 65		
	Ftohje	Ambienti	Min.~Max.	°CDB	10 ~ 43		
		Ana e ujit	Min.~Max.	°C	5 ~ 22		
	Ujë i ngrohtë për shtëpi	Ambienti	Min.~Max.	°CDB	-27 ~ 35		
		Ana e ujit	Min.~Max.	°C	25 ~ 55		
Ftohësi	Lloji			R-32			
	GWP			675			
	Ngarkimi			kg			
	Ngarkimi			TCO2Eq			
	Ngarkimi			Valvula e zgjerimit			
Niveli i presionit të zërit	Ngrohje	Nom.		dB(A)	58	60	62
Furnizimi me energji elektrike	Emri / Faza / Frekuenca / Tensioni			Hz/V	V3/1~/50/230		
Rryma	Siguresat e rekomanduara			A	20	25	

Ky produkt përmban gazra serë të fluorizuar.

Panele Diellore

Ngrohje & Ftohje

Hidraulike

Hidrosanitare

Aksesore të ndryshëm

Daikin Altherma 3 R – ERGA06-08EVH
BLUEEVOLUTION

Pompa Daikin të nxehtësisë me temperaturë të ulët

Daikin Altherma 3 R F

Daikin Altherma 3 R – ERGA06-08EVH

Ngrohje, ftohje dhe ujë të ngrohtë



Njësia e jashtme		ERGA		06EVH		08EVH	
Kapaciteti i ngrohjes	Nom.	kW		6.00 (1) / 5.90 (2)		7.50 (1) / 7.80 (2)	
Fuqia në hyrje	Ngrohje Nom.	kW		1.24 (1) / 1.69 (2)		1.63 (1) / 2.23 (2)	
COP				4.85 (1) / 3.50 (2)		4.60 (1) / 3.50 (2)	
Kapaciteti i ftohjes	Nom.	kW		5.83 (1) / 5.09 (2)		6.18 (1) / 5.44 (2)	
Fuqia në hyrje	Ftohje Nom.	kW		1.08 (1) / 1.55 (2)		1.19 (1) / 1.73 (2)	
EER				5.40 (1) / 3.28 (2)		5.19 (1) / 3.14 (2)	
Ngrohja e hapësirës	Temp. Mesatare e ujit në dalje 55 °C	ηs (Efikasiteti sezonal i ngrohjes së hapësirës)		128		131	
		FUSHËVEPRIMI (SCOP)		3.28		3.35	
	Efikasiteti i ngrohjes sezonale të hapësirës, klasi				A++		
	Temp. Mesatare e ujit në dalje 35 °C	ηs (Efikasiteti sezonal i ngrohjes së hapësirës)		178		181	
FUSHËVEPRIMI (SCOP)		4.52		4.61			
Efikasiteti i ngrohjes sezonale të hapësirës, klasi				A+++			
Shtëpiza	Ngjyra			E bardhë			
	Materiali			Çeliku i galvanizuar me karbon të ulët			
Dimensionet	Njësia	Gjatësi x Gjerësi x Lartësia	mm	740 x 884 x 388			
Pesha	Njësia		kg	58,5			
Kompresori	Sasia			1			
	Lloji			Kompresor rrotullues i mbyllur hermetikisht			
Gama e funksionimit	Ngrohje	Ambienti	Min.~Max.	°CWB	-25 ~ 35		
		Ana e ujit	Min.~Max.	°C	EV3: 9 ~ 65 / E3V3: 15 ~ 65		
	Ftohje	Ambienti	Min.~Max.	°CDB	10 ~ 43		
		Ana e ujit	Min.~Max.	°C	5 ~ 22		
	Ujë i ngrohtë për shtëpi	Ambienti	Min.~Max.	°CDB	-27 ~ 35		
		Ana e ujit	Min.~Max.	°C	25 ~ 55		
Ftohësi	Lloji			R-32			
	GWP			675			
	Ngarkimi			kg		1.50	
	Ngarkimi			TCO2Eq		1.01	
	Ngarkimi					Valvula e zgjerimit	
Niveli i presionit të zërit	Ngrohje	Nom.		dBA	60	62	
Furnizimi me energji elektrike	Emri / Faza / Frekuenca / Tensioni			Hz/V	V3/1~/50/230		
Rryma	Siguresat e rekomanduara			A	25	25	

Ky produkt përmban gazra serë të fluorizuar.

Daikin Altherma 3 H – EPGA011-016DV

Pompa e nxehtësisë Daikin me temperaturë të lartë dhe mesatare

Daikin Altherma 3 H – EPGA011-016DV

Ngrohje dhe ujë i ngrohtë



Njësia e jashtme		EPGA	11DV7	14DV7	16DV7	
Dimensione	Njësia	GjatësiaxGjërësiaxLartësia	mm	1.440 x 1.160 x 380		
Pesha	Njësia		kg	143		
Kompresori	Sasia			1		
	Lloji			Kompresori rrotullues i mbyllur hermetikisht		
Gama e funksionimit	Ngrohje	Min.~Maks.	°CDB	-28~35		
	Ftohja	Min.~Maks.	°CDB	10~43		
	Ujë i ngrohtë	Min.~Maks.	°CDB	-28~35		
Ftohësi	Lloji			R-32		
	GWP			675		
	Ngarkimi		kg	3,50		
	Ngarkimi		TCO:Eq	2,36		
Niveli i fuqisë së zërit	Ngrohje	Nom.	dBA	Valvula e zgjerimit		
					64	66
Niveli i presionit të zërit	Ftohja	Nom.	dBA	68		
Niveli i presionit të zërit	Ngrohje	Nom.	dBA	48	49	
Furnizimi me energji elektrike	Ftohja	Nom.	dBA	55		
Furnizimi me energji elektrike	Emri / Faza / Frekuenca / Tensioni		Hz/V	V3/1N~/50/230		
Rryma	Siguresat e rekomanduara		A	32		



Daikin Altherma 3 H HT – EPRA014-018DV

Pompa e nxehtësisë Daikin me temperaturë të lartë dhe mesatare



BLUEEVOLUTION

Daikin Altherma 3 H HT – EPRA014-018DV

Ngrohje, ftohje dhe ujë i ngrohtë



Njësia e jashtme			EPRA	14DV3/W1	16DV3/W1	18DV3/W1
Dimensione	Njësia	GjatësiaxGjerësiaxLartësia	mm		1.019x1.270x533	
Pesha	Njësia		kg		146/151	
Kompresori	Sasia				1	
	Lloji				Kompresori rrotullues i mbyllur hermetikisht	
Gama e funksionimit	Ngrohje	Min.~Maks.	°CDB		-28 ~ 35	
	Ftohje	Min.~Maks.	°CDB		10 ~ 43	
	Ujë i ngrohtë për shtëpi	Min.~Maks.	°CDB		-28 ~ 35	
Ftohësi	Lloji				R-32	
	GWP				675	
	Ngarkimi		kg		4,20	
	Ngarkimi		TCO2Eq		2,84	
	Kontrolli				Valvula e zgjerimit	
LW(A) Niveli i fuqisë së zërit (sipas EN14825)	Ngrohje	Nom.	dBa		56	59
	Ftohje	Nom.	dBa		56	59
Niveli i presionit të zërit (në 1 metër)	Ngrohje	Nom.	dBa		43	48
	Ftohje	Nom.	dBa		43	48
Furnizimi me energji elektrike	Emri / Faza / Frekuenca / Tensioni		Hz/V		V3/1~/50/230 / W1/3~/50/400	
Rryma	Siguresat e rekomanduara		A		32/16	

Ky produkt përmban gazra serë të fluorizuar.



Daikin Altherma 3 R – ERLA11-16DV3

Pompa Daikin të nxehtësisë me temperaturë të ulët

Daikin Altherma 3 R – ERLA11-16DV3

ERLA11-16DV3

Ngrohje, ftohje dhe ujë i ngrohtë



BLUEVOLUTION



deri në



A+++

60°C

R-32

Njësia e jashtme	ERLA		11DV3	14DV3	16DV3
Dimensionet	Njësia	Lartësia x Gjerësia x Thellësia	mm	870x1.110x530	
Pesha	Njësia		kg	101	
Kompresor	Sasia			1	
	Lloji			Kompresor inverter rrotullues i mbyllur hermetikisht	
Gama e funksionimit	Ngrohje	Min.~Max.	°CDB	-25 ~ 35	
	Ftohje	Min.~Max.	°CDB	10 ~ 43	
	Ujë i ngrohtë për shtëpi	Min.~Max.	°CDB	-25 ~ 35	
Ftohës	Lloji			R-32	
	GWP			675	
	Ngarkimi		kg	3,80	
	Ngarkimi		TCO2Eq	2,57	
	Kontrolli			Valvula e zgjerimit	
Niveli i fuqisë së zërit (sipas EN14825)				62	
Niveli i presionit të zërit (at 1 meter)	Nom.			48	
Furnizimi me energji elektrike	Emri / Faza / Frekuenca / Tensioni		Hz/V	V3/1~/50/230 / W1/3~/50/400	
Aktuale	Siguresat e rekomanduara		A	32/16	

Ky produkt përmban gazra serë të fluorizuar.

Daikin Altherma 3 R – ERLA11-16DW1

Pompa Daikin të nxehtësisë me temperaturë të ulët

BLUEEVOLUTION

Daikin Altherma 3 R – ERLA11-16DW1

ERLA11-16DW1

Ngrohje, ftohje dhe ujë i ngrohtë



deri në



A+++

60°C

R-32

Njësia e jashtme		ERLA		11DW1	14DW1	16DW1
Dimensionet	Njësia	Lartësia x Gjerësia x Thellësia	mm		870x1.110x530	
Pesha	Njësia		kg		101	
Kompresor	Sasia				1	
	Lloji				Kompresor inverter rrotullues i mbyllur hermetikisht	
Gama e funksionimit	Ngrohje	Min.~Max.	°CDB		-25 ~ 35	
	Ftohje	Min.~Max.	°CDB		10 ~ 43	
	Ujë i ngrohtë për shtëpi	Min.~Max.	°CDB		-25 ~ 35	
Ftohës	Lloji				R-32	
	GWP				675	
	Ngarkimi		kg		3,80	
	Ngarkimi		TCO2Eq		2,57	
	Kontrolli				Valvula e zgjerimit	
Niveli i fuqisë së zërit (sipas EN14825)					62	
Niveli i presionit të zërit (at 1 meter)	Nom.				48	
Furnizimi me energji elektrike	Faza / Frekuenca / Tensioni		Hz/V		V3/1~/50/230 / W1/3~/50/400	
Aktuale	Siguresat e rekomanduara		A		32/16	

Ky produkt përmban gazra serë të fluorizuar.

EKHWB-B/EKHWP-PB

Depozitë Termike

Depozitë plastike e ujit të ngrohtë sanitar, me mbështetje për panel diellor



EKHWB500B

EKHWB300B

Aksesorë		EKHWP	300B	500B	300PB	500PB	
Shtëpiza	Ngjyra	E bardhë (RAL9016) / Gri e errët (RAL7011)					
	Materiali	Polipropileni rezistent ndaj goditjeve					
Dimensionet	Njësia	Gjerësia	mm	595	790	595	790
		Thellessia	mm	615	790	615	790
Pesha	Njësia	I zbrazët	kg	58	82	58	89
Depozita	Volumi i ujit		l	294	477	294	477
	Materiali		Polipropileni				
	Temperatura max e ujit		°C	85			
	Izolimi	Humbja e nxehtësise	kWh/24h	1.5	1.7	1.5	1.7
	Klasa e efikasitetit të energjisë		B				
	Humbja e vazhdueshme e nxehtësisë		W	64	72	64	72
	Vëllimi i ruajtës		l	294	477	294	477
Shkembyesi i nxehtësisë	Uji ngrohtë për shtëpi	Sasia	1				
		Materiali i tubit	Çelik inox (DIN 1.4404)				
	Sipërfaqja e përparme	m ²	5,600	5,800	5,600	5,900	
	Vëllimi i brendshëm i spirales	l	27.1	28.1	27.1	28.1	
	Presioni i funksionimit	bar	6				
	Prodhimi mesatar i nxehtësisë specifike	W/K	2,790	2,825	2,790	2,825	
	Ngarkesa	Sasia	1				
		Materiali i tubit	Çelik inox (DIN 1.4404)				
	Sipërfaqja e përparme	m ²	3	4	3	4	
	Vëllimi i brendshëm i spirales	l	13	18	13	18	
Presioni i funksionimit	bar	3					
Prodhimi mesatar i nxehtësisë specifike	W/K	1,300	1,800	1,300	1,800		
Presioni Solar	Prodhimi mesatar i nxehtësisë specifike	W/K	-	-	390	840	
Ngrohja diellore	Materiali Tubit		-	Çelik inox (DIN 1.4404)	-	Stainless steel (DIN 1.4404)	
	ndihmëse	Sipërfaqja e përparme	m ²	-	1	-	1
	Vëllimi i brendshëm i spirales	l	-	4	-	4	
	Presioni i funksionimit	bar	-	3	-	3	
	Prodhimi mesatar i nxehtësisë specifike	W/K	-	280	-	280	



Daikin Altherma M HW – EKHH2E-AV33



EKHH2E-AV3

Daikin Altherma M HW – EKHH2E-AV33

Rehati e shtuar e ujit të nxehtë



EKHH2E-AV3

Njësia e brendshme		EKHH2E/EKHH2E		2E200AV3	2E260AV3	2E260PAV3	
COP				3.00(1) / 3.30(2)		3.10(1) / 3.60(2)	
 Pompa e nxehtësisë	Shtëpiza	Ngjyra		Trupi i bardhë / pjesa e sipërme gri			
		Materiali		Mbulimi i jashtëm: Mbarimi i sipërm EPP			
	Gama e funksionimit	Ambienti	Min.	°CDB	-7		
			Max.	°CDB	38		
	Furnizimi me energji elektrike	Faza			1P		
		Frekuenca			50		
Tensioni				230			
 Depozita	Shtëpiza	Ngjyra		White			
		Materiali		ABS i stampuar			
	Dimensionet	Njësia	Lartësia	mm	1,210		1,500
	Gama e funksionimit	Ana e ujit	Min.	°C	10		
			Max.	°C	56		
Humbja e vazhdueshme e nxehtësisë			W	60	70	71	
Furnizimi me energji elektrike	Faza			1P			
	Frekuenca			50			
	Tensioni			230			

Temperatura e furnizimit me ajër në hyrje = 7°C, temperatura e ambientit të ruajtjes së bojlerit = 20°C, uji i ngrohur nga 10°C deri në 55°C (sipas UNI EN 16147-2011).

Temperatura e furnizimit të ajrit në hyrje = 15°C, temperatura e ambientit të ruajtjes së bojlerit = 20°C, uji i ngrohur nga 10°C deri në 55°C (sipas UNI EN 16147-2011).

EKHTS-AC

Rezervuari i ujit të ngrohtë sanitar

Depozitë inoxi për ujin e ngrohtë në shtëpi me vendosje mbi njëra-tjetrën



Aksesorë	EKHTS(U)			200AC	260AC
Shtëpiza	Ngjyra	Gri metalike			
	Materiali	Çeliku i galvanizuar (llamarina e paralyer)			
Dimensionet	Njësia	Lartësia	I integruar me njësitet e brendëshme	mm	2,010
		Gjerësia		mm	600
		Thellesi		mm	695
		Lartësia		mm	1,470
Pesha	Njësia	I zbrazët		kg	70
					78
Depozita	Vëllimi i ujit			l	200
	Materiali				260
	Temperatura maksimale e ujit			°C	75
	Izolimi	Humbja e nxehtësisë		kWh/24h	12.0
	Klasa e efikasitetit të energjisë				B
	Humbja e vazhdueshme e nxehtësisë			W	50
	Vëllimi i ruajtës			l	200
					260
Shkembyesi i nxehtësisë	Sasia				1
	Materiali i tubit				Çelik i dyfishtë (EN 1.4162)
	Sipërfaqja e përparme			m ²	1.560
	Vëllimi i brendshëm i spirales			l	7.5

Panele Diellore

Ngrohje & Ftohje

Hidraulike

Hidrosanitare

Aksesore të ndryshëm

EKHW(S)(U)-D

Depozitë inoksi për ujin e ngrohtë në shtëpi

Rezervuar inoksi për ujin e ngrohtë në shtëpi.

I disponueshëm në 150, 200 dhe 300 litra



EKHW(S)(U)-D

Aksesorë		EKHWS	150(U)D3V3	180(U)D3V3	200(U)D3V3	250(U)D3V3	300(U)D3V3		
Shtëpiza	Ngjyra	E bardhe ,neutrale							
	Materiali	Çeliku i veshur me epoksid / Çeliku i butë i veshur me epoksid							
Pesha	Njësia	I zbrazët	kg	45	50	53	58	63	
Depozita	Volumi i ujit		l	145	174	192	242	292	
	Materiali	Çelik inox(EN 1.4521)							
	Temperatura max e ujit		°C			75			
	Izolimi	Humbja e nxehtësisë		kWh/24h	1.1	1.2	1.3	1.4	1.6
	Klasa e efikasitetit të energjisë	B							
	Humbja e vazhdueshme e nxehtësisë		W	45	50	55	60	68	
Vëllimi i ruajtës		l	145	174	192	242	292		
Shkembyesi i nxehtësisë për shtëpi	Uji ngrohtë	Sasia	1						
	Materiali tubit	Çelik inox (EN 1.4521)							
	Sipërfaqja e përparme	m ²	1,050	1,400		1,800			
	Vëllimi i brendshëm i spirales	l	4.9	6.5		8.2			
Presioni i funksionimit		bar	10						
Ngrohës ndihmës	Kapaciteti		kW	3					
Furnizimi me energji elektrike	Faza / Frekuenca / Tensioni		Hz/V	1~/50/230					



BE SMART CHOOSE XTRON



Zgjidhje kondicionimi për shtëpinë tuaj

XTRON

Kondicioner me montim në mur



Të dhënat e efikasitetit	new F-9000BTU	new F-12000BTU	new F-18000BTU	new F-24000BTU
Tensioni i vlerësuar	220v-240v	220v-240v	220v-240v	220v-240v
Frekuenca e vlerësuar	50Hz	50Hz	50Hz	50Hz
Fuqia Ftohese (kW)	2.6	3.4	5.1	6.7
Fuqia ngrohje (kW)-mesatare	2.1	2.3	3.3	5.7
Fuqia ngrohje (kW)-ngrohtare	2.3	3.1	3.6	7
"Konsumit vjetor i energjisë ne ftohje (kWh/a)"	149	192	265	359
"Konsumit vjetor i energjisë ne ngrohje (kwh/a)-mesatare"	722	797	1144	1950
"Konsumit vjetor i energjisë ne ngrohje (kwh/a)-Më e ngrohtë"	618	841	937	1859
GWP	675	675	675	675
Kapaciteti ftohës (BTU/H)	8871.2(2047.2~10577.2)	11600.8(2729.6~12965.6)	17401.2(4435.6~18083.6)	24566.4(6141.6~25248.8)
Kapaciteti ftohës (kW)	2.6(0.6~3.1)	3.4 (0.8~3.8)	5.1 (1.3-5.3)	7.2 (1.8-7.4)
Kapaciteti i ngrohjes (BTU/H)	8905.32	11942(3412~13648)	17742.4 (4435.6~18083.6)	24566.4(6141.6~27296)
Kapaciteti i ngrohjes (kW)	2.61(0.8~3.4)	3.5 (0.8~4.0)	5.2(1.3-5.3)	7.2 (1.8-8.0)
Rryma e ftohjes (A)	3.9(0.9-6.9)	3.9(0.9-6.9)	7.4(1.2-7.9)	10
Rryma e ngrohjes (A)	3.0(1.3-6.9)	3.0(1.3-6.9)	6.2(1.0-6.6)	9.5 (1.0-11)
Hyrja e ftohjes (kW)	0.8(0.1~1.6)	1.34(0.2-1.5)	1.67(0.28-1.8)	2.2(0.23~2.76)
Hyrja e ngrohjes (kW)	0.7(0.3-1.5)	0.95 (0.2~1.4)	1.40(0.22-1.5)	2.2(0.23~2.53)
Kapaciteti i dehumidifikimit (Kg/h)	1	1	1.6	2.5
Ftohja SEER	6.1	6.2	6.7	6.53
Klasa e energjisë SEER	A++	A++	A++	A++
SCOP Mesatarja e ngrohjes	4	4	4	4.09
Mesatarja e klasës së energjisë SCOP	A+	A+	A+	A+
SCOP Ngrohje-ngrohëse	5.1	5.1	5.3	5.27
Ngrohëse e klasës së energjisë SCOP	A+	A+	A+	A+
Rryma maksimale e hyrjes (A)	8.5	9	9	16
Fuqia maksimale hyrëse (kW)	1.6	1.6	1.9	3.4
Presioni maksimal i shkarkimit (Mpa)	4.3	4.3	4.3	4.3
Presioni maksimal i thithjes (Mpa)	2.5	2.5	2.5	2.5
Ftohës	R32	R32	R32	R32
Sasia e ftohësit (kg)	0.51	0.55	0.54	1.3
tCO2eq.	0.38	0.37	0.36	0.88
Pesha neto e njësisë së brendshme (kg)	7	8	10	14
Pesha neto e njësisë së jashtme (kg)	18	18	23	39
Dimensioni(i brendshëm)-net	693×283×199	750*285*200	900×310×225	1082*330*233
Dimensioni (indoor)-paketë	745*340*270	802*350*262	950*372*292	1155*397*312
Dimensioni (jashtë)-net	650×233×455	650×233×455	715*280*537	900×700×350
Dimensioni (jashtë) -paketë	760*305*510	760*305*510	825*326*595	1020×770×430
sasia e ngarkimit (1*40HQ)	375	370	260	142
Dimensioni i valvulës së ndalimit	Dg4/Dg8 (1/4-3/8)	Dg4/Dg8 (1/4-3/8)	Dg4/Dg10 (1/4-1/2)	Dg4/Dg13 (1/4-5/8)
Marka e kompresorit	HIGHLY	HIGHLY	GMCC	SANYO
Lloji i motorit të ventilatorit (të brendshëm)	DC	DC	AC	DC
Lloji i motorit të ventilatorit (të jashtëm).	DC	DC	DC	DC
Parandalimi i goditjes elektrike në ambiente të brendshme	Class I	Class I	Class I	Class I
Klasa e brendshme e papërshkueshme nga uji	IPX0	IPX0	IPX0	IPX0
Klasa e papërshkueshme nga uji në natyrë	IPX4	IPX4	IPX4	IPX4
Gjatësia maksimale e tubit (m)	20	20	20	25
Rënia maksimale e instalimit (m) --* të dyja brenda më lart ose jashtë më lart*	10	10	10	15
*Tarifa shtesë e gazit për metër tub bakri i shtuar (g)"	20	20	20	30
Gjatësia maksimale e tubit (m) për gazin e parangarkuar	7	7	7	7
Temperatura e ambientit-ftohje	-15-50°C	-15-50°C	-15-50°C	-15-50°C
Temperatura e ambientit-ngrohje	-15-30°C	-15-30°C	-15-30°C	-15-30°C
Vëllimi i rrjedhës së ajrit (m3/h) - i brendshëm - shumë shpejtësia (Turbo-Hi-Mid-Low-Si)	550/490/440/390/350	600/540/490/440/400	850/760/680/610/550	1300/1180/1080/990/900

KALDAJA ELEKTRIKE

ECOMPACT PLUS - montim i lartë në mur



ECOMPACT UZ- - montim i lartë në mur



MODEL TK-PROFESIONAL-montim në dysHEME



Kodi	Përmasat	Cmimi
48475	6KW – 27KW	-

Kodi	Përmasat	Cmimi
44589	6kw – 16kw	-

Kodi	Përmasat	Cmimi
47142	50KW-60KW	-

PROCESSOR – MTRONIC 7000 - montim i lartë në mur



TK-Professional – montim në dysHEME



TK-Professional – montim në dysHEME



Kodi	Përmasat	Cmimi
54971	6KW – 24KW	-

Kodi	Përmasat	Cmimi
77153	120kw / 240kw	-

Kodi	Përmasat	Cmimi
34862	70kw / 100kw	-

Panele Djellore

Ngrohje & Ftohje

Hidraulike

Hidrosanitare

Aksesore të ndryshëm



PIPES

APE MULTYLAYER

Rakord mashkull me prese
AP 101



Kodi	Permasat	Sasia	Cmimi
3AP1011216	1/2" x 16	10	-
3AP1011218	1/2" x 18	10	-
3AP1011220	1/2" x 20	10	-
3AP1013416	3/4" x 16	10	-
3AP1013418	3/4" x 18	10	-
3AP1013420	3/4" x 20	10	-
3AP1013426	3/4" x 26	5	-
3AP1010126	1" x 26	5	-
3AP1010132	1" x 32	5	-
3AP1010140	1"1/4 x 40	5	-
3AP1010150	1"1/2 x 50	5	-
3AP1010263	2" x 63	2	-

Rakord femer me prese
AP 102



Kodi	Permasat	Sasia	Cmimi
3AP1021216	1/2" x 16	10	-
3AP1021218	1/2" x 18	10	-
3AP1021220	1/2" x 20	10	-
3AP1023418	3/4" x 18	10	-
3AP1023420	3/4" x 20	10	-
3AP1023426	3/4" x 26	5	-
3AP1020126	1" x 26	5	-
3AP1020132	1" x 32	5	-
3AP10211440	1"1/4 x 40	5	-
3AP1020140	1"1/2 x 40	5	-
3AP1020150	1"1/2 x 50	5	-

Reduksion me prese
AP 103



Kodi	Permasat	Sasia	Cmimi
3AP1032016	20 x 16	10	-
3AP1032018	20 x 18	10	-
3AP1032620	26 x 20	5	-
3AP1033226	32 x 26	5	-
3AP1034026	40 x 26	5	-
3AP1034032	40 x 32	5	-
3AP1035032	50 x 32	5	-
3AP1035040	50 x 40	5	-
3AP1036350	63 x 50	2	-

Bashkues me prese
art. AP 103



Kodi	Permasat	Sasia	Cmimi
3AP1031616	16 x 16	10	-
3AP1031818	18 x 18	10	-
3AP1032020	20 x 20	10	-
3AP1032626	26 x 26	5	-
3AP1033232	32 x 32	5	-
3AP1034040	40 x 40	5	-
3AP1035050	50 x 50	2	-
3AP1036363	63 x 63	2	-

Ti me prese art. AP 131



Kodi	Permasat	Sasia	Cmimi
3APT161616	16 x 16 x 16	10	-
3APT181818	18 x 18 x 18	10	-
3APT202020	20 x 20 x 20	10	-
3APT262626	26 x 26 x 26	5	-
3APT323232	32 x 32 x 32	5	-
3APT404040	40 x 40 x 40	2	-
3APT505050	50 x 50 x 50	2	-
3APT636363	63 x 63 x 63	1	-

Ti me presim femer
art. AP 132



Kodi	Permasat	Sasia	Cmimi
3AP1321216	1/2" x 16	10	-
3AP1321218	1/2" x 18	10	-
3AP1321220	1/2" x 20	10	-
3AP1323420	3/4" x 20	10	-
3AP1323426	3/4" x 26	5	-
3AP1320132	1" x 32	5	-
3AP1320140	1" x 40	2	-
3AP1320150	1" x 50	2	-
3AP1320163	1" x 63	1	-
3AP13211440	1" 1/4 x 40	2	-
3AP1320463	1" 1/4 x 63	1	-

Ti e reduktuar me prese
 art.AP 131

Kodi	Permasat	Sasia	Cmimi
3APT162016	16 x 20 x 16	10	-
3APT181616	18 x 16 x 16	10	-
3APT201616	20 x 16 x 16	10	-
3APT201620	20 x 16 x 20	10	-
3APT201818	20 x 18 x 18	10	-
3APT201820	20 x 18 x 20	10	-
3APT202016	20 x 20 x 16	10	-
3APT202620	20 x 26 x 20	5	-
3APT261620	26 x 16 x 20	5	-
3APT261626	26 x 16 x 26	5	-
3APT261826	26 x 18 x 26	5	-

 Ti e reduktuar me prese
 art.AP 131

Kodi	Permasat	Sasia	Cmimi
3APT262016	26 x 20 x 16	5	-
3APT262020	26 x 20 x 20	5	-
3APT262026	26 x 20 x 26	5	-
3APT262616	26 x 26 x 16	5	-
3APT262618	26 x 26 x 18	5	-
3APT262620	26 x 26 x 20	5	-
3APT263226	26 x 32 x 26	5	-
3APT321832	32 x 18 x 32	5	-
3APT322026	32 x 20 x 26	5	-
3APT322032	32 x 20 x 32	5	-
3APT322626	32 x 26 x 26	5	-

 Ti e reduktuar me prese
 art.AP 131

Kodi	Permasat	Sasia	Cmimi
3APT322632	32 x 26 x 32	5	-
3APT323226	32 x 32 x 26	5	-
3APT403240	40 x 32 x 40	2	-
3APT504050	50 x 40 x 50	2	-
3APT506350	50 x 63 x 50	1	-
3APT635063	63 x 50 x 63	1	-

 Ti me presim mashkull
 art.AP 133

Kodi	Permasat	Sasia	Cmimi
3AP1331216	16 x 1/2" x 16	10	-
3AP1331218	18 x 1/2" x 18	10	-
3AP1331220	20 x 1/2" x 20	10	-
3AP1333420	20 x 3/4" x 20	10	-
3AP1333426	26 x 3/4" x 26	5	-
3AP1330132	32 x 1" x 32	5	-

 Brryl me presim art.AP
 151

Kodi	Permasat	Sasia	Cmimi
3AP1510016	16 x 16	10	-
3AP1510018	18 x 18	10	-
3AP1510020	20 x 20	10	-
3AP1510026	26 x 26	5	-
3AP1510032	32 x 32	5	-
3AP1510040	40 x 40	5	-
3AP1510050	50 x 50	2	-
3AP1510063	63 x 63	2	-

 Brryl femer me presim
 art.AP 152

Kodi	Permasat	Sasia	Cmimi
3AP1521216	1/2" x 16	10	-
3AP1521218	1/2" x 18	10	-
3AP1521220	1/2" x 20	10	-
3AP1523420	3/4" x 20	10	-
3AP1523426	3/4" x 26	5	-
3AP1520126	1" x 26	5	-
3AP1520132	1" x 32	5	-
3AP15211440	1"1/4 x 40	2	-

Brryl mashkull me presim
art. AP 153



Kodi	Permasat	Sasia	Cmimi
3AP1531216	1/2" x 16	10	-
3AP1531218	1/2" x 18	10	-
3AP1531220	1/2" x 20	10	-
3AP1533420	3/4" x 20	10	-
3AP1533426	3/4" x 26	5	-
3AP1530126	1" x 26	5	-
3AP1530132	1" x 32	5	-
3AP1530263	2" x 63	2	-

Kapse per tub inox APSTX



Kodi	Permasat	Sasia	Cmimi
3APSTX16	Ø16	25	-
3APSTX18	Ø18	25	-
3APSTX20	Ø20	25	-
3APSTX26	Ø26	10	-
3APSTX32	Ø32	10	-
3APSTX40	Ø40	5	-
3APSTX50	Ø50	5	-
3APSTX63	Ø63	5	-

Rakord me presim Hollandez
art. AP 185



Kodi	Permasat	Sasia	Cmimi
3AP1851216	1/2" x 16	10	-
3AP1851218	1/2" x 18	10	-
3AP1851220	1/2" x 20	5	-
3AP1853416	3/4" x 16	10	-
3AP1853420	3/4" x 20	5	-
3AP1850126	1" x 26	5	-
3AP1850132	1" x 32	5	-

Brryl tek me presim per stafe art.
AP 54A



Kodi	Permasat	Sasia	Cmimi
3AP54A1216	1/2" x 16	5	-
3AP54A1218	1/2" x 18	5	-
3AP54A1220	1/2" x 20	5	-
3AP54A3420	3/4" x 20	5	-

Stafe per brryla me flanaxhe
art. AP 49



Kodi	Permasat	Sasia	Cmimi
3AP493001	153/76,5	10	-

Brryl doppio me presim per stafe 90°
art. AP 54B



Kodi	Permasat	Sasia	Cmimi
3AP54B1218	18 x 1/2" x 18	5	-
3AP54B1220	20 x 1/2" x 20	5	-

Stafe art. AP 54



Kodi	Permasat	Sasia	Cmimi
3AP493000	153/80	10	-

Saracineske me prese incaso
art. AP 136C



Kodi	Permasat	Sasia	Cmimi
3AP1361616C	16 x 16	2	-
3AP1362020C	20 x 20	2	-

Brryl me presim me flanaxhe
art. AP 154



Kodi	Permasat	Sasia	Cmimi
3AP1541216	1/2" x 16	5	-
3AP1541218	1/2" x 18	5	-
3AP1541220	1/2" x 20	5	-

Brryl me presim me fllanxhe
art. AP 154L



Kodi	Permasat	Sasia	Cmimi
3AP154L1216	1/2" x 16	5	-
3AP154L1218	1/2" x 18	5	-
3AP154L1220	1/2" x 20	5	-

Brryl dopio me presim me fllanxhe
art. AP 154D



Kodi	Permasat	Sasia	Cmimi
3AP1541216D	16 x 1/2" x 16	5	-
3AP1541218D	18 x 1/2" x 18	5	-
3AP1541220D	20 x 1/2" x 20	5	-

TI dopio me presim per stafe 165°
art. AP 54C



Kodi	Permasat	Sasia	Cmimi
3AP54C1216	16 x 1/2" x 16	5	-
3AP54C1218	18 x 1/2" x 18	5	-
3AP54C1220	20 x 1/2" x 20	5	-

Aksesore per saracineske
art. AP 136C



Kodi	Pershkrimi	Sasia	Cmimi
3AP136CON-C	Me rozetë	1	-
		-	-
		-	-

Stafe me brryla me prese per grup dushi
art. AP 492



Kodi	Permasat	Sasia	Cmimi
3AP4921216	1/2" x 16	2	-
3AP4921218	1/2" x 18	2	-
3AP4921220	1/2" x 20	2	-

Brryl me presim Hollandez
art. AP 187



Kodi	Permasat	Sasia	Cmimi
3AP1873420	3/4" x 20	10	-
		-	-
		-	-

Zgjatues per art. AP136C



Kodi	Pershkrimi	Sasia	Cmimi
3AP136PR12C	Zgjatues	2	-

**Rakord mashkull me prese
ARL100**

Kodi	Permasat	Sasia	Cmimi
ARL1003100	1/2" x 16	10	-
ARL1003800	1/2" x 18	10	-
ARL1003200	1/2" x 20	10	-
ARL1004200	3/4" x 20	10	-
ARL1004300	3/4" x 26	5	-
ARL1010300	1" x 26	5	-
ARL1010400	1" x 32	5	-

**Rakord femer me prese
AEL110**

Kodi	Permasat	Sasia	Cmimi
ARL1103100	1/2" 16	10	-
ARL1103800	1/2" x 18	10	-
ARL1103200	1/2" x 20	10	-
ARL1104200	3/4" x 20	10	-
ARL1104300	3/4" x 26	5	-
ARL1110300	1" x 26	5	-
ARL1110400	1" x 32	5	-

**Bashkues me prese
ARL120**

Kodi	Permasat	Sasia	Cmimi
ARL1200110	16 x 16	10	-
ARL1200880	18 x 18	10	-
ARL1200220	20 x 20	10	-
ARL1200330	26 x 26	5	-
ARL1200440	32 x 32	5	-

**Reduksion me prese
ARL130**

Kodi	Permasat	Sasia	Cmimi
ARL1300210	20 x 16	10	-
ARL1300310	26 x 16	5	-
ARL1300320	26 x 20	5	-
ARL1300430	32 x 26	5	-
			-
			-

**Ti e reduktuar me prese
ARL240**

Kodi	Permasat	Sasia	Cmimi
ARL2400121	16 x 20 x 16	10	-
ARL2400211	20 x 16 x 16	10	-
ARL2400212	20 x 16 x 20	10	-
ARL2400221	20 x 20 x 16	10	-
ARL2400313	26 x 16 x 26	5	-
ARL2400322	26 x 20 x 20	5	-

**Ti e reduktuar me prese
ARL240**

Kodi	Permasat	Sasia	Cmimi
ARL2400323	26 x 20 x 26	5	-
ARL2400332	26 x 26 x 20	5	-
ARL2400434	32 x 26 x 32	5	-
ARL2400443	32 x 32 x 26	5	-
ARL2400424	32 x 20 x 32	5	-
ARL2400433	32 x 26 x 26	5	-

Ti me prese
 ARL220

Kodi	Permasat	Sasia	Cmimi
ARL2200111	16 x 16 x 16	10	-
ARL2200888	18 x 18 x 18	10	-
ARL2200222	20 x 20 x 20	10	-
ARL2200333	26 x 26 x 26	5	-
ARL2200444	32 x 32 x 32	5	-

 Ti me prese femer
 ARL210

Kodi	Permasat	Sasia	Cmimi
ARL2103101	16 x 1/2" x 16	10	-
ARL2103202	20 x 1/2" x 20	10	-
ARL2104202	20 x 3/4" x 20	10	-
ARL2104303	26 x 3/4" x 26	5	-
ARL2110404	32 x 1" x 32	5	-

 Ti me prese mashkull
 ARL200

Kodi	Permasat	Sasia	Cmimi
ARL2003101	16 x 1/2" x 16	10	-
ARL2004202	20 x 3/4" x 20	10	-
ARL2004303	26 x 3/4" x 26	5	-
ARL2010404	32 x 1" x 32	5	-

 Brryl me prese
 ARL320

Kodi	Permasat	Sasia	Cmimi
ARL3200110	16 x 16	10	-
ARL3200880	18 x 18	10	-
ARL3200220	20 x 20	10	-
ARL3200330	26 x 26	5	-
ARL3200440	32 x 32	5	-

 Brryl me prese femer
 ARL310

Kodi	Permasat	Sasia	Cmimi
ARL3103100	1/2" x 16	10	-
ARL3103800	1/2" x 18	10	-
ARL3103200	1/2" x 20	10	-
ARL3104200	3/4" x 20	10	-
ARL3104300	3/4" x 26	5	-
ARL3110400	1" x 32	5	-

 Brryl me prese mashkull
 ARL300

Kodi	Permasat	Sasia	Cmimi
ARL3003100	1/2" x 16	10	-
ARL3003800	1/2" x 18	10	-
ARL3003200	1/2" x 20	10	-
ARL3004200	3/4" x 20	10	-
ARL3004300	3/4" x 26	5	-
ARL3010400	1" x 32	5	-

Brryl me prese me fllanxhe femer
 ARL350



Kodi	Permasat	Sasia	Cmimi
ARL3503100	1/2" x 16	5	-
ARL3503800	1/2" x 18	5	-
ARL3503200	1/2" x 20	5	-

Tape me prese
 ARL710



Kodi	Permasat	Sasia	Cmimi
ARL7100100	16x 2	10	-
ARL7100800	18x 2	10	-
ARL7100200	20x 2	10	-
ARL7100300	26x 3	5	
ARL7100400	32x 3	5	

Brryl doppio me prese me fllanxhe
 ARL370



Kodi	Permasat	Sasia	Cmimi
ARL3703100	1/2" x 16	5	-
ARL3703200	1/2" x 20	5	-

Saracineske me prese incaso
 ARL600



Kodi	Permasat	Sasia	Cmimi
ARL3703100	16 x 16	2	-
ARL3703200	20 x 20	2	-

Stafe me brryla me prese me grup dushi
 ARL380



Kodi	Permasat	Sasia	Cmimi
ARL3803100	1/2" x 16	2	-

Stafe
 3AP49



Kodi	Permasat	Sasia	Cmimi
3AP493001	153/76.5	10	-

Rakord mashkull me shtrengim
 art.701 L

Kodi	Permasat	Sasia	Cmimi
3701L01216	1/2" x 16	10	-
3701L01218	1/2" x 18	10	-
3701L01220	1/2" x 20	10	-
3701L03416	3/4" x 16	10	-
3701L03418	3/4" x 18	10	-
3701L03420	3/4" x 20	10	-
3701L03426	3/4" x 26	5	-
3701L00126	1" x 26	5	-
3701L00132	1" x 32	5	-
3701L11432	1"1/4 x 32	5	-

 Rakord me shtrengim me heqje
 femer art.702 L

Kodi	Permasat	Sasia	Cmimi
3702L01216	1/2" x 16	10	-
3702L01218	1/2" x 18	10	-
3702L01220	1/2" x 20	10	-
3702L03416	3/4" x 16	10	-
3702L03418	3/4" x 18	10	-
3702L03420	3/4" x 20	10	-
3702L03426	3/4" x 26	5	-
3702L00126	1" x 26	5	-
3702L00132	1" x 32	5	-

 Bashkues me shtrengim me heqje
 art.703 L

Kodi	Permasat	Sasia	Cmimi
3703L01616	16 x 16	10	-
3703L01818	18 x 18	10	-
3703L02020	20 x 20	10	-
3703L02626	26 x 26	5	-
3703L03232	32 x 32	5	-
3703L02016	20 x 16	10	-
3703L02620	26 x 20	5	-
3703L03226	32 x 26	5	-

 Ti me shtrengim i reduktuar
 art.731L

Kodi	Permasat	Sasia	Cmimi
37TL161816	16 x 18 x 16	10	-
37TL162016	16 x 20 x 16	10	-
37TL181616	18 x 16 x 16	10	-
37TL181816	18 x 18 x 16	10	-
37TL201616	20 x 16 x 16	10	-
37TL201620	20 x 16 x 20	10	-
37TL202016	20 x 20 (x16)	10	-
37TL261818	26 x 18 x 18	5	-
37TL262020	26 x 20 x 20	5	-
37TL262026	26 x 20 x 26	5	-

 Ti me shtrengim i reduktuar
 art.731L

Kodi	Permasat	Sasia	Cmimi
37TL262620	26 x 26 x 20	5	-
37TL322632	32 x 26 x 32	5	-

 Ti me shtrengim me heqje
 art.731 L

Kodi	Permasat	Sasia	Cmimi
37TL161616	16 x 16 x 16	10	-
37TL181818	18 x 18 x 18	10	-
37TL202020	20 x 20 x 20	10	-
37TL262626	26 x 26 x 26	5	-
37TL323232	32 x 32 x 32	5	-

Ti me shtrengim femer
 art.732 L

Kodi	Permasat	Sasia	Cmimi
3732L01216	16 x 1/2" x 16	10	-
3732L01218	18 x 1/2" x 18	10	-
3732L01220	20 x 1/2" x 20	10	-
3732L03418	18 x 3/4" x 18	10	-
3732L03420	20 x 3/4" x 20	10	-
3732L03426	26 x 3/4" x 26	5	-
3732L00132	32 x 1" x 32	5	-

 Ti me shtrengim mashkull
 art.733 L

Kodi	Permasat	Sasia	Cmimi
3733L01216	16 x 1/2" x 16	10	-
3733L01218	18 x 1/2" x 18	10	-
3733L01220	20 x 1/2" x 20	10	-
3733L03418	18 x 3/4" x 18	10	-
3733L03420	20 x 3/4" x 20	10	-
3733L03426	26 x 3/4" x 26	5	-
3733L00132	32 x 1" x 32	5	-

 Brryl me shtrengim me heqje
 art.751 L

Kodi	Permasat	Sasia	Cmimi
3751L01616	16 x 16	10	-
3751L01818	18 x 18	10	-
3751L02020	20 x 20	10	-
3751L02626	26 x 26	5	-
3751L03232	32 x 32	5	-

 Brryl me shtrengim femer me heqje
 art.752 L

Kodi	Permasat	Sasia	Cmimi
3752L01216	1/2" x 16	10	-
3752L01218	1/2" x 18	10	-
3752L01220	1/2" x 20	10	-
3752L03418	3/4" x 18	10	-
3752L03420	3/4" x 20	10	-
3752L03426	3/4" x 26	5	-
3752L00126	1" x 26	5	-
3752L00132	1" x 32	5	-

 Brryl me shtrengim mashkull me heqje
 art.753 L

Kodi	Permasat	Sasia	Cmimi
3753L01216	1/2" x 16	10	-
3753L01218	1/2" x 18	10	-
3753L01220	1/2" x 20	10	-
3753L03418	3/4" x 18	10	-
3753L03420	3/4" x 20	10	-
3753L03426	3/4" x 26	5	-
3753L00126	1" x 26	5	-
3753L00132	1" x 32	5	-
3753L11432	1" 1/4 x 32	5	-

 Buketon per rakord
 art.780 L

Kodi	Permasat	Sasia	Cmimi
3780L01620	16	10	-
3780L01820	18	10	-
3780L02020	20	10	-
3780L02630	26	10	-
3780L03230	32	5	-

Brryll me shtrengim me fllanxhe
 art. 754 L

 Rakord me shtrengim mashkull
 art. 701 F

 Rakord me shtrengim mashkull
 art. 701 FP-EN 10226

Kodi	Permasat	Sasia	Cmimi
3754L01216	1/2" x 16	10	-
3754L01218	1/2" x 18	10	-
3754L01220	1/2" x 20	10	-

Kodi	Permasat	Sasia	Cmimi
3701F121620	1/2" x 16	10	-
3701F122020	1/2" x 20	10	-
3701F341620	3/4" x 16	10	-
3701F342020	3/4" x 20	10	-
3701F342630	3/4" x 26	5	-
3701F012630	1" x 26	5	-

Kodi	Permasat	Sasia	Cmimi
3701FP121620	1/2" x 16	10	-
3701FP122020	1/2" x 20	10	-
3701FP341620	3/4" x 16	10	-
3701FP342020	3/4" x 20	10	-
3701FP342630	3/4" x 26	5	-
3701FP012630	1" x 26	5	-

 Rakord me shtrengim femer
 art. 702 F

 Rakord me shtrengim femer
 art. 702 FP-EN 10226

 Bashkues me shtrengim
 art. 703 F

Kodi	Permasat	Sasia	Cmimi
3702F121620	1/2" x 16	10	-
3702F122020	1/2" x 20	10	-
3702F341620	3/4" x 16	10	-
3702F342020	3/4" x 20	10	-
3702F342630	3/4" x 26	5	-
3702F012630	1" x 26	5	-

Kodi	Permasat	Sasia	Cmimi
3702FP121620	1/2" x 16	10	-
3702FP122020	1/2" x 20	10	-
3702FP341620	3/4" x 16	10	-
3702FP342020	3/4" x 20	10	-
3702FP342630	3/4" x 26	5	-
3702FP012630	1" x 26	5	-

Kodi	Permasat	Sasia	Cmimi
3703F001616	16 x 16	10	-
3703F002020	20 x 20	10	-
3703F002626	26 x 26	5	-
3703F002016	20 x 16	10	-
3703F002620	26 x 20	5	-



SERIA 700F, RAKORDERI TE NIKELUAR ME SHTRENGIM ME TRUP TE VETEM PER TUBA MULTISTRAT

Ti e reduktuar me shtrengim
art. 731 F



Ti me shtrengim
art. 731 F



Brryl me shtrengim
art. 751 F



Kodi	Permasat	Sasia	Cmimi
37TF162016	16 x 20 x 16	10	-
37TF201616	20 x 16 x 16	10	-
37TF201620	20 x 16 x 20	10	-
37TF202016	20 x 20 x 16	10	-
37TF262026	26 x 20 x 26	5	-
37TF262620	26 x 26 x 20	5	-

Kodi	Permasat	Sasia	Cmimi
37TF161616	16 x 16 x 16	10	-
37TF202020	20 x 20 x 20	10	-
37TF262626	26 x 26 x 26	5	-

Kodi	Permasat	Sasia	Cmimi
3751F001616	16 x 16	10	-
3751F002020	20 x 20	10	-
3751F002626	26 x 26	5	-

Ti me shtrengim femer
art. 732 F



Ti me shtrengim femer
art. 732 FP - EN 10226



Ti me shtrengim mashkull
art. 733 F



Kodi	Permasat	Sasia	Cmimi
3732F121620	16 x 1/2" x 16	10	-
3732F122020	20 x 1/2" x 20	10	-
3732F342020	20 x 3/4" x 20	10	-
3732F342630	26 x 3/4" x 26	5	-

Kodi	Permasat	Sasia	Cmimi
3732FP121620	16 x 1/2" x 16	10	-
3732FP122020	20 x 1/2" x 20	10	-
3732FP341620	16 x 3/4" x 16	10	-
3732FP342020	20 x 3/4" x 20	10	-
3732FP342630	26 x 3/4" x 26	5	-
3732FP012630	26 x 1" x 26	5	-

Kodi	Permasat	Sasia	Cmimi
3733F121620	16 x 1/2" x 16	10	-
3733F122020	20 x 1/2" x 20	10	-
3733F342020	20 x 3/4" x 20	10	-
3733F342630	26 x 3/4" x 26	5	-

Panele Diellore

Ngrhje & Ftohje

Hidraulike

Hidrosanitare

Aksesore të ndryshëm

Ti me shtrengim mashkull
 art. 733 FP-EN 10226

Kodi	Permasat	Sasia	Cmimi
3733FP121620	16 x 1/2" x 16	10	-
3733FP122020	20 x 1/2" x 20	10	-
3733FP342020	20 x 3/4" x 20	10	-
3733FP342630	26 x 3/4" x 26	5	-

 Brryl me shtrengim femer
 art. 752 F

Kodi	Permasat	Sasia	Cmimi
3752F121620	1/2" x 16	10	-
3752F122020	1/2" x 20	10	-
3752F342020	3/4" x 20	10	-
3752F342630	3/4" x 26	5	-

 Brryl me shtrengim femer
 art. 752 FP - EN 10226

Kodi	Permasat	Sasia	Cmimi
3752FP121620	1/2" x 16	10	-
3752FP122020	1/2" x 20	10	-
3752FP341620	3/4" x 16	10	-
3752FP342020	3/4" x 20	10	-
3752FP342630	3/4" x 26	5	-
3752FP012630	1" x 26	5	-

 Brryl me shtrengim mashkull
 art. 753 F

Kodi	Permasat	Sasia	Cmimi
3753F121620	1/2" x 16	10	-
3753F122020	1/2" x 20	10	-
3753F342020	3/4" x 20	10	-
3753F342630	3/4" x 26	5	-

 Brryl me shtrengim mashkull
 art. 753 FP-UNI 10226

Kodi	Permasat	Sasia	Cmimi
3753FP121620	1/2" x 16	10	-
3753FP122020	1/2" x 20	10	-
3753FP341620	3/4" x 16	10	-
3753FP342020	3/4" x 20	10	-
3753FP342630	3/4" x 26	5	-
3753FP012630	1" x 26	5	-

 Brryl me shtrengim femer
 art. 752 F

Kodi	Permasat	Sasia	Cmimi
3753F121620	1/2" x 16	10	-
3753F122020	1/2" x 20	10	-
3753F342020	3/4" x 20	10	-
3753F342630	3/4" x 26	5	-

Brryl me shtrengim femer
art. 752 FP - EN 10226



Kodi	Permasat	Sasia	Cmimi
3752FP121620	1/2" x 16	10	-
3752FP122020	1/2" x 20	10	-
3752FP341620	3/4" x 16	10	-
3752FP342020	3/4" x 20	10	-
3752FP342630	3/4" x 26	5	-
3752FP012630	1" x 26	5	-

Brryl me shtrengim mashkull
art. 753 F



Kodi	Permasat	Sasia	Cmimi
3753F121620	1/2" x 16	10	-
3753F122020	1/2" x 20	10	-
3753F342020	3/4" x 20	10	-
3753F342630	3/4" x 26	5	-

Brryl me shtrengim mashkull
art. 753 FP - UNI10226



Kodi	Permasat	Sasia	Cmimi
3753FP121620	1/2" x 16	10	-
3753FP122020	1/2" x 20	10	-
3753FP341620	3/4" x 16	10	-
3753FP342020	3/4" x 20	10	-
3753FP342630	3/4" x 26	5	-
3753FP012630	1" x 26	5	-

Brryl me shtrengim me flanaxhe
art. 754 F



Kodi	Permasat	Sasia	Cmimi
3754F121620	1/2" x 16	10	-
3754F122020	1/2" x 20	10	-

Brryl me shtrengim me flanaxhe
art. 754 FP - UNI10226



Kodi	Permasat	Sasia	Cmimi
3754FP121620	1/2" x 16	10	-
3754FP122020	1/2" x 20	10	-
3754FP341620	3/4" x 16	10	-
3754FP342020	3/4" x 20	10	-

Brryl me shtrengim per gup dushi me stafe
art. 792 F



Kodi	Permasat	Sasia	Cmimi
3792F121620	1/2" x 16	2	-

Zgjatues bronzi i kromuar
 art.197

Kodi	Permasat	Sasia	Cmimi
31971210N	1/2" x 10	10	-
31971215N	1/2" x 15	10	-
31971220N	1/2" x 20	10	-
31971225N	1/2" x 25	10	-
31971230N	1/2" x 30	10	-

 Reduksion bronzi MM
 art.580

Kodi	Permasat	Sasia	Cmimi
35803814N	3/8" x 1/4"	10	-
35801238N	1/2" x 3/8"	10	-
35803412N	3/4" x 1/2"	10	-
35800134N	1" x 3/4"	10	-

 Reduksion bronzi
 MF art.581

Kodi	Permasat	Sasia	Cmimi
35811238N	1/2" x 3/8"	10	-
35813438N	3/4" x 3/8"	10	-
35813412N	3/4" x 1/2"	10	-
35810112N	1" x 1/2"	10	-
35810134N	1" x 3/4"	10	-
35810114N	1" 1/4 x 1"	10	-
35811438N	1" 1/4 x 3/8"	10	-

 Nipel bronzi MM
 art.582

Kodi	Permasat	Sasia	Cmimi
35823838N	3/8" x 3/8"	10	-
35821212N	1/2" x 1/2"	10	-
35823434N	3/4" x 3/4"	10	-
35820101N	1" x 1"	10	-
35820114N	1" 1/4 x 1" 1/4	5	-
35820112N	1" 1/2 x 1" 1/2	5	-

 Tape bronzi mashkull
 art.583

Kodi	Permasat	Sasia	Cmimi
35830014N	1/4"	10	-
35830038N	3/8"	10	-
35830012N	1/2"	10	-
35830034N	3/4"	10	-
35830001N	1"	10	-

 Tape bronzi femer
 art.590

Kodi	Permasat	Sasia	Cmimi
35900038N	3/8"	10	-
35900012N	1/2"	10	-
35900034N	3/4"	10	-
35900001N	1"	10	-

 Reduksion bronzi FF
 art.591

Kodi	Permasat	Sasia	Cmimi
35911238N	1/2" x 3/8"	10	-
35913438N	3/4" x 3/8"	10	-
35913412N	3/4" x 1/2"	10	-

 Reduksion bronzi FM
 art.592

Kodi	Permasat	Sasia	Cmimi
35923838N	3/8" x 3/8"	10	-
35921238N	1/2" x 3/8"	10	-
35923412N	3/4" x 1/2"	10	-
35920134N	1" x 3/4"	10	-

 Manikote bronzi FF
 art.270

Kodi	Permasat	Sasia	Cmimi
A2700038N	3/8"	10	-
A2700012N	1/2"	10	-
A2700034N	3/4"	10	-
A2700001N	1"	10	-

Manikote e reduktuar
 FF art. 240

Kodi	Permasat	Sasia	Cmimi
A2400134N	3/8"	10	-

Ti bronzi FFF art. 130



Kodi	Permasat	Sasia	Cmimi
A1300038N	3/8"	10	-
A1300012N	1/2"	10	-
A1300034N	3/4"	10	-
A1300001N	1"	5	-

Brryl bronzi FF art. 90



Kodi	Permasat	Sasia	Cmimi
A0900012N	1/2" x 1/2"	10	-
A0900034N	3/4" x 3/4"	10	-
A0900001N	1" x 1"	5	-

 Brryl bronzi MF
 art. 92

Kodi	Permasat	Sasia	Cmimi
A0920012N	1/2" x 1/2"	10	-
A0920034N	3/4" x 3/4"	10	-
A0920001N	1" x 1"	5	-

 Brryl bronzi MM
 art. 93

Kodi	Permasat	Sasia	Cmimi
A0930012N	1/2" x 1/2"	10	-
A0930034N	3/4" x 3/4"	10	-
A0930001N	1" x 1"	5	-

 Unaze e filetuar bronzi
 art. 99

Kodi	Permasat	Sasia	Cmimi
A0991238N	1/2" x 3/8"	10	-
A0993412N	3/4" x 1/2"	10	-
A0990134N	1" x 3/4"	10	-

 Nipel bronzi me unaze
 art. 582 CO

Kodi	Permasat	Sasia	Cmimi
3582C034N	3/4" x 3/4"	10	-
3582C001N	1" x 1"	10	-

 Filter bronzi Y
 art. 3FIL

Kodi	Permasat	Sasia	Cmimi
3FIL12	1/2"	20	-
3FIL34	3/4"	10	-
3FIL01	1"	6	-

Hollandez bronzi MF
 art.341

 Hollandez bronzi me unaze
 MF art.341 CO

 Brryl bronzi me hollandez MF
 art.98

Kodi	Permasat	Sasia	Cmimi
30410012	1/2" x 1/2"	10	-
30410034	3/4" x 3/4"	10	-
30410001	1" x 1"	5	-

Kodi	Permasat	Sasia	Cmimi
3041CO12	1/2" x 1/2"	10	-
3041CO34	3/4" x 3/4"	10	-
3041CO01	1" x 1"	5	-
3041CO04	1"1/4 x 1"1/4	5	-

Kodi	Permasat	Sasia	Cmimi
30980012	1/2" x 1/2"	10	-
30980034	3/4" x 3/4"	10	-
30980001	1" x 1"	5	-

 Brryl bronzi me hollandez me unaze
 MF art.98 CO

 Valvul e nikeluar
 art.860

Kodi	Permasat	Sasia	Cmimi
3098CO12	1/2" x 1/2"	10	-
3098CO34	3/4" x 3/4"	10	-
3098CO01	1" x 1"	5	-
3098CO04	1"1/4 x 1"1/4	5	-

Kodi	Permasat	Sasia	Cmimi
88600038	3/8 CH. 17	100	-

Kolektor per systemin ngrohje
dysHEMEJE 1" 1/4

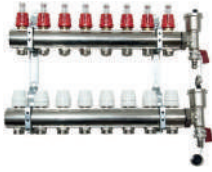

Kolektor 1" FF art.990



Kolektor 1" FF art.990



Kodi	Permasat	Menyra	Cmimi
394107	1"1/4x3/4"	7+7	-
394108	1"1/4x3/4"	8+8	-
394109	1"1/4x3/4"	9+9	-
394110	1"1/4x3/4"	10+10	-
394111	1"1/4x3/4"	11+11	-
394112	1"1/4x3/4"	12+12	-
394113	1"1/4x3/4"	13+13	-

Kodi	Permasat	Menyra	Cmimi
39902134	1" x 3/4"	2	-
39903134	1" x 3/4"	3	-
39904134	1" x 3/4"	4	-
39905134	1" x 3/4"	5	-
39906134	1" x 3/4"	6	-
39907134	1" x 3/4"	7	-
39908134	1" x 3/4"	8	-

Kodi	Permasat	Menyra	Cmimi
39909134	1" x 3/4"	9	-
39910134	1" x 3/4"	10	-
39911134	1" x 3/4"	11	-
39912134	1" x 3/4"	12	-
39913134	1" x 3/4"	13	-

Kolektor bronzi MF da 3/4" me
mbyllje a 35° e derivim 1/2" M art.
790 A me unaze



Kolektor bronzi MF da 1" me
mbyllje a 35° e derivim 3/4" M
eurocono art. 790 B me unaze



Kolektor bronzi MF da 3/4"
me mbyllje 35° e derivim
1/2" M blu



Kodi	Permasat	Menyra	Cmimi
37902L3400	3/4" x 1/2"	2	-
37903L3400	3/4" x 1/2"	3	-
37904L3400	3/4" x 1/2"	4	-

Kodi	Permasat	Menyra	Cmimi
37902L0100	1" x 3/4"	2	-
37903L0100	1" x 3/4"	3	-
37904L0100	1" x 3/4"	4	-

Kodi	Permasat	Menyra	Cmimi
AC79154302B	3/4" x 1/2"	2	-
AC79154303B	3/4" x 1/2"	3	-
AC79154304B	3/4" x 1/2"	4	-

Kolektor bronzi MF da 1" me mbyllje 35° e derivim 3/4" M eurocono I kuq



Kodi	Permasat	Menyra	Cmimi
AC79154302R	3/4" x 1/2"	2	-
AC79154303R	3/4" x 1/2"	3	-
AC79154304R	3/4" x 1/2"	4	-

Kolektor bronzi MF da 3/4" me bukaton 781L art. 880



Kodi	Permasat	Menyra	Cmimi
37882L3416M	3/4" x 16	2	-
37883L3416M	3/4" x 16	3	-
37884L3416M	3/4" x 16	4	-
37885L3416M	3/4" x 16	5	-
37886L3416M	3/4" x 16	6	-

Buketon bronzi 3/4" per tub multistrato art.985 M



Kodi	Permasat	Sasia	Cmimi
3985M341620	3/4" x 16	10	-
3985M341720	3/4" x 17	10	-
3985M341820	3/4" x 18	10	-
3985M342020	3/4" x 20	10	-

Buketon bronzi da 3/4" per tub plastike art. 985P



Kodi	Permasat	Sasia	Cmimi
3985P341525	3/4" x 15	10	-
3985P341620	3/4" x 16	10	-
3985P341720	3/4" x 17	10	-
3985P341820	3/4" x 18	10	-
3985P342020	3/4" x 20	10	-

Buketon kolektori 1/2" per tub multistrato art. 781 L



Kodi	Permasat	Sasia	Cmimi
3781L01420	1/2" x 14	10	-
3781L01620	1/2" x 16	10	-

Buketon kolektori da 1/2" per tub plastik art. 781 P



Kodi	Permasat	Sasia	Cmimi
3781P01525	1/2" x 15	10	-
3781P01620	1/2" x 16	10	-

Rakord me hollandez me prese art. AP 185



Kodi	Permasat	Sasia	Cmimi
3AP1851216	1/2" x 16	10	-
3AP1851218	1/2" x 18	10	-
3AP1851220	1/2" x 20	5	-
3AP1853416	3/4" x 16	10	-
3AP1853420	3/4" x 20	5	-

Buketon kolektori FASTEC per tubo multistrato



Kodi	Permasat	Sasia	Cmimi
ACA8000100	16	10	-
ACA8000200	20	10	-
ACA8000300	26	5	-

**2.1 TUB MULTISTRAT I DREJTE / GJATESIA
PeXb/Al/PeXb**

Kodi	Permasat	Gjatesia(m)	Sasia (m)	Sasia (no)	Cmimi
9MN021620BR	16x2.0	4	80	20	-
9MN031820BR	18x2.0	4	80	20	-
9MN032020BR	20x2.0	4	40	10	-
9MN042630BR	26x3.0	4	40	10	-
9MN453230BR	32x3.0	4	32	8	-

**2.1 TUB MULTISTRAT I DREJTE PA VESHJE
/ PeXc/AL/PeXc**

Kodi	Permasat	Gjatesia(m)	Sasia (m)	Sasia (no)	Cmimi
9MN454040BR	40x4.0	4	36	9	-
9MN455045BR	50x4.5	4	28	7	-
9MN456345BR	63x4.5	4	16	4	-

**2.2 TUB MULTISTRAT I VESHUR GRI PeXb/Al/PeXb
Per ngrohje dhe uje te ngrohje sanitar**

Kodi	Permasat	Veshja(mm)	GJ.spirales (m)	Cmimi
9MR02162050F	16x2.0	6	50	-
9MR021620100F	16x2.0	6	100	-
9MR03182050F	18x2.0	6	50	-
9MR03202050F	20x2.0	9	50	-
9MR02202050SF	20x2.0*	6	50	-
9MR04263050F	26x3.0	9	50	-
9MR45323025F	32x3.0	9	25	-

**2.2 TUB MULTISTRAT I VESHUR I KUQ /PeXb/Al/PeXb
Per ngrohje dhe sisteme hidraulike .**

Kodi	Permasat	Veshja(mm)	GJ.spirales (m)	Cmimi
9MR02162050FR	16x2.0	6	50	-
9MR021620100FR	16x2.0	6	100	-
9MR03202050FR	20x2.0	9	50	-
9MR02202050SFR	20x2.0*	6	50	-
9MR04263050FR	26x3.0	9	50	-
9MR45323025FR	32x3.0	9	25	-

**2.2 TUB MULTISTRAT I VESHUR BLU /PeXb/Al/PeXb
Per ngrohje dhe sisteme hidraulike**

Kodi	Permasat	Veshja(mm)	GJ.spirales (m)	Cmimi
9MR02162050FB	16x2.0	6	50	-
9MR021620100FB	16x2.0	6	100	-
9MR03202050FB	20x2.0	9	50	-
9MR02202050SFB	20x2.0*	6	50	-
9MR04263050FB	26x3.0	9	50	-
9MR45323025FB	32x3.0	9	25	-

**2.2 TUB MULTISTRAT I VESHUR I BARDHE PeXb/Al/PeXb
Per sisteme kondicionimi .**

Kodi	Permasat	Veshja(mm)	GJ.spirales (m)	Cmimi
9MRC02162050F	16x2.0	10	50	-
9MRC03202050F	20x2.0	13	50	-
9MRC04263050F	26x3.0	13	50	-
9MRC45323025F	32x3.0	13	25	-

**3.1 RAKORD MASHKULLI I DREJTE
AP 601**

**3.1 RAKORD FEMER I DREJTE
AP 602**

**3.1 BASHKUES I DREJTE ME PRESE
AP 603**

Kodi	Permasat	Sasia	Cmimi
3AP6011216	1/2" x 16	10	-
3AP6011220	1/2" x 20	10	-
3AP6013420	3/4" x 20	10	-
3AP6013426	3/4" x 26	5	-
3AP6013432	3/4" x 32	5	-
3AP6010126	1" x 26	5	-
3AP6010132	1" x 32	5	-

Kodi	Permasat	Sasia	Cmimi
3AP6021216	1/2" x 16	10	-
3AP6021220	1/2" x 20	10	-
3AP6023420	3/4" x 20	10	-
3AP6023426	3/4" x 26	5	-

Kodi	Permasat	Sasia	Cmimi
3AP6031616	16 x 2 x 16	10	-
3AP6032020	20 x 2 x 20	10	-
3AP6032626	26 x 2 x 26	5	-
3AP6033232	32 x 2 x 32	5	-

**3.1 REDUKSION I DREJTE ME PRESE
AP 603**

**3.1 90°Ti
AP 631**

**3.1 Ti e reduktuar
AP 631**

Kodi	Permasat	Sasia	Cmimi
3AP6032016	20 x 2 x 16	10	-
3AP6032620	26 x 3 x 20	5	-
3AP6033226	32 x 3 x 26	5	-

Kodi	Permasat	Sasia	Cmimi
3AP631161616	16x16x16	10	-
3AP631202020	20x20x20	10	-
3AP631262626	26x26x26	5	-

Kodi	Permasat	Sasia	Cmimi
3AP631201616	20x16x16	10	-
3AP631201620	20x16x20	10	-
3AP631202016	20x20x16	10	-
3AP631261626	26x16x26	5	-
3AP631262020	26x20x20	5	-
3AP631262026	26x20x26	5	-

**3.1 TI ME PRESE FEMER
AP 632**

**3.1 90°BRRYL
AP 651**

**3.1 BRRYL ME PRESE FEMER
P 652**

Kodi	Permasat	Sasia	Cmimi
3AP6321216	16x1/2"x16	10	-
3AP6321220	20x1/2"x20	10	-
3AP6323420	20x3/4"x20	10	-
3AP6323426	26x3/4"x26	5	-

Kodi	Permasat	Sasia	Cmimi
3AP6510016	16 x 2 x 16	10	-
3AP6510020	20 x 2 x 20	10	-
3AP6510026	26 x 3 x 26	5	-
3AP6510032	32 x 3 x 32	5	-

Kodi	Permasat	Sasia	Cmimi
3AP6521216	1/2"x16	10	-
3AP6521220	1/2"x20	10	-
3AP6523420	3/4"x20	10	-
3AP6523426	3/4"x26	5	-
3AP6520132	1"x32	5	-

**3.1 BRRYL ME PRESE MASHKULL
AP 653**

**3.1 BRRYL ME FLLANXHE
AP 654**

**3.1 RAKORD ME PRESE HOLLANDEZ
AP 685**

Kodi	Permasat	Sasia	Cmimi
3AP6531216	1/2"x16	10	-
3AP6531220	1/2"x20	10	-
3AP6533420	3/4"x20	10	-
3AP6533426	3/4"x26	5	-
3AP6530132	1"x32	5	-

Kodi	Permasat	Sasia	Cmimi
3AP6541216	1/2"x16	5	-
3AP6541220	1/2"x20	5	-

Kodi	Permasat	Sasia	Cmimi
3AP6851216	1/2"x16	10	-
3AP6851220	1/2"x20	5	-
3AP6853416	3/4"x16	10	-
3AP6853420	3/4"x20	5	-

3.2 TUB MULTIGAZ PeXb/Al/PeXb



Kodi	Permasat	GJ.spirales (m)	Cmimi
9CR02162050FG	16x2.0	50	-
9CR03202050FG	20x2.0	50	-
9CR04263050FG	26x3.0	50	-
9CR45323025FG	32x3.0	25	-

3.2 TUB MULTIGAZ PeXb/Al/PeXb ME IZOLIM

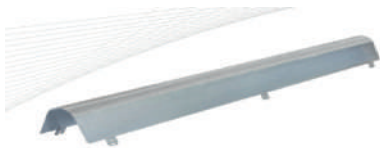
Kodi	Permasat	GJ.spirales (m)	Cmimi
9ST02162050FG	16 X 2.0	50	-
9ST03202050FG	20 X 2.0	50	-

3.2 KANAL METALI PËR TUBAT MULTIGAZ

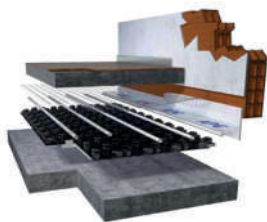
Kodi	Permasat	Cmimi
GAB0305075	75 x 5 cm	-
		-
		-
		-

4.1 NGROHJE RADIANTE NGA DYSHEMEJA
TOP SISTEMET

Kodi	Permasat	Sip. e paketes (m ²)	Cmimi
TI40402210	Ashlar panel TOP mm 1380X690X30H10/30EPS200	19,04	-
TI40402220	Ashlar panel TOP mm 1380X690X40H20/40EPS150	13,33	-
TI40402230	Ashlar panel TOP mm 1380X690X50H30/50EPS150	9,52	-
TI40402240	Ashlar panel TOP mm 1380X690X60H40/60EPS150	7,62	-
TI40402250	Ashlar panel TOP mm 1380X690X70H50/70EPS150	6,67	-

Kodi	IZOLIM I PANELIT			MBESHTJELLJA			TRASHESIA TOTALE	
	Baza e izolimit A (mm)	Skaj i poshtem B (mm)	TOT panel A+B (mm)	Traditional C ₁ (mm)	Self-levelling C ₂ (mm)	DysHEMEJA D (mm)	Traditional A+B+C+D (mm)	self-levelling A+B+C ₂ +D (mm)
TI40402210	10	20	30	45	30	10	85	70
TI40402210	20	20	40	45	30	10	95	80
TI40402210	30	20	50	45	30	10	105	90
TI40402210	40	20	60	45	30	10	115	100
TI40402210	50	20	70	45	30	10	125	110

4.2 Kolektor 1" i montuar paraprakisht për sistemin e ngrohjes me dysheme rrezatuese me matës të rrjedhës 940

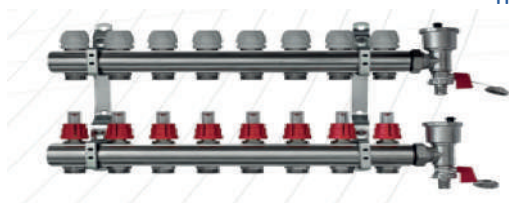

4.2 Kolektor i montuar paraprakisht 1" 1/4 për sistemin e ngrohjes me dysheme rrezatuese me matës të rrjedhës 941

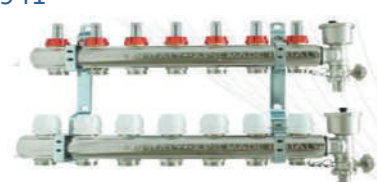

Kodi	Permasat	Menyra	Cmimi	Kodi	Permasat	Menyra	Cmimi	Kodi	Permasat	Menyra	Cmimi
394002	1"x3/4"	2+2	-	394009	1"x3/4"	9+9	-	394107	1"1/4x3/4"	7+7	-
394003	1"x3/4"	3+3	-	394010	1"x3/4"	10+10	-	394108	1"1/4x3/4"	8+8	-
394004	1"x3/4"	4+4	-	394011	1"x3/4"	11+11	-	394109	1"1/4x3/4"	9+9	-
394005	1"x3/4"	5+5	-	394012	1"x3/4"	12+12	-	394110	1"1/4x3/4"	10+10	-
394006	1"x3/4"	6+6	-	394013	1"x3/4"	13+13	-	394111	1"1/4x3/4"	11+11	-
394007	1"x3/4"	7+7	-				-	394112	1"1/4x3/4"	12+12	-
394008	1"x3/4"	8+8	-				-	394113	1"1/4x3/4"	13+13	-



APE THERM NJESI KONTROLLI

Njesia e kontrollit me pike fikse me Madhesi 1" me bypass

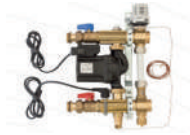

Kodi	Permasa	Cmimi
TC10100001	-	-

Njesia e kontrollit me pike fikse me Madhesi 1" me bypass



Kodi	Permasa	Cmimi
TC10100001	-	-

Kit 1"-1way A.T.



Kodi	Permasa	Cmimi
TC10300001	-	-
TC10300002	-	-
TC10300003	-	-

Panele Djellore

Ngrohje & Ftohje

Hidraulike

Hidrosanitare

Aksesore të ndryshëm

MULTIFAR

The one and only



BEWARE OF
IMITATIONS



Kit Hidraulik (pompe, valvol), ART.2171



Kodi	Pompa	Cmimi
21711130EA	Electronic 1-7 m	-
21711180E6	Electronic 1-6 m	-
21711180EA	Electronic 1-8 m	-
		-
		-

Filter uji per sistem kaldaje ART.2200



kodi	Permasat	Cmimi
22 0034	3/4"	-
2200 1	1"	-
2200 114	1"1/4	-
2200 112	1"1/2	-
2200 2	2"	-

Filter uji per sistem kaldaje me magnet ART.2205



Kodi	Permasat	Cmimi
2205 34	3/4"	-
2205 1	1"	-
2205 114	1"1/4	-
2205 112	1"1/2	-
2205 2	2"	-

Separator per kaldaje ART.2258



Kodi	Permasat	Cmimi
2258 50	DN50	-
2258 65	DN65	-
2258 80	DN80	-
2258 100	DN100	-
2258 125	DN125	-
2258 150	DN150	-

Manometer 10 ATM ART.2500



Kodi	Permasat	Cmimi
2500 R04	1/4"(0÷4bar)	-
2500 R06	1/4"(0÷6bar)	-
2500 R10	1/4"(0÷10bar)	-
2500 R25	1/4"(0÷25bar)	-
2500 P04	1/4"(0÷4bar)	-
2500 P06	1/4"(0÷6bar)	-
2500 P10	1/4"(0÷10bar)	-

Manometer presioni 25 ATM ART.2501



Kodi	Permasat	Cmimi
2501 R06	1/4"(0÷6bar)	-
2501 R10	1/4"(0÷10bar)	-
2501 R25	1/4"(0÷25bar)	-
		-
		-
		-

Filter uji per sisteme te ndryshme / krmomuar ART.2273



Kodi	Permasat	Cmimi
2273 34	3/4"	-

Automatik mbushes bronxi uje 1/2 M me tregues gradimi ART.2106



Kodi	Permasat	Cmimi
2106 12	1/2"	-

Kit me 3 dalje +manometer+cajrus +valvul 1" ART.2115



Kodi	Permasat	Cmimi
2115	1"	-



GRUPET E PRESIONIT DHE PJESET E KEMBIMIT

Termometer 80mm. 0-120°C ART.2600



Kodi	Permasat	Cmimi
2600	1/2''(0÷120°C)	-
2600 100	1/2''(0÷120°C)	-

Termomanometer 80mm. 0-4bar 0-120° ART.2550



Kodi	Shkalla presionit	Cmimi
2550 P04	0-4 bar(0÷120°C)	-
2550 P10	0-10 bar(0÷120°C)	-

Termometer 40mm 0-120° ART.2653



Kodi	Shkalla Temp.	Cmimi
2653 80	0-80°C	-
2653 120	0-120°C	-

Hidrostat kaldaje me tub ART.7956



Kodi	Box	Cmimi
7956	1	-

Thermostat ne distance ART.7953



Kodi	Box	Cmimi
7953	1	-

Balancues mekanik ART.2130



kodi	Permasat	Cmimi
2130112	1x1/2''	-
2130114	1x1/4''	-
21301	1''	-

Hidrostat kaldaje me 2 sonda +rregullues temperature ART.7952



Kodi	Box	Cmimi
7952	1	-

Sarçineske elektrike 3 rrugeshe 1.1/4"+3 hollandez ART.301220



kodi	Permasat	Cmimi
301220 12180	1/2''	-
301220 34180	3/4''	-
301220 1180	1''	-
301220 114180	1''1/4	-

Autobalancues per fancoil fi 3/4" 4bar ART. 2136



Kodi	Permasat	Cmimi
2136 12	1/2''	-
2136 34	3/4''	-
2136 1	1''	-
2136 114	1'' 1/4	-

Hidrostat kaldaje me suste ART.7951



Kodi	Box	Cmimi
7951	1	-

Çajrus bronxi - bronxi i nikeluar 1/2 M ART.2045 - 2050



kodi	Permasat	Cmimi
2045 38	3/8''	-
2045 12	1/2''	-
2045 34	3/4''	-
2050 38	3/8''	-
2050 12	1/2''	-
2050 34	3/4''	-

Motorr elektrik per autobalancues ART. 2138



Kodi	Box	Cmimi
2138 180	1	-



GRUPET E PRESIONIT DHE PJESET E KEMBIMIT

Valvul sigurie 3bar 1/2 M x 1/2
ART.2004



Kodi	Permasat	Cmimi
2004 121210	1/2"x1/2"(1bar)	-
2004 121215	1/2"x1/2"(1.5bar)	-
2004 121220	1/2"x1/2"(2bar)	-
2004 121225	1/2"x1/2"(2.5bar)	-
2004 121230	1/2"x1/2"(3bar)	-
2004 121235	1/2"x1/2"(3.5bar)	-
2004 121240	1/2"x1/2"(4bar)	-
2004 121250	1/2"x1/2"(5bar)	-

Rregullator presioni
ART. 0-2815



Kodi	Permasat	Cmimi
2815 12	1/2"	-
2815 34	3/4"	-
2815 1	1"	-
2815 114	1"1/4	-
2815 112	1"1/2	-
2815 2	2"	-

Filter uji per kaldaje pa
manometer ART. 3938



Kodi	Permasat	Cmimi
3938 34	3/4"	-
3938 1	1"	-
3938 114	1"1/4	-
3938 112	1"1/2	-
3938	2"	-

Valvul sigurie 3bar 1/2 M x 1/2
ART.2004



Kodi	Permasat	Cmimi
2004 121260	1/2"x1/2"(6bar)	-
2004 121270	1/2"x1/2"(7bar)	-
2004 121280	1/2"x1/2"(8bar)	-
2004 121200	1/2"x1/2"(10bar)	-
2004 123410	1/2"x3/4"(1bar)	-
2004 123415	1/2"x3/4"(1.5bar)	-
2004 123420	1/2"x3/4"(2bar)	-
2004 123425	1/2"x3/4"(2.5bar)	-

Rregullator presioni ART.2865



Kodi	Permasat	Cmimi
286512	1/2	-
286534	3/4	-
		-
		-
		-
		-

Filter uji ART. 2390



Kodi	Permasat	Cmimi
2390 12	1/2"	-
2390 34	3/4"	-
2390 1	1"	-
2390 114	1"1/4	-
		-

Valvul sigurie 3bar 1/2 M x 1/2
ART.2004



Kodi	Permasat	Cmimi
2004 123430	1/2"x3/4"(3bar)	-
2004 123435	1/2"x3/4"(3.5bar)	-
2004 123440	1/2"x3/4"(4bar)	-
2004 123450	1/2"x3/4"(5bar)	-
2004 123460	1/2"x3/4"(6bar)	-
2004 123470	1/2"x3/4"(7bar)	-
2004 123480	1/2"x3/4"(8bar)	-
2004 123400	1/2"x3/4"(10bar)	-

Automatik mbushes



Kodi	Permasat	Cmimi
2110	1/2	-
		-
		-
		-
		-
		-

Cajrus linje ART. 2895



Kodi	Permasat	Cmimi
2895 12	1/2"	-
		-
		-
		-
		-

Cajrus linje ART. 2896

Kodi	Permasat	Cmimi
2896 38	3/8"	-
2896 34	3/4"	-

Rregullator mikser termostatik ART. 3953

Kodi	Permasat	Cmimi
3953 12	1/2"	-
3953 34	3/4"	-
3953 1	1"	-

Rregullator mikser termostatik ART. 3954

Kodi	Permasat	Cmimi
3954 34	3/4"	-
3954	1"	-

Rregullator mikser termostatik ART. 3955

Kodi	Permasat	Cmimi
3955 12	1/2"	-
3955 34	3/4"	-
3955 1	1"	-
3955 114	1"1/4	-
3955 112	1"1/2	-

Valvul sigurie

Kodi	Permasat	Cmimi
2006123430	1/2	-

Saracineske elektrike ART. 300729

Kodi	Permasat	Cmimi
300729 3408	3/4"(230V)	-
300729 108	1"(230V)	-
300729 11408	1"1/4(230V)	-
300829 3408	3/4"(24V)	-
300829 108	1"(24V)	-
300829 11408	1"1/4(24V)	-

Cajrues bronxi I nikeluar ART. 2042

Kodi	Permasat	Cmimi
2042 38	3/8"	-
2042 12	1/2"	-

Cajrues bronxi I nikeluar ART. 2068

Kodi	Permasat	Cmimi
2068 12	1/2"	-

Valvul termike&presioni

Kodi	Permasat	Cmimi
2006123430	1/2	-



GRUPET E PRESIONIT DHE PJESET E KEMBIMIT

Valvul sigurie per sistem diellore ART. 2006



Bar	Permasat	Cmimi
2006 123425	½"x3/4"(2.5bar)	-
2006 123430	½"x3/4"(3bar)	-
2006 123435	½"x3/4"(3.5bar)	-
2006 123440	½"x3/4"(4bar)	-
2006 123450	½"x3/4"(5bar)	-
2006 123460	½"x3/4"(6bar)	-
2006 123470	½"x3/4"(7bar)	-
2006 123480	½"x3/4"(8bar)	-
2006 123400	½"x3/4"(10bar)	-

Sensor per valvulen kunder kondesimit ART. 9400-9401



Kodi	Kv (m³/h)	Cmimi
9400 45	3.9 (45°C)	-
9400 55	3.9 (55°C)	-
9400 60	3.9 (60°C)	-
9400 70	3.9 (70°C)	-
9401 45	11,3-12,2(45°C)	-
9401 55	11,3-12,2 (55°C)	-
9401 60	11,3-12,2 (60°C)	-
9401 70	11,3-12,2 (70°C)	-

Saracineske elektrike 3 rrugeshe



Kodi	Permasa	Cmimi
300120140	1" + 3	-
3001203440	¾"	-

Valvul antikondense ART. 3966



Kodi	Permasa	Cmimi
3966 0145	3/4" (45°C)	-
3966 0155	3/4"(55°C)	-
3966 0160	3/4"(60°C)	-
3966 0170	3/4"(70°C)	-
3966 0245	1" (45°C)	-
3966 0255	1" (55°C)	-
3966 0260	1" (60°C)	-
3966 0270	1" (70°C)	-
3966 0345	1" (45°C)	-

Saracineske elektrike per fancoil



Kodi	Permasa	Cmimi
308834	¾"	-

Saracineske 3 rrugeshe ART.300520



Kodi	Permasa	Cmimi
300520 1240	1/2"	-
300520 3440	3/4"	-
300520 140	1"	-
300520 11440	1"1/4	-

Valvul antikondense ART. 3966



Kodi	Permasa	Cmimi
3966 0355	1" (55°C)	-
3966 0360	1" (60°C)	-
3966 0370	1" (70°C)	-
3966 0445	1"1/4(45°C)	-
3966 0455	1"1/4(50°C)	-
3966 0460	1"1/4(60°C)	-
3966 0470	1"1/4(70°C)	-

Valvul 2 rrugeshe ½" ART. 300115



Kodi	Permasa	Cmimi
300115 1240	1/2"	-
300115 3440	3/4"	-
300115 140	1"	-
300115 11440	1"1/4	-

Kit per system dysHEME ART.3480



Kodi	Permasa	Cmimi
3480 34	3/4"	-
3480 1	1"	-
3480 114	1"1/4	-



KOLEKTOR TË NDRYSHËM

*Kolektor per sistem ngrohje-ftohje
ART.3913*



Kodi	Permasa	Cmimi
3913 102	1''(2dalje)	-
3913 103	1''(3dalje)	-
3913 104	1''(4dalje)	-
3913 105	1''(5dalje)	-
3913 106	1''(6dalje)	-
3913 107	1''(7dalje)	-
3913 108	1''(9dalje)	-
3913 109	1''(9dalje)	-
3913 110	1''(10dalje)	-
3913 111	1''(11dalje)	-
3913 112	1''(12dalje)	-

*Kolektor per sistem ngrohje-ftohje
ART.3913*



Kodi	Permasa	Cmimi
3913 11402	1''1/4(2dalje)	-
3913 11403	1''1/4(3dalje)	-
3913 11404	1''1/4(4dalje)	-
3913 11405	1''1/4(5dalje)	-
3913 11406	1''1/4(6dalje)	-
3913 11407	1''1/4(7dalje)	-
3913 11408	1''1/4(8dalje)	-
3913 11409	1''1/4(9dalje)	-
3913 11410	1''1/4(10dalje)	-
3913 11411	1''1/4(11dalje)	-
3913 11412	1''1/4(12dalje)	-

*Kolektor per sistem ngrohje-ftohje
ART.3923*



Kodi	Permasa	Cmimi
3923 102	1''(2dalje)	-
3923 103	1''(3dalje)	-
3923 104	1''(4dalje)	-
3923 105	1''(5dalje)	-
3923 106	1''(6dalje)	-
3923 107	1''(7dalje)	-
3923 108	1''(9dalje)	-
3923 109	1''(9dalje)	-
3923 110	1''(10dalje)	-
3923 111	1''(11dalje)	-
3923 112	1''(12dalje)	-

*Kolektor per sistem ngrohje-ftohje
ART.3923*



Kodi	Permasa	Cmimi
3923 11402	1''1/4(2dalje)	-
3923 11403	1''1/4(3dalje)	-
3923 11404	1''1/4(4dalje)	-
3923 11405	1''1/4(5dalje)	-
3923 11406	1''1/4(6dalje)	-
3923 11407	1''1/4(7dalje)	-
3923 11408	1''1/4(8dalje)	-
3923 11409	1''1/4(9dalje)	-
3923 11410	1''1/4(10dalje)	-
3923 11411	1''1/4(11dalje)	-
3923 11412	1''1/4(12dalje)	-

*Kolektor per sistem ngrohje-ftohje
ART.3970*



Kodi	Permasa	Cmimi
3970 102	1''(2dalje)	-
3970 103	1''(3dalje)	-
3970 104	1''(4dalje)	-
3970 105	1''(5dalje)	-
3970 106	1''(6dalje)	-
3970 107	1''(7dalje)	-
3970 108	1''(9dalje)	-
3970 109	1''(9dalje)	-
3970 110	1''(10dalje)	-
3970 111	1''(11dalje)	-
3970 112	1''(12dalje)	-

*Kolektor per sistem ngrohje-ftohje
ART.3970*



Kodi	Permasa	Cmimi
3970 11402	1''1/4(2dalje)	-
3970 11403	1''1/4(3dalje)	-
3970 11404	1''1/4(4dalje)	-
3970 11405	1''1/4(5dalje)	-
3970 11406	1''1/4(6dalje)	-
3970 11407	1''1/4(7dalje)	-
3970 11408	1''1/4(8dalje)	-
3970 11409	1''1/4(9dalje)	-
3970 11410	1''1/4(10dalje)	-
3970 11411	1''1/4(11dalje)	-
3970 11412	1''1/4(12dalje)	-



GRUPET E PRESIONIT DHE PJESET E KEMBIMIT

Pompe qarkullimi Wilo per sistem dysHEMEJE ART.2185



Kodi	Box	Cmimi
2185 130EA	1	-

Saracineske hollandeze kendore ART.3062



Kodi	Permasa	Cmimi
3062 134B	¾"Fx1"M	-
3062 134R	¾"Fx1"M	-
3062 1B	1"Fx1"M	-
3062 1R	1"Fx1"M	-

Saracineske hollandeze ART.3057 - 3058



Kodi	Permasa	Cmimi
3057 1B	1"Fx1"M	-
3057 1R	1"Fx1"M	-
3058 1B	1"Fx1"M	-
3058 1R	1"Fx1"M	-

PRESSFAR Saracineske hollandeze kendore ART. 5951



Kodi	Permasa	Cmimi
59512601	1"(26x3tubi)	-
59512602	1"(26x3tubi)	-
59513201	1"(32x3tubi)	-
59513202	1"(32x3tubi)	-

Koke saracineske elektrike per fancoil ART.1909



Kodi	Tensioni	Cmimi
1909	24V	-
1919	230 V	-
1929	24V	-
1939	230 V	-

Termostat ambianti elektronik Ngrhje-Ftohje ART.7944



Kodi	Box	Cmimi
7944	1	-

Termostat ambianti elektromekanik ON/OFF ART.7948



Kodi	Box	Cmimi
7948	1	-

Ti termike ART.3430



Kodi	Permasa	Cmimi
3430 34	3/4"	-
3430 1	1"	-
3430 114	1"1/4	-

Ti fundore kolektori F ART.4060



Kodi	Madhesia	Cmimi
40603438	¾"(3/8x1/2")	-
40603412	¾"(1/2"x1/2")	-
4060138	1"(3/8"x1/2")	-
4060112	1"(1/2"x1/2")	-
406011438	1"1/4(3/8"x1/2")	-
406011412	1"1/4(1/2"x1/2")	-
406011238	1"1/2(3/8"x1/2")	-
406011212	1"1/2(1/2"x1/2")	-

Brryl bronxi reduktori I nikeluar
ART.4050

Kodi	Permasa	Cmimi
4050 3414	3/8"x1/2"	-
4050 3438	3/4"x1/2"	-
4050 3412	3/4"x1/2"	-
4050 114	1"x1/4"	-
4050 138	1"x3/8"	-
4050 112	1"x1/2"	-
4050 11438	1"1/4x3/8"	-
4050 11412	1"1/4x1/2"	-

Tapa bronxi e nikeluar **ART.4150**

Kodi	Permasa	Cmimi
4150 34	3/4"	-
4150 1	1"	-
4150 114	1"1/4	-
4150 112	1"1/2	-
4150 2	2"	-

Tapa bronxi nikeluar **ART.4100**

Kodi	Permasa	Cmimi
4100 12	1/2"	-
4100 34	3/4"	-
4100 1	1"	-
4100 114	1"x1/4"	-
4100 112	1"1/2	-
4100 2	2"	-

Rubinet shkarkimi kaldaje
ART.3439

Kodi	Box	Cmimi
3439 12	1/2"	-

Adaptor Saracinesk radiator me dalje poshte **ART.6081**

Kodi	Permasa	Cmimi
6081	1/2	-

Buketon kolektori bakri
ART.8429

Kodi	Lloji	Cmimi
8429 15	Ø 15	-
8429 16	Ø 16	-

Ti fundore kolektori M **ART.4061**

Kodi	Madhesia	Cmimi
40613438	3/4" (3/8x1/2")	-
40613412	3/4" (1/2"x1/2")	-
4061138	1" (3/8"x1/2")	-
4061112	1" (1/2"x1/2")	-
406111438	1"1/4 (3/8"x1/2")	-
406111412	1"1/4 (1/2"x1/2")	-
406111238	1"1/2 (3/8"x1/2")	-
406111212	1"1/2 (1/2"x1/2")	-

Buketon kolektori p-ex
ART.6052

Kodi	Ø diametri	Cmimi
6052 95147	10.5x1.25	-
6052 48186	12x2.15	-
6052 4847	12x2	-
6052 48184	12.1.35	-
6052 9761005	12.7x1.7	-
6052 976186	12.7x2.4	-
6052 6563	14x1.5	-
6052 6545	14x2	-
6052 4645	15x2.5	-
6052 4663	15x2	-
6052 46173	15x1.7	-

Buketon kolektori p-ex
ART.6052

Kodi	Ø diametri	Cmimi
6052 4661	15x1.5	-
6052 5863	16x2.5	-
6052 58172	16x2.2	-
6052 5861	16x2	-
6052 58262	16x1.8	-
6052 5864	16x1.5	-
6052 58180	16x2.7	-
6052 15061	16.8x2.4	-
6052 150829	17x2.25	-
6052 15043	17x2	-
6052 6043	17.8x2.4	-



DADO PER RAKORDE ME KOMPRESIM

Buketon kolektori p-ex
ART.6052



Kodi	Ø diameteri	Cmimi
6052 60180	17.8x3.6	-
6052 4443	18x2.5	-
6052 44221	18x2.2	-
6052 4468	18x2	-
6052 8043	20x3.5	-
6052 8068	20x3	-
6052 80185	20x2.8	-
6052 80222	20x2.3	-
6052 8269	20x2.15	-
6052 80214	20x2	-
6052 80261	20x1.9	-

Buketon kolektori pex-al-
pex ART.6055



Kodi	Ø diameteri	Cmimi
6055 902901	11.6x1.5	-
6055 48901	12x1.8	-
6055 65193	14x2	-
6055 46193	15x2.5	-
6055 58190	16x2	-
6055 58200	16x2.25	-
6055 58278	16.2x2.6	-
6055 150200	16.8x2.5	-
6055 150810	17x2	-
6055 44191	18x2	-

Buketon kolektori pex-al-
pex ART.6055



Kodi	Ø diameteri	Cmimi
6055 80204	20x2	-
6055 80192	20x2.25	-
6055 80201	20x2.5	-
6055 80191	20x2.9	-

Ecentrik ART.5560



Kodi	Permasa	Cmimi
5560112	½"	-
5560212	½"	-
5560312	½"	-
5560412	½"	-

Kolektor I nikeluar ART.3850



Kodi	Permasa	Cmimi
3850 34	¾"	-
3850 1	1"	-

Kolektor I nikeluar ART.3856



Kodi	Permasa	Cmimi
3856 34	¾"	-
3856 1	1"	-

Koke saracineske per fan coil



Kodi	Tensioni	Cmimi
1909	24V	-
1919	230V	-
1929	24V	-
1939	230V	-

Koke Termostatike



Kodi	Box	Cmimi
1824	1	-

Saracineske kaloriferi tek kendor ART.1055

Kodi	Permasa	Cmimi
1055 38	3/8"	-
1055 12	1/2"	-

Saracineske kaloriferi tek kendor ART.1105

Kodi	Permasa	Cmimi
1105 38	3/8"	-
1105 12	1/2"	-

Saracineske kaloriferi tek e drejte ART.1255

Kodi	Permasa	Cmimi
1255 38	3/8"	-
1255 12	1/2"	-

Dedektor kaloriferi i drejte ART.1305

Kodi	Permasa	Cmimi
1305 38	3/8"	-
1305 12	1/2"	-

Saracineske kaloriferi tek kendor ART.1155

Kodi	Permasa	Cmimi
1155 38	3/8"	-
1155 12	1/2"	-

Dedektor kendore ART.1215

Kodi	Permasa	Cmimi
1215 38	3/8"	-
1215 12	1/2"	-
1215 34	3/4"	-

Saracineske kaloriferi tek e drejte ART.1355

Kodi	Permasa	Cmimi
1355 38	3/8"	-
1355 12	1/2"	-

Saracineske kaloriferi tek kendore termostatike ART.1621

Kodi	Permasa	Cmimi
1621 12	1/2"	-

Saracineske kaloriferi tek kendore termostatike

Kodi	Permasa	Cmimi
1611 12	24x19	-

Dedektor kendore I kromuar

Kodi	Permasa	Cmimi
012812P	1/2"	-

Dedektor kendore I bardhe

Kodi	Permasa	Cmimi
012912P	1/2"	-

Saracineske kaloriferi banje e drejte termostatike ART.1435

Kodi	Permasa	Cmimi
1435	1/2"(Ø 10)	-

Saracineske kaloriferi banje kendore termostatike ART.1436

Kodi	Permasa	Cmimi
1436	1/2"(Ø 10)	-

Saracineske kaloriferi dopjo me dalje poshte kendore

Kodi	Permasa	Cmimi
1422	24x19	-

Saracineske kaloriferi dopjo me dalje poshte e drejte

Kodi	Permasa	Cmimi
1424	24x19	-

Cajrues bronxi / nikeluar / bardhe ART.0306



Kodi	Permasa	Cmimi
0306 12	½"	-

Saracineske kaloriferi alumini doppio ART.1456



Kodi	Permasa	Cmimi
14561212	24x19	-

Saracineske kaloriferi doppio e shkurter ART.1452



Kodi	Permasa	Cmimi
145212	24x19	-

Saracineske kaloriferi doppio e shkurter ART.1473



Kodi	Permasa	Cmimi
147312	24x19	-

Saracineske kaloriferi alumini doppio ART.1451



Kodi	Permasa	Cmimi
14511212	24x19	-

Saracineske kaloriferi doppio ART.1442



Kodi	Permasa	Cmimi
144212	24x19	-

Bashkues me prese ART.5902



Kodi	Permasa	Cmimi
59021601	16x2	-

TI me prese ART.5908



Kodi	Permasa	Cmimi
59081601	16x2-16x2-16x2	-

TI me prese F ART.5912



Kodi	Permasa	Cmimi
59121601	16x2x1/2	-

Brryl me prese F ART.5905



Kodi	Permasa	Cmimi
59051601	16x2x1/2	-
59051801	18x2x1/2	-

Brryl me prese M ART.5904



Kodi	Permasa	Cmimi
59041601	16x2x1/2	-
59042002	3/4x2x20	-

Brryl doppio me prese



Kodi	Permasa	Cmimi
59061601	16x16x2	-

Brryl kolektori me rakord me prese ART.5922



Kodi	Permasa	Cmimi
59222001	1/2x20x2	-

Stafa per rakorde me mbrojtje murore ART.7477



Kodi	Box	Cmimi
7477	1	-

Buketon kolektori me prese ART.5915



Kodi	Box	Cmimi
59151601	24*19*16	-
59152001	24*19*20	-

RAKORDERI ME PRESË PËR MULTISTRAT

Rakord kolektori me prese



Kodi	Permasa	Cmimi
59193201	1" x 32 x 3	-
59191801	1/2" x 18 x 2	-
59192001	1/2" x 20 x 2	-
59192004	3/4" x 20 x 2	-
59192602	3/4" x 26 x 3	-
59191601	1/2" x 16 x 2	-

Ti me prese me mbajtëse murore
ART.5925



Kodi	Permasa	Cmimi
5925 1601	1/2" x 16 x 2	-
5925 1801	1/2" x 18 x 2	-
5925 2001	1/2" x 20 x 2	-
5925 2003	1/2" x 20 x 2.5	-

Rubinet incaso / kromuar



Kodi	Permasa	Cmimi
5960 12	1/2"	-
5960 34	3/4"	-

Rakord me prese M ART.5900



Kodi	Permasa	Cmimi
59001401	1/2" x 14 x 2	-
59001601	1/2" x 16 x 2	-
59001602	1/2" x 16 x 2.25	-
59001801	1/2" x 18 x 2	-
59001802	3/4" x 18 x 2	-
59002001	1/2" x 20 x 2	-
59002002	3/4" x 20 x 2	-
59002003	1/2" x 20 x 2.25	-
59002004	3/4" x 20 x 2.25	-

Rakord me prese M ART.5900



Kodi	Permasa	Cmimi
59002005	1/2" x 20 x 2.5	-
59002006	3/4" x 20 x 2.5	-
59002501	3/4" x 25 x 2.5	-
59002502	1" x 25 x 2.5	-
59002601	3/4" x 26 x 3	-
59002602	1" x 26 x 3	-
59003201	1" x 32 x 3	-
59003202	1" 1/4 x 32 x 3	-
59003203	3/4" x 32 x 3	-

Rakord me prese M ART.5900



Kodi	Permasa	Cmimi
59004001	1" x 40 x 3.5	-
59004002	1" 1/4 x 40 x 3.5	-
59004003	1" x 40 x 4	-
59004004	1" 1/4 x 40 x 4	-
59005001	1" 1/4 x 50 x 4	-
59005002	1" 1/4 x 50 x 4.5	-
59005003	1" 1/2 x 50 x 4	-
59005004	1" 1/2 x 50 x 4.5	-
59006301	2" x 63 x 4.5	-

Rakord me prese F ART.5901



Kodi	Permasa	Cmimi
59011401	1/2" x 14 x 2	-
59011601	1/2" x 16 x 2	-
59011602	1/2" x 16 x 2.25	-
59011801	1/2" x 18 x 2	-
59011802	3/4" x 18 x 2	-
59012001	1/2" x 20 x 2	-
59012002	3/4" x 20 x 2	-
59012003	1/2" x 20 x 2.25	-
59012004	3/4" x 20 x 2.25	-

Rakord me prese F ART.5901



Kodi	Permasa	Cmimi
59012005	1/2" x 20 x 2.5	-
59012006	3/4" x 20 x 2.5	-
59012501	3/4" x 25 x 2.5	-
59012502	1" x 25 x 2.5	-
59012601	3/4" x 26.3	-
59012602	1" x 26 x 3	-
59013201	1" x 32 x 3	-
59013202	1" 1/4 x 32 x 3	-
59014001	1" x 40 x 3.5	-

Rakord me prese F ART.5901



Kodi	Permasa	Cmimi
59014002	1" 1/4 x 40 x 3.5	-
59014003	1" x 40 x 4	-
59014004	1" 1/4 x 40 x 4	-
59015001	1" 1/4 x 50 x 4	-
59015002	1" 1/4 x 50 x 4.5	-
59015003	1" 1/2 x 50 x 4	-
59015004	1" 1/2 x 50 x 4.5	-
59016301	2" x 63 x 4.5	-

Rubinet incaso I kromuar me prese
ART.5961

Kodi	Permasa	Cmimi
59611601	½"x16x2	-
59611602	½"x16x2.25	-
59611801	½"x18x2	-
59612001	½"x20x2	-
59612002	½"x20x2.25	-
59612003	½"x20x2.5	-
59612601	¾"x26x3	-
59613201	¾"x32x3	-

Mates I bere nga PA
ART.9005

Kodi	Ø Tubi	Cmimi
9005 1426	14-16-18-20-25-26	-
9005 3263	32-40-50-63	-
9005 1463	14-16-18-20-25-26-32-40-50-63	-

Kolektor ART.3600-3650-3700

Kodi	Permasat	Cmimi
3600 34	¾"(2dalje)	-
3600 1	1"(2dalje)	-
3600 114	1"1/4(2dalje)	-
3650 34	¾"(3dalje)	-
3650 1	1"(3dalje)	-
3650 114	1"1/4(3dalje)	-
3700 34	¾"(4dalje)	-
3700 1	1"(4dalje)	-
3700 114	1"1/4(4dalje)	-

Buketon kolektori bakri ART.5429

kodi	Permasa	Cmimi
542916	24*19*16*2.0	-

Zgjatues inoksi 30mm ART.8880

Kodi	Permasa	Cmimi
8880 30	24x19	-

Celes kaloriferi dopjo 24x19
ART.6004

Kodi	Permasa	Cmimi
6004	ES 27-30	-

Celes ajernxjeres radiator ART.6300

kodi	Permasa	Cmimi
6300	5	-

Rozet plastike per saracineske dopjo

kodi	Box	Cmimi
615016	1	-

Rozet plastike per saracineske teke

kodi	Box	Cmimi
620016	1	-

Set me celesa

kodi	Box	Cmimi
7405	1	-

Fole

kodi	Permasa	Cmimi
561012+9001	24*19*16	-



DIVA+

 **CherBros**
more than fittings



www.cherbros.gr www.cherbros.gr www.cherbros.gr

Valvul sferike F-F Dorezë çeliku
7001



Kodi	Përmasat	Sasia	Cmimi
70011000040	1/2"	1/40	-
70011000060	3/4"	1/30	-
70011000080	1"	1/20	-
70011000100	1 1/4"	1/15	-
70011000120	1 1/2"	1/8	-
70011000160	2"	1/5	-

Valvul sferike F-F / Dorezë alumini
7001



Kodi	Përmasat	Sasia	Cmimi
70012000040	1/2"	1/40	-
70012000060	3/4"	1/30	-
70012000080	1"	1/15	-
70012000100	1 1/4"	1/10	-

Valvul sferike F-F / Dorezë flutur
7001



Kodi	Përmasat	Sasia	Cmimi
70013000040	1/2"	1/50	-
70013000060	3/4"	1/40	-
70013000080	1"	1/25	-
70013000100	1 1/4"	1/15	-

Valvul sferike M-F / Dorezë flutur
7002



Kodi	Përmasat	Sasia	Cmimi
70023000040	1/2"	1/50	-
70023000060	3/4"	1/40	-
70023000080	1"	1/25	-
70023000100	1 1/4"	1/15	-

Valvul sferike M-F / Dorezë alumini
7002



Kodi	Përmasat	Sasia	Cmimi
70022000040	1/2"	1/40	-
70022000060	3/4"	1/30	-
70022000080	1"	1/15	-
70022000100	1 1/4"	1/10	-

Valvul sferike DIVA M-F/Dorezë çeliku , 7002



Kodi	Përmasat	Sasia	Cmimi
70021000040	1/2"	1/40	-
70021000060	3/4"	1/30	-
70021000080	1"	1/20	-
70021000100	1 1/4"	1/10	-

Valvul sferike bashkuese /me dorezë flutur ,7003



Kodi	Përmasat	Sasia	Cmimi
70023000040	1/2"	1/40	-
70023000060	3/4"	1/30	-
70023000080	1"	1/15	-
70023000100	1 1/4"	1/10	-

Valvul sferike me Termometer 1"
1741



Kodi	Ngjyra	Sasia	Cmimi
17410100008	Dorezë blu	1/15	-
17410200008	Dorezë e kuqe	1/15	-

Zgjatja e dorezës
7007



Kodi	Përmasat	Sasia	Cmimi
70073000040	1/2"-3/4"	1/100	-

Valvula sferike F-F/Dorezë çeliku
7001



Kodi	Përmasat	Sasia	Cmimi
270011000200	2 1/2"	6	-
270011000240	3"	5	-
270011000320	4"	2	-

Panele Diellore

Ngrohje & Ftohje

Hidraulike

Hidrosanitare

Aksesore të ndryshëm

 Valvul për gaz F-F / dorezë çeliku
 5727

Kodi	Përmasat	Sasia	Cmimi
57270000004	1/2"	1/40	-
57270000006	3/4"	1/30	-
57270000008	1"	1/20	-

 Valvul për gaz F-F / dorezë çeliku
 5727

Kodi	Përmasat	Sasia	Cmimi
57270000004	1/2"	1/40	-
57270000006	3/4"	1/30	-
57270000008	1"	1/20	-

 Rubinet / dorezë alumini
 1630

Kodi	Përmasat	Sasia	Cmimi
16301200040	1/2"	1/20	-

 Rubinet 2mënyrësh
 Antifriz+Dollap/Dorezë alumini , 1630

Kodi	Përmasat	Sasia	Cmimi
16301200140	1/2"	1/15	-

Rubinet / dorezë alumini 1630



Kodi	Përmasat	Sasia	Cmimi
16300000104	1/2"	1/30	-

Rubinet / dorezë flutur 1630



Kodi	Përmasat	Sasia	Cmimi
16300000004	1/2"	1/30	-

 Rubinet / dorezë flutur
 1633

Kodi	Përmasat	Sasia	Cmimi
1603010004	1/2"	1/30	-
1603010006	3/4"	1/320	-
1603010008	1"	1/15	-

Valvul sferike këndore / me rozetë INOX ,0210



Kodi	Përmasat	Sasia	Cmimi
0210040409	1/2" x 1/2" kromuar	1/40	-
0210040609	1/2" x 3/4" kromuar	1/30	-
0210040309	1/2" x 3/8" kromuar(ø10)	1/15	-
0210040305	1/2" x 3/8" kromuar(ø10)	1/10	-

Valvul sferike këndore / me rozetë INOX , 0210



Kodi	Përmasat	Sasia	Cmimi
0210040408	1/2" x 1/2" kromuar	1/40	-
0210040608	1/2" x 3/4" kromuar	1/40	-
0210040308	1/2" x 3/8" kromuar(ø10)	1/40	-
0210040306	1/2" x 3/8" kromuar(ø10)	1/40	-

Valvul sferike këndore me rozetë INOX , 0210



Kodi	Përmasat	Sasia	Cmimi
0210060400	1/2" x 3/4" kromuar	1/40	-

Valvul sferike këndore, 0260



Kodi	Përmasat	Sasia	Cmimi
0260040401	1/2" x 1/2" kromuar	1/40	-
0260040601	1/2" x 3/4" kromuar	1/40	-
0260030401	1/2" x 3/8" kromuar (Φ10)	1/40	-

Valvul sferike këndore, ABS 0260



Kodi	Përmasat	Sasia	Cmimi
0260040400	1/2" x 1/2" kromuar	1/40	-
0260040600	1/2" x 3/4" kromuar	1/40	-
0260030400	1/2" x 3/8" kromuar (Φ10)	1/40	-

Dado me unazë për valvulat këndore , 1100



Kodi	Përmasat	Sasia	Cmimi
110000301	3/8"	20	-

Rozeta INOX 2340

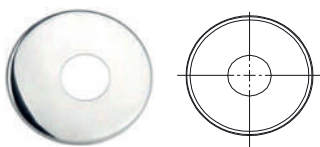

Kodi	Përmasat	Sasia	Cmimi
2340040002	1/2"	100	-

Adaptor Allen 0215



Kodi	Përmasat	Sasia	Cmimi
0215060409	3/4" - 1/2"	10/400	-

MINI Valvul Sferike 1/2" - 24 x 19
 M-M e kromuar , 0220

Kodi	Ngjyra	Sasia	Cmimi
02202419MX	Doreze Blu	1/100	-
02202419KX	Doreze e Kuqe	1/100	-

 MINI Valvul Sferike 1/2" X 1/2"
 M-F e kromuar , 0220

Kodi	Ngjyra	Sasia	Cmimi
0220210409	Doreze Blu	1/100	-
0220210419	Doreze e Kuqe	1/100	-

 Valvula e topit MINI 1/2" X 1/2"
 M-F , 0220

Kodi	Ngjyra	Sasia	Cmimi
0220210400	Doreze Blu	1/100	-
0220210410	Doreze e Kuqe	1/100	-

 MINI Valvul Sferike 1/2 AL PEX e
 kromuar , 0251

Kodi	Përmasat	Sasia	Cmimi
02511620MX	16x2.0 Blu	1/75	-
02511620KX	16x2. Kuqe	1/75	-
02511820MX	18x2.0 Blu	1/75	-
02511820KX	18x2.0 e Kuqe	1/75	-

 MINI Valvul Sferike 1/2 PE-X e kromuar
 0250

Kodi	Përmasat	Sasia	Cmimi
02501525MX	15x2.5 Blu	1/75	-
02501525KX	15x2.5 e Kuqe	1/75	-
02501620MX	16x2.0 Blu	1/75	-
02501620KX	16x2.0 e Kuqe	1/75	-
02501820MX	18x2.5 Blu	1/75	-
02501820KX	18x2.0 e Kuqe	1/75	-
02501825MX	18x2.0 Blu	1/75	-
02501825KX	18x2.5 e Kuqe	1/75	-

 MINI Valvul Sferike 1/2 PE-X e kromuar
 0250

Kodi	Përmasat	Sasia	Cmimi
02501525MK	15x2.5 Blu	1/75	-
02501525KK	15x2.5 e Kuqe	1/75	-
02501620MK	16x2.0 Blu	1/75	-
02501620KK	16x2.0 e Kuqe	1/75	-
02501820MK	18x2.5 Blu	1/75	-
02501820KK	18x2.0 e Kuqe	1/75	-
02501825MK	18x2.0 Blu	1/75	-
02501825KK	18x2.5 e Kuqe	1/75	-

 Valvul sferike
 4007

Kodi	Përmasat	Sasia	Cmimi
4007040000	1/2"	1/100	-
4007040900	1/2"l kromuar	1/100	-

 Valvul sferike MAGNETO
 4007

Kodi	Përmasat	Sasia	Cmimi
4007040910	1/2"	1/100	-

VALVULAT REDUKTUESE DHE KONTROLLUESE TE PRESIONIT DHE VALVULA AUTOMATIKE ME MBUSHJE

Kondravalvul me suste
0410



Kodi	Përmasat	Sasia	Cmimi
0410100004	1/2"	1/40	-
0410100006	3/4"	1/24	-
0410100008	1"	1/15	-
0410100010	1 1/4"	1/8	-
0410100012	1 1/2"	1/4	-
0410100016	2"	1/2	-

Site per valvul
0410



Kodi	Përmasat	Sasia	Cmimi
0410200004	1/2"	250	-
0410200006	3/4"	120	-
0410100008	1"	80	-
0410200010	1 1/4"	50	-
0410100012	1 1/2"	30	-
0410100016	2"	20	-

Valvul automatike mbushese
3417AdK



Kodi	Përmasat	Sasia	Cmimi
34170409100	1/2"	1/15	-

Valvul e radiatorit monotub M
 3700

Kodi	Përmasat	Sasia	Cmimi
37000001504	1/2"-M 24 X 19	1/15	-

 Tub i kromuar
 3005

Kodi	Përmasat	Sasia	Cmimi
30050000001	Φ15 x 65 cm Bronz	10	-
30050000002	Φ15 x 90 cm Bronz	10	-
30050000006	Φ15 x 90 cm Hekur	10	-

 Tub i kromuar mashkull
 3005

Kodi	Përmasat	Sasia	Cmimi
30050150000	Φ15 X 1/2"	10/100	-

 Valvul radiatori
 3723

Kodi	Përmasat	Sasia	Cmimi
37230000004	1/2" X 1/2"	1/50	-

 Valvul radiatori
 3713

Kodi	Përmasat	Sasia	Cmimi
37130000004	1/2" X 1/2"	1/50	-

 Valvul këndore radiatori
 3740

Kodi	Përmasat	Sasia	Cmimi
37400000000	1/2"-M 24 X 19	1/50	-

 Valvul radiatori
 3740

Kodi	Përmasat	Sasia	Cmimi
37130000000	1/2"-M 24 X 19	1/50	-

 Kokë termostatike
 3009

Kodi	Përmasat	Sasia	Cmimi
30090500001	-	1/75	-

 Valvul termostatike
 3019

Kodi	Përmasat	Sasia	Cmimi
30192000001	-	1/50	-

 Valvul termostatike
 3019

Kodi	Përmasat	Sasia	Cmimi
30190000001	-	1/50	-

Shufer bronzi per kolektore ,
3/4" x 1/2" , 0440



Shufra bronzi per kolektore ,
1" x 1/2" , 0440



1 1/4" x 1/2" " shufra bronzi per
Kolektore , 0440



Kodi	Lloji	Sasia	Cmimi
0440010600	1way	1/80	-
0440020600	2 ways	1/50	-
0440030600	3 ways	1/30	-
0440040600	4 ways	1/20	-
0440050600	5 ways	1/15	-
0440060600	6 ways	1/10	-
0440070600	7 ways	1/10	-
0440080600	8 ways	1/10	-
0440090600	9 ways	1/10	-
0440100600	10 ways	1/10	-

Kodi	Lloji	Sasia	Cmimi
0440010800	1way	1/75	-
0440020800	2 ways	1/40	-
0440030800	3 ways	1/25	-
0440040800	4 ways	1/15	-
0440050800	5 ways	1/15	-
0440060800	6 ways	1/10	-
0440070800	7 ways	1/10	-
0440080800	8 ways	1/10	-
0440090800	9 ways	1/10	-
0440100800	10 ways	1/10	-

Kodi	Lloji	Sasia	Cmimi
0440011000	1way	1/60	-
0440021000	2 ways	1/30	-
0440031000	3 ways	1/20	-
0440041000	4 ways	1/10	-
0440051000	5 ways	1/10	-
0440061000	6 ways	1/10	-
0440071000	7 ways	1/10	-
0440081000	8 ways	1/10	-
0440091000	9 ways	1/10	-
0440101000	10 ways	1/10	-

Fasheta kolektori, 0490



Nipel reduktuese 24 X 19 unazë-O
1220



Nipel reduktuese 1/2"x3/4 eurocono
unazë-O , 1220



Kodi	Përmasat	Sasia	Cmimi
0490060810	3/4"-1"-1 1/4"	25	-

Kodi	Përmasat	Sasia	Cmimi
1220040070	1/2" - 24X19	10/200	-
1220040077	1/2" - 24X19 kromuar	10/200	-

Kodi	Përmasat	Sasia	Cmimi
1220040070	1/2" - 24X19	10/200	-
1220040077	1/2" - 24X19 kromuar	10/200	-

Bashkues bronxi
1220



Kodi	Përmasat	Sasia	Cmimi
0470060000	3/4"	10/300	-
0470080000	1"	10/150	-
0470100000	1 1/4"	10/120	-

Kolektor "EVO", 3860



Kolektor "EVO", 3850



Kolektor "EVO", 3850



Kodi	Përmasat	Sasia	Cmimi
3860000802	1" X 2 Valvul	1/24	-
3860000803	1" X 3 Valvul	1/24	-
3860000804	1" X 4 Valvul	1/16	-
3860000805	1" X 5 Valvul	1/16	-

Kodi	Përmasat	Sasia	Cmimi
3850000802	1" X 2 Valvul	1/27	-
3850000803	1" X 3 Valvul	1/27	-
3850000804	1" X 4 Valvul	1/18	-
3850000805	1" X 5 Valvul	1/18	-

Kodi	Përmasat	Sasia	Cmimi
3850000602	3/4" X 2 Valvul	1/30	-
3850000603	3/4" X 3 Valvul	1/30	-
3850000604	3/4" X 4 Valvul	1/21	-
3850000605	3/4" X 5 Valvul	1/21	-

Tapa bronxi 1322



Kodi	Përmasat	Sasia	Cmimi
1322060700	3/4"	1/250	-
1322060701	3/4" -i kromuar	1/250	-
1322080700	1"	1/150	-
1322080709	1" i kromuar	1/150	-
1322100700	1 1/4"	1/100	-
1322100709	1 1/4" -i kromuar	1/100	-

Ti mashkull 0460



Kodi	Përmasat	Sasia	Cmimi
0460040804	1/2" x 1" x 1/2"	5/70	-
0460040807	1/2" X 1" X 1/2"	5/70	-
0460040879	1/2" X 1" X 1/2" i kromuar	5/70	-

Tape femer 1322



Kodi	Përmasat	Sasia	Cmimi
1310024191	24x19	10/150	-
1312080709	1"	10/150	-

 Instrument per kolektore EVO
 3000

Kodi	Përmasat	Sasia	Cmimi
30000000002	27/30	40	-

DADO PER RAKORDE ME KOMPRESIM

Buketon Kolektori i kromuar M 24X19 për tuba bakri , 3005



Kodi	Përmasat	Sasia	Cmimi
30005001501	15 x 1	1/100	-
30005001601	16 x 1	1/100	-
30005001801	18 x 1	1/100	-

Buketon Kolektori i kromuar M 24X19 për tuba PE-X , 3002



Kodi	Përmasat	Sasia	Cmimi
30021504250	15 x 2.5	1/70	-
30021604200	16 x 2.0	1/70	-
30021804200	18 x 2.0	1/70	-
30021804250	18 x 2.5	1/70	-

Buketon Kolektori i kromuar M 24x19 për tubat AL-PEX , 3006



Kodi	Përmasat	Sasia	Cmimi
30006001602	16.0 x 2.0	1/70	-
30006001622	16.2 x 2.6	1/70	-
30006001820	18.0 x 2.0	1/70	-
30006002020	20.0 x 2.0	1/60	-

Buketon Kolektori i kromuar 3/4" për tuba bakri , 3005



Kodi	Përmasat	Sasia	Cmimi
30005061501	15 x 1	1/80	-
30005061601	16 x 1	1/80	-
30005061801	18 x 1	1/80	-

Buketon Kolektori i kromuar 3/4" për tubat PE-X , 3002



Kodi	Përmasat	Sasia	Cmimi
30021506250	15 x 2.5	1/70	-
30021606200	16 x 2.0	1/70	-
30021706200	17x 2.0	1/70	-

Buketon Kolektori i kromuar 3/4" për tubat PE-X , 3002



Kodi	Përmasat	Sasia	Cmimi
30021806200	18 x 2.0	1/70	-
30021806250	18 x 2.5	1/60	-
30022006200	20.0 x 2.0	1/60	-

Buketon Kolektori i kromuar 3/4" për tubat AL-PEX , 3006



Kodi	Përmasat	Sasia	Cmimi
300601602	16.0 x 2.0	1/60	-
3006061820	18 x 2.0	1/60	-
3006062020	20x 2.0	1/50	-

Brryl komprimimi për tub PE-X me kuti shpërndarëse plastike ,0860



Kodi	Përmasat	Sasia	Cmimi
0861150425	15 x 2,5	1/50	-
0861160421	16 x 2,0	1/50	-
0861180420	18 x 2,0	1/50	-
0861180425	18 x 2,5	1/50	-

Brryl komprimimi për tub AL- PEX me kuti shpërndarëse plastike ,0860



Kodi	Përmasat	Sasia	Cmimi
0860160422	16 x 2,0	1/50	-
0861180422	18 x 2,0	1/50	-

Brryl komprimimi për tubat PE-X 0860



Kodi	Përmasat	Sasia	Cmimi
0860150425	15 x 2,5	1	-
0860160421	16 x 2,0	1	-
0860180420	18 x 2,0	1	-
0860180425	18 x 2,5	1	-

Brryl me Fije 24X19 me kuti plastike shpërndarëse, 0860



Kodi	Përmasat	Sasia	Cmimi
0861241901	24 x 19	1/50	-

Brryl me rakord me prese pr tub AL-PEX me kuti plastike shpërndarëse ,0860



Kodi	Përmasat	Sasia	Cmimi
0861160432	24 x 19	1/50	-

Brryl komprimimi për tubat AL-PE-X 0860



Kodi	Përmasat	Sasia	Cmimi
0860160422	16 x 2.0	1	-
0861180422	18 x 2.0	1	-

Brryl me Fije 24X19 0860



Kodi	Përmasat	Sasia	Cmimi
0860160432	16.0 x 2.0	1	-

Brryl për t'iu përshtatur tubave AL-PEX , 0860



Kodi	Përmasat	Sasia	Cmimi
0860160432	16.0 x 2.0	1	-

Kuti shpërndarëse plastike(Përfshin bazën plastike dhe grupin e vidave dhe rubinetave) , 0860



Kodi	Përmasat	Sasia	Cmimi
08600000	-	1	-

Kllapa metalike 0861



Kodi	Përmasat	Sasia	Cmimi
0861505038	-	1	-

Rakord mashkull per PE-X
0610

Rakord femer per PE-X
0620

Rakord i dyfishte per PE-X
0630

Kodi	Përmasat	Sasia	Cmimi
0610150425	15 X 2.5 X 1/2"	10/120	-
0610160421	16 X 2.0 X 1/2"	10/120	-
0610160422	16 X 2.2 X 1/2"	10/120	-
0610180420	18 X 2.0 X 1/2"	10/100	-
0610180425	18 X 2.5 X 1/2"	10/100	-
0610180620	18 X 2.0 X 3/4"	10/100	-
0610180625	20 X 2.0 X 1/2"	10/100	-
0610200420	22 X 3.0 X 1/2"	10/100	-
0610220430	22 X 3.0 X 3/4"	10/80	-
0610280830	28 X 3.0 X 1"	50	-
0610320830	32 X 3.0 X 1"	40	-

Kodi	Përmasat	Sasia	Cmimi
0620150425	15 X 2.5 X 1/2"	10/120	-
0620160421	16 X 2.0 X 1/2"	10/120	-
0620160422	16 X 2.2 X 1/2"	10/120	-
0620180420	18 X 2.0 X 1/2"	10/100	-
0620180425	18 X 2.5 X 1/2"	10/100	-
0620180620	18 X 2.0 X 3/4"	10/100	-
0620180625	20 X 2.0 X 1/2"	10/100	-
0620200420	22 X 3.0 X 1/2"	10/100	-
0620220430	22 X 3.0 X 3/4"	10/80	-
0620280830	28 X 3.0 X 1"	50	-
0620320830	32 X 3.0 X 1"	40	-

Kodi	Përmasat	Sasia	Cmimi
0630151525	15 X 15 X 2.5	10/120	-
0630161620	16 X 16 X 2.0	10/100	-
0630161622	16 X 16 X 2.2	10/100	-
0630181820	18 X 18 X 2.0	10/80	-
0630181825	18 X 18 X 2.5	10/80	-
0630202020	20 X 20 X 2.0	10/80	-
0630222230	22 X 22 X 3.0	5/60	-
0630282830	28 X 28 X 3.0	30	-
0630323230	32 X 32 X 3.0	30	-

Brryl femër për PE-X
0710

Brryl mashkull për PE-X
0720

Brryl i dyfishte për PE-X
0730

Kodi	Përmasat	Sasia	Cmimi
0610150425	15 X 2.5 X 1/2"	10/120	-
0610160421	16 X 2.0 X 1/2"	10/120	-
0610160422	16 X 2.2 X 1/2"	10/120	-
0610180420	18 X 2.0 X 1/2"	10/100	-
0610180425	18 X 2.5 X 1/2"	10/100	-
0610180620	18 X 2.0 X 3/4"	10/100	-
0610180625	20 X 2.0 X 1/2"	10/100	-

Kodi	Përmasat	Sasia	Cmimi
0620150425	15 X 2.5 X 1/2"	10/120	-
0620160421	16 X 2.0 X 1/2"	10/120	-
0620160422	16 X 2.2 X 1/2"	10/120	-
0620180420	18 X 2.0 X 1/2"	10/100	-
0620180425	18 X 2.5 X 1/2"	10/100	-
0620180620	18 X 2.0 X 3/4"	10/100	-
0620180625	20 X 2.0 X 1/2"	10/100	-

Kodi	Përmasat	Sasia	Cmimi
0630151525	15 X 15 X 2.5	10/120	-
0630161620	16 X 16 X 2.0	10/100	-
0630161622	16 X 16 X 2.2	10/100	-
0630181820	18 X 18 X 2.0	10/80	-
0630181825	18 X 18 X 2.5	10/80	-
0630202020	20 X 20 X 2.0	10/80	-
0630222230	22 X 22 X 3.0	5/60	-

Ti femer për PE-X

0810



Kodi	Përmasat	Sasia	Cmimi
0810150425	15 X 2.5 X 1/2"	10/80	-
0810160420	16 X 2.0 X 1/2"	10/80	-
0810180420	18 X 2.0 X 1/2"	10/60	-
0810180425	18 X 2.5 X 1/2"	10/60	-
0810220630	22 X 3.0 X 3/4"	5/40	-
0810280830	28 X 3.0 X 1"	5/20	-
0810320830	32 X 3.0 X 1"	5/15	-

Ti e dyfishte për PE-X

0810



Kodi	Përmasat	Sasia	Cmimi
0830151525	15 X 2.5 X 15	10/80	-
0830161620	16 X 16 X 2.0	10/80	-
0830181820	18 X 2.0 X 18	10/50	-
0830181825	18 X 2.5 X 18	10/50	-
0830222230	22 X 3.0 X 22	5/40	-
0830282830	28 X 3.0 X 28	5/20	-
0830323230	32 X 3.0 X 32	5/15	-

Pllakë Muri Brryl Femër për PE-X

0740



Kodi	Përmasat	Sasia	Cmimi
0740150425	15 X 2.5 X 1/2"	10/70	-
0740160420	16 X 2.0 X 1/2"	10/70	-
0740180420	18 X 2.0 X 1/2"	10/70	-
0740180425	18 X 2.5 X 1/2"	10/70	-

Nxjerrës tubash

0640



Kodi	Përmasat	Sasia	Cmimi
0640152500	15 X 2.5	1/100	-
0640162000	16 X 2.0	1/100	-
0640182000	18 X 2.0	1/100	-
0640182500	18 X 2.5	1/100	-

Stafe me dopio piaster PE-X

0850



Kodi	Përmasat	Sasia	Cmimi
0850241909	1/2" - 24 x19	1/40	-

Rakord i drejte mashkull per AL PEX
 0611

Kodi	Përmasat	Sasia	Cmimi
0611160420	16 X 2.0 X 1/2"	10/120	-
0611180420	18 X 2.0 X 1/2"	10/100	-
0611200420	20 X 2.0 X 1/2"	10/100	-
0611260830	26 X 3.0 X 1"	5/50	-
0611320830	32 X 3.0 X 1"	5/40	-

Rakord i drejte femer per AL PEX
 0621

Kodi	Përmasat	Sasia	Cmimi
0621160420	16 X 2.0 X 1/2"	10/120	-
0621180420	18 X 2.0 X 1/2"	10/100	-
0621200420	20 X 2.0 X 1/2"	10/100	-
0621260830	26 X 3.0 X 1"	5/50	-
0621320830	32 X 3.0 X 1"	5/40	-

Rakord i drejte i dyfishte per AL PEX
 0631

Kodi	Përmasat	Sasia	Cmimi
0631161620	16 X 2.0 X 16	10/80	-
0631181820	18 X 2.0 X 18	10/80	-
0631202020	20 X 2.0 X 20	10/60	-
0631262630	26 X 3.0 X 26	10/60	-
0631323230	32 X 3.0 X 32	5/40	-

Brryl femër për AL PEX
 0711

Kodi	Përmasat	Sasia	Cmimi
0711160420	16 X 2.0 X 1/2"	10/100	-
0711180420	18 X 2.0 X 1/2"	10/80	-

Brryl mashkull për AL PEX
 0721

Kodi	Përmasat	Sasia	Cmimi
0721160420	16 X 2.0 X 1/2"	10/100	-
0721180420	18 X 2.0 X 1/2"	10/100	-

Brryl i dyfishtë për AL PEX
 0731

Kodi	Përmasat	Sasia	Cmimi
0731161620	16 X 2.0 X 16	10/100	-
0731161620	18 X 2.0 X 18	10/80	-

Ti femer për AL PEX
 0811

Kodi	Përmasat	Sasia	Cmimi
0811160420	16 X 2.0 X 1/2"	10/80	-
0811180420	18 X 2.0 X 1/2"	10/60	-

Ti e dyfishtë për AL PEX
 0831

Kodi	Përmasat	Sasia	Cmimi
0831161620	16 X 2.0 X 16	10/80	-
0831181820	18 X 2.0 X 18	10/50	-

Pllakë Muri Brryl Femër për AL PEX
 0831

Kodi	Përmasat	Sasia	Cmimi
0741160420	16 x 2.0 X 1/2"	10/70	-
0741180420	18 X 2.0 X 1/2"	10/70	-

Set / montim kryq me $\Phi 22$
4011



Kodi	Përmasat	Sasia	Cmimi
4011000020	-	50	-

Montim kryq me bashkim $\Phi 22$
4011



Kodi	Përmasat	Sasia	Cmimi
4011000022	-	100	-

Sonda e sensorit të temperaturës me
unazë bakri , 4010



Kodi	Përmasat	Sasia	Cmimi
4010041211	1/2"	150	-

Unazë bakri per ventilatorë
4010



Kodi	Përmasat	Sasia	Cmimi
4010010004	1/2"	10/500	-

Brryl bronxi
1110

Kodi	Përmasat	Sasia	Cmimi
1110040407	1/2"	10/100	-
1110040479	1/2"	10/100	-
1110060607	3/4"	10/60	-
1110080807	1"	5/40	-
1110101007	1 1/4"	25	-
1110121207	1 1/2"	20	-
1110161607	2"	10	-

Brryl bronxi
1120

Kodi	Përmasat	Sasia	Cmimi
1120040417	1/2"	10/100	-
1120040479	1/2"	10/100	-
1120060607	3/4"	10/60	-
1120080807	1"	5/40	-
1120101007	1 1/4"	25	-
1120121207	1 1/2"	20	-
1120161607	2"	10	-

Ti bronxi
1130

Kodi	Përmasat	Sasia	Cmimi
1130040407	1/2"	10/80	-
1130040479	1/2"	10/80	-
1130060607	3/4"	10/50	-
1130080807	1"	5/30	-
1130101007	1 1/4"	20	-
1130121207	1 1/2"	16	-
1130161607	2"	10	-

Manikote
1140

Kodi	Përmasat	Sasia	Cmimi
1140040000	1/2"	10/150	-
1140060000	3/4"	10/100	-
1140080000	1"	10/70	-
1140100000	1 1/4"	5/40	-

Manikote reduktues
1150

Kodi	Përmasat	Sasia	Cmimi
1150040300	1/2" - 3/8"	10/250	-
1150060407	3/4" - 1/2"	10/150	-
1150080407	1" - 1/2"	10/100	-
1150080607	1" - 3/4"	10/80	-
1150100807	1 1/4" - 1"	10/50	-

Reduksion bronxi
1230

Kodi	Përmasat	Sasia	Cmimi
1230040607	3/4" - 1/2"	10/250	-
1230040807	1" - 1/2"	10/150	-
1230060807	1" - 3/4"	10/150	-
1230041000	1 1/4" - 1/2"	5/80	-
1230061000	1 1/4" - 3/4"	5/80	-

Reduksion bronxi
1230

Kodi	Përmasat	Sasia	Cmimi
1230081007	1 1/4" - 1"	10/80	-
1230041200	1 1/2" - 1/2"	5/50	-
1230061200	1 1/2" - 3/4"	5/50	-
1230081200	1 1/2" - 1"	5/50	-
1230101200	1 1/2" - 11/4"	5/50	-

Reduksion bronxi
1230

Kodi	Përmasat	Sasia	Cmimi
1230041607	2" - 1/2"	5/40	-
1230081607	2" - 1"	5/30	-
1230101600	2" - 1 1/4"	5/40	-
1230121600	2" - 1 1/2"	5/40	-

Nipel reduktuese

1220



Kodi	Përmasat	Sasia	Cmimi
1220030407	1/2" X 3/8"	10/300	-
1220030401	1/2" X 3/8" w	10/300	-
1220030479	1/2" X 3/8"	10/300	-
1220030409	1/2" X 3/8"	10/300	-
1220040607	3/4" X 1/2"	10/200	-
1220040600	3/4" X 1/2"	10/200	-
1220040807	1" X 1/2"	10/100	-
1220060807	1" X 3/4"	10/100	-
1220410007	1 1/4" X 1/2"	10/80	-
1220061007	1 1/4" X 3/4"	10/60	-
1220081007	1 1/4" X 1"	5/10	-

Nipel e dyfishte

1210



Kodi	Përmasat	Sasia	Cmimi
1210040406	1/2" - 1/2"	10/200	-
1210040417	1/2" - 1/2"	10/200	-
1210040479	3/4" - 3/4"	10/200	-
1210060608	1" - 1"	10/150	-
1210060617	1 1/4" - 1 1/4"	10/150	-
1210080807	1 1/2" - 1 1/2"	10/80	-
1210101007	2" - 2"	5/40	-
1210121207	1 1/2" - 1 1/2"	5/30	-
1210161607	2" - 2"	5/20	-

Bashkues Hexagonal M/F

1240



Kodi	Përmasat	Sasia	Cmimi
1240030477	1/2" - 3/8"	10/300	-
1240030400	1/2" - 3/8" w	10/300	-
1240030479	1/2" - 3/8"	10/300	-
1240030409	1/2" - 3/8"	10/300	-
1240047700	1/2" - 1/2"	10/200	-
1240047709	1/2" - 1/2"	10/200	-
1240060670	3/4" - 3/4"	10/150	-
1240060679	3/4" - 3/4"	10/150	-
1240080470	1" - 1/2"	10/100	-
1240080479	1" - 1/2"	10/100	-
1240080670	1" - 3/4"	10/100	-

Bashkues Hexagonal M/F

1240



Kodi	Përmasat	Sasia	Cmimi
1240080679	1" - 3/4"	10/100	-
1240080870	1" - 1"	10/100	-
1240080879	1" - 1"	10/100	-

Bashkues M/F i kromuar

1250



Kodi	Përmasat	Sasia	Cmimi
1250040000	1/2" x 25	10/250	-
1250040900	1/2" x 25	10/250	-
1250040710	1/2" x 40	10/150	-
1250040719	1/2" x 40	10/150	-
1250040000	1/2" x 25	10/250	-

Bisht me dado të lirshme (çift)

1330



Kodi	Përmasat	Sasia	Cmimi
1330040601	1/2" x 3/4" short	2/75	-
1330040602	18 X 2.0 X 1/2"	2/60	-
1330080601	1" x 3/4"	2/40	-
1330040601	1/2" x 3/4" short	2/75	-
1330040602	18 X 2.0 X 1/2"	2/60	-

Bashkues Hexagonal M/F

1240



Kodi	Përmasat	Sasia	Cmimi
1240040000	1/2" - 1/2"	10/250	-
1240040900	1/2" - 1/2"	10/250	-
1240060400	3/4" - 1/2"	10/200	-
1240060409	3/4" - 1/2"	10/200	-

Dado

1340



Kodi	Përmasat	Sasia	Cmimi
1340040007	1/2"	10/500	-
1340060007	3/4"	10/300	-
1340080007	1"	10/200	-
1340100007	1 1/4"	10/120	-
1340120007	1 1/2"	10/100	-
1340160007	2"	5/50	-

Zgjatues DIN 1/2"

1380



Kodi	Përmasat	Sasia	Cmimi
1380100401	1/2" x 10	10/300	-
1380150401	1/2" x 15	10/250	-
1380200401	1/2" x 20	10/200	-
1380250401	1/2" x 25	10/200	-
1380300401	1/2" x 30	10/150	-
1380400401	1/2" x 40	10/100	-
1380500401	1/2" x 50	10/100	-
1380650401	1/2" x 65	10/80	-
1380800401	1/2" x 80	5/70	-
1380100041	1/2" x 100	5/50	-

Zgjatues DIN 3/4"

1380



Kodi	Përmasat	Sasia	Cmimi
1380100601	3/4" x 10	10/200	-
1380150601	3/4" x 15	10/150	-
1380200601	3/4" x 20	10/150	-
1380250601	3/4" x 25	10/100	-
1380300601	3/4" x 30	10/100	-
1380400601	3/4" x 40	10/80	-
1380500601	3/4" x 50	10/80	-
1380650601	3/4" x 65	10/60	-
1380800601	3/4" x 80	5/50	-
1380100061	3/4" x 100	5/50	-

Zgjatues 1/2" I kromuar

1380



Kodi	Përmasat	Sasia	Cmimi
1380100400	1/2" x 10	10/300	-
1380150400	1/2" x 15	10/250	-
1380200400	1/2" x 20	10/200	-
1380250400	1/2" x 25	10/200	-
1380300400	1/2" x 30	10/150	-
1380400400	1/2" x 40	10/100	-
1380500400	1/2" x 50	10/100	-
1380650400	1/2" x 65	10/80	-
1380800400	1/2" x 80	5/70	-
1380100040	1/2" x 100	5/50	-

Zgjatues 3/4" I kromuar

1380



Kodi	Përmasat	Sasia	Cmimi
1380100600	3/4" x 10	10/200	-
1380150600	3/4" x 15	10/150	-
1380200600	3/4" x 20	10/150	-
1380250600	3/4" x 25	10/100	-
1380300600	3/4" x 30	10/100	-

Zgjatues 3/4" I kromuar

1380



Kodi	Përmasat	Sasia	Cmimi
1380400600	3/4" x 40	10/80	-
1380500600	3/4" x 50	10/80	-
1380650600	3/4" x 65	10/60	-
1380800600	3/4" x 80	5/50	-
1380100060	3/4" x 100	5/50	-

Brryl femer

1110



Kodi	Përmasat	Sasia	Cmimi
1110040402	1/2"	10/150	-
1110040409	1/2" I Kromuar	10/150	-
1110060602	3/4"	10/100	-
1110080802	1"	10/50	-
1110040402	1/2"	10/150	-

Brryl mashkull-femer

1120



Kodi	Përmasat	Sasia	Cmimi
1120040403	1/2"	10/150	-
1120040409	1/2" I Kromuar	10/150	-
1120060602	3/4"	10/100	-
1120080802	1"	10/50	-

Ti femer

1130



Kodi	Përmasat	Sasia	Cmimi
1130040402	1/2"	10/100	-
1130040409	1/2" I Kromuar	10/100	-
1130060602	3/4"	10/50	-
1130080802	1"	5/40	-

Manikote F-F

1140



Kodi	Përmasat	Sasia	Cmimi
1140010000	1/8"	10/300	-
1140020000	1/4"	10/500	-
1140030000	3/8"	10/300	-
1140040002	1/2"	10/200	-

Manikote F-F
 1140

Kodi	Përmasat	Sasia	Cmimi
1140060004	3/4"	10/150	-
1140080002	1"	10/100	-
1140120000	1 1/2"	5/30	-
1140160000	2"	5/20	-

Manikote reduktuese
 1150

Kodi	Përmasat	Sasia	Cmimi
1150100400	1 1/4" - 1/2"	5/80	-
1150100600	1 1/4" - 3/4"	10/50	-
1150120800	1 1/2" - 1"	5/40	-
1150121000	1 1/2" - 1 1/4"	5/30	-

Manikote reduktuese
 1150

Kodi	Përmasat	Sasia	Cmimi
1150161000	2" - 1 1/4"	5/20	-
1150161200	2" - 1 1/2"	5/20	-
			-
			-

Reduktues M- F
 1230

Kodi	Përmasat	Sasia	Cmimi
1230010200	1/4" - 1/8"	10/100 0	-
1230010300	3/8" - 1/8"	10/500	-
1230020300	3/8" - 1/4"	10/500	-
1230010400	1/2" - 1/8"	10/400	-
1230020400	1/2" - 1/4"	10/400	-
1230030400	1/2" - 3/8" Kromuar	10/400	-
1230030409	1/2" - 3/8"	10/400	-
1230040601	3/4" - 1/2"	10/300	-
1230040600	3/4" - 1/2" Kromuar	10/300	-
1230040800	1" - 1/2"	10/300	-
1230060800	1" - 3/4"	10/200	-

Nipel reduktuese
 1220

Kodi	Përmasat	Sasia	Cmimi
1220010200	1/4" - 1/8"	10/600	-
1220020300	3/8" - 1/4"	10/400	-
1220020400	1/2" - 1/4"	10/400	-
1220020402	1/2" - 1/4" cone	10/400	-
1220040602	3/4" - 1/2"	10/200	-
1220040802	1" - 1/2"	10/150	-
1220060802	1" - 3/4"	10/100	-
1220081002	1 1/4" - 1"	10/60	-
1220061200	1 1/2" - 3/4"	5/60	-
1220081200	1 1/2" - 1"	5/50	-
1220101200	1 1/2" - 1 1/4"	5/50	-
1220161000	2" - 1"	5/30	-
1220101600	2" - 1 1/4"	5/30	-
1220121600	2" - 1 1/2"	5/30	-

Nipel e dyfishte
 1210

Kodi	Përmasat	Sasia	Cmimi
1210010100	1/8" - 1/8"	10/100 0	-
1210110100	1/8" - 1/8" cone	10/100 0	-
1210020200	1/4" - 1/4"	10/750	-
121002020K	1/4" - 1/4" cone	10/700	-
1210030309	3/8" - 3/8"	10/500	-
1210040402	1/2" - 1/2"	10/250	-
1210040409	1/2" - 1/2" Kromuar	10/250	-
1210060607	3/4" - 3/4"	10/200	-
1210080800	1" - 1"	10/100	-
1210101002	1 1/4" - 1 1/4"	10/50	-
1210121202	1 1/2" - 1 1/2"	5/40	-
1210161602	2" - 2"	5/20	-

Tapa bronxi
 1310

Kodi	Përmasat	Sasia	Cmimi
1310040700	1/2"	10/350	-
1310060700	3/4"	10/250	-
1310080700	1"	10/150	-
1310080709	1"	10/150	-
1310100700	1 1/4"	10/100	-
1310120700	1" 1/2"	10/80	-

 Tapa bronxi
 1320

Kodi	Përmasat	Sasia	Cmimi
1320040000	1/2"	10/300	-
1320060000	3/4"	10/250	-
1320080001	1"	10/150	-
1320080900	1"	10/150	-
1320100000	1 1/4"	10/100	-
1320120000	1 1/2"	5/50	-

 Tapa bronxi
 1310

Kodi	Përmasat	Sasia	Cmimi
1310010000	1/8"	10/800	-
1310020000	1/4"	10/1000	-
1310030000	3/8"	10/500	-
1310040002	1/2"	10/400	-

 Tapa bronxi
 1310

Kodi	Përmasat	Sasia	Cmimi
1310060002	3/4"	10/250	-
1310080002	1"	10/150	-
1310080092	1"	10/150	-
1310160000	2"	5/50	-

 Tapa bronxi
 1320

Kodi	Përmasat	Sasia	Cmimi
1320010000	1/8"	10/500	-
1320020000	1/4"	10/1000	-
1320030000	3/8"	10/700	-
132004000E	1/2"	10/500	-

 Tapa bronxi
 1320

Kodi	Përmasat	Sasia	Cmimi
132004090E	1/2"	10/500	-
1320060001	3/4"	10/300	-
1320080000	1"	10/150	-
1320160000	2"	5/40	-

 Tapa bronxi
 1320

Kodi	Përmasat	Sasia	Cmimi
1320040001	1/2"	10/400	-
132004090T	1/2" kromuar	10/400	-

Bashkues 1930



Kodi	Përmasat	Sasia	Cmimi
1390040300	1/2"	10/120	-
1390060400	3/4"	10/80	-

 Bashkues
 1930

Kodi	Përmasat	Sasia	Cmimi
1390080600	1"	10/50	-
1390101000	1 1/4"	5/25	-

 Bashkues
 1930

Kodi	Përmasat	Sasia	Cmimi
1390121200	1 1/4"	5/20	-
1390161600	1 1/2"	5/15	-

 Ti me pesë drejtime
 1360

Kodi	Përmasat	Sasia	Cmimi
1360820800	82 x 1"	5/30	-
1360920800	92 x 1"	5/30	-

 Tape bronxi
 1325

Kodi	Përmasat	Sasia	Cmimi
1325040000	1/2"	10/100	-

Zgjatues hexagonal 1/2"

1280



Kodi	Përmasat	Sasia	Cmimi
1280100400	1/2" x 10	10/300	-
1280150400	1/2" x 15	10/250	-
1280200400	1/2" x 20	10/200	-
1280250400	1/2" x 25	10/200	-
1280300400	1/2" x 30	10/150	-
1280400400	1/2" x 40	10/100	-
1280500400	1/2" x 50	10/100	-

Zgjatues hexagonal 1/2"

1360



Kodi	Përmasat	Sasia	Cmimi
1280100409	1/2" x 10	10/300	-
1280150409	1/2" x 15	10/250	-
1280200409	1/2" x 20	10/200	-
1280250409	1/2" x 25	10/200	-
1280300409	1/2" x 30	10/150	-
1280400409	1/2" x 40	10/100	-
1280500409	1/2" x 50	10/100	-

Rakord per tub pe-x

1810



Kodi	Përmasat	Sasia	Cmimi
1810040000	1/2"	10/350	-
1810060000	3/4"	10/250	-
1810080000	1"	10/150	-
1810100000	1 1/4"	10/150	-
1810120000	1 1/2"	10/100	-
1810160000	2"	10/80	-

Tub/zorre bashkuese femer

1820



Kodi	Përmasat	Sasia	Cmimi
1320040000	1/2"	10/300	-
1320060000	3/4"	10/250	-
1320080001	1"	10/150	-
1320080900	1 1/4"	10/150	-
1320100000	1 1/2"	10/100	-
1320120000	2"	5/50	-

Tub Nipel M - M 1/2"

1260



Kodi	Përmasat	Sasia	Cmimi
1260040500	1/2" x 50	10/150	-
1260040600	1/2" x 60	10/150	-
1260040700	1/2" x 70	10/150	-
1260040800	1/2" x 80	10/100	-
1260041000	1/2" x 100	10/100	-
1260041500	1/2" x 150	5/80	-
1260042000	1/2" x 200	5/50	-

Tub Nipel M - M 1/2"

1260



Kodi	Përmasat	Sasia	Cmimi
1260060600	3/4" x 60	10/100	-
1260060700	3/4" x 70	10/80	-
1260060800	3/4" x 80	5/70	-
1260061000	3/4" x 100	5/50	-
1260061500	3/4" x 150	5/50	-
1260062000	3/4" x 200	5/40	-
1260060600	3/4" x 60	10/100	-

Tub Nipel M - M 1"

1260



Kodi	Përmasat	Sasia	Cmimi
1260080600	1/2"	10/350	-
1260080100	3/4"	10/250	-
1260080150	1"	10/150	-
1260082000	1"	10/150	-
1260080600	1/2"	10/350	-

Tub Nipel M - M 1 1/4" - 2"

1260



Kodi	Përmasat	Sasia	Cmimi
1320040000	1/2"	10/300	-
1320060000	3/4"	10/250	-
1320080001	1"	10/150	-

Nipel drejtuese

1270



Kodi	Përmasat	Sasia	Cmimi
1270040600	1/2" x 60	10/150	-
1270041000	1/2" x 100	10/100	-
1270060600	3/4" x 60	10/100	-
1270061000	3/4" x 100	10/60	-
1270081000	1" x 100	5/40	-

SALDIM/TEFLON/FISHEKE

Saldim i butë për tub bakri 97/3
2410



Pastrues për tub bakri Cher FLUX
2420



Teflon
2510



Kodi	Përmasat	Sasia	Cmimi
2410970300	2.5mm/0.20kg	1/60	-

Kodi	Përmasat	Sasia	Cmimi
2420000000	4 oz	1/60	-

Kodi	Përmasat	Sasia	Cmimi
2510041000	1/2"x12m	10/250	-

Teflon
2510



Fisheke te tipit "Grohe"
2310



Fisheke te tipit "Normal"
2310



Kodi	Përmasat	Sasia	Cmimi
2510061000	3/4"x12m	10/80	-

Kodi	Përmasat	Sasia	Cmimi
2310040000	1/2"	10/250	-

Kodi	Përmasat	Sasia	Cmimi
2310030000	3/8"	10/300	-

Panele Diellore

Ngrohje & Ftohje

Hidraulike

Hidrosanitare

Aksesore të ndryshëm

bonomi Saracineska

Saracineskë me Hollandez



Kodi	Përmasat	Sasia	Cmimi
76500004R	1/2"	1/150	-
76500006R	3/4"	1/100	-
76500008R	1"	1/72	-
76500010R	1 1/4"	1/30	-
76500111R	1 1/2"	1/30	-
76500113R	2"	1/30	-

Saracineskë Kendore me Hollandez



Kodi	Përmasat	Sasia	Cmimi
76600006R	3/4"	1/60	-
76600004R	1/2"	1/40	-
76600008R	1"	1/40	-

Saracineskë Këndore me Hollandez



Kodi	Përmasat	Sasia	Cmimi
76600008B	1"	1/60	-

Saracineskë F-F me Leve



Kodi	Përmasat	Sasia	Cmimi
77500204R	1/2"	1/60	-
77500206R	3/4"	1/40	-
77500208R	1"	1/40	-

Saracineskë M-F me Leve



Kodi	Përmasat	Sasia	Cmimi
77490008R	1"	1/240	-
77490004R	1/2"	1/150	-
77490006R	3/4"	1/100	-

Saracineskë Flutur M-F



Kodi	Përmasat	Sasia	Cmimi
76070004R	1/2"	1/250	-
76070006R	3/4"	1/200	-
76070008R	1"	1/120	-

Saracineskë F-F Flutur



Kodi	Përmasat	Sasia	Cmimi
76020004R	1/2"	1/250	-
77500004R	1/2"	1/200	-
77500006R	3/4"	1/120	-
77500008R	1"	1/100	-

Saracineskë F-F me Leve



Kodi	Përmasat	Sasia	Cmimi
76000204R	1/2"	1/250	-
76000206R	3/4"	1/200	-
76000210R	1 1/4"	1/120	-
76000211R	1 1/2"	1/100	-
76000213R	2"	1/60	-

Saracineskë M-F me Leve



Kodi	Përmasat	Sasia	Cmimi
77490204R	1/2"	1/250	-
77490206R	3/4"	1/150	-
77490208R	1"	1/120	-
76050211R	1 1/2"	1/100	-
76050213R	2"	1/100	-

b bonomi Saracineska, Buketona, Tapa, Cezme, Brryl

Saracineskë Flutur



Kodi	Përmasat	Sasia	Cmimi
86401616	fi 16X16	1/20	-
86402020	fi 20X20	1/10	-

Buketon kolektori



Kodi	Përmasat	Sasia	Cmimi
39801604	16.02x1/2"	1/240	-
39801605	4*19*16	1/150	-

Saracineskë F-F me Leve Rrethore



Kodi	Përmasat	Sasia	Cmimi
7520A011	1 1/2"	1/240	-
7520A013	2"	1/150	-

Cezme me Levë



Kodi	Përmasat	Sasia	Cmimi
73000204R	1/2"	1/240	-
73000206R	3/4"	1/150	-
73000208R	1"	1/240	-

Cezme Flutur



Kodi	Përmasat	Sasia	Cmimi
73500006R	1/2"	1/240	-
73500008R	3/4"	1/150	-

Saracineskë Flutur



Kodi	Përmasat	Sasia	Cmimi
86412006	fi 20x3/4"	1/240	-

Cezme



Kodi	Përmasat	Sasia	Cmimi
35701004	1/2"	1/80	-

Cezme



Kodi	Përmasat	Sasia	Cmimi
37121104	1/2"	1/80	-

Tapë Bronxi



Kodi	Përmasat	Sasia	Cmimi
37400006L910	3/4"	1/250	-
37400008L910	1"	1/100	-

Tapë Bronxi



Kodi	Përmasat	Sasia	Cmimi
19000004XA	1/2"	1/250	-
19000006XA	3/4"	1/100	-
19000008XA	1"	1/80	-

Brryl Hollandez M-F



Kodi	Përmasat	Sasia	Cmimi
36600006	3/4"	1/150	-
36600008	1"	1/100	-

Hollandez Bronxi M-F



Kodi	Përmasat	Sasia	Cmimi
36610004	1/2"	1/250	-
36610006	3/4"	1/100	-
36610008	1"	1/80	-

bonomi Detentor kaloriferi, Kolektor, Kondravalvol, Filter, Saracineske

Detentor Kaloriferi



Kodi	Përmasat	Sasia	Cmimi
56110504	24x19 -1/2"	1/150	-
56110404	16x1/2	1/100	-

Koke termostatike



Kodi	Përshkrimi	Sasia	Cmimi
56140002	Koke termostatike	1/100	-

Kondravalvol Europa



Kodi	Përmasat	Sasia	Cmimi
10000004	1/2"	1/200	-
10000006	3/4"	1/150	-
10000008	1"	1/100	-
10000010	1 1/4"	1/80	-
10000013	2"	1/60	-
10000012	1 1/2"	1/20	-

Filter bronxi



Kodi	Përmasat	Sasia	Cmimi
19050010	1 1/4"	1/80	-
19050011	1 1/2"	1/60	-
19050013	2"	1/20	-

Rakord me hollandez-gazi me saldime



Kodi	Përshkrimi	Sasia	Cmimi
44061606	16x2.0	1/20	-

Detentor Kaloriferi



Kodi	Përmasat	Sasia	Cmimi
56050504	24x19 -1/2"	1/150	-

Saracineskë Murore



Kodi	Përmasat	Sasia	Cmimi
80020004	1/2x1/2	1/20	-

Kolektor i nikeluar



Kodi	Përmasat	Sasia	Cmimi
37450208W	1" x16*2*2D	1/20	-
37450308W	1" x16*2*3D	1/15	-
37450408W	1" x16*2*4D	1/10	-

Kondravalvol dushi



Kodi	Përmasat	Sasia	Cmimi
36360004	1/2"	1/80	-
36360006	3/4"	1/60	-

Detentor Kaloriferi



Kodi	Përmasat	Sasia	Cmimi
56070504	24x19 -1/2"	1/150	-

Kondravalvol dushi



Kodi	Përshkrimi	Sasia	Cmimi
79491606	fi 16	1/20	-

Site pusi



Kodi	Përmasat	Sasia	Cmimi
19200006	3/4"	1/80	-
19200010	1 1/4"	1/60	-
19200011	1 1/2"	1/40	-
19200013	2"	1/20	-
19200008	1"	1/10	-

Saracineskë gazi inkaso



Kodi	Përmasat	Sasia	Cmimi
79410000	1/2"x3/4"x1"	1/20	-



Solin-Tub pe-x



Kodi	Përshkrimi	Cmimi
SOL022	Tub pe-x I zi me shllang blu Ø16x2	-

Solin-Tub pe-x



Kodi	Përshkrimi	Cmimi
SOL023	Tub pe-x I zi me shllang blu Ø18x2	-

Solin-Tub pe-x



Kodi	Përshkrimi	Cmimi
SOL024	Tub pe-x I zi me shllang blu Ø22x3	-

Solin-Tub pe-x



Kodi	Përshkrimi	Cmimi
SOL025	Tub pe-x I zi me shllang te kuq Ø16x2	-

Solin-Tub pe-x



Kodi	Përshkrimi	Cmimi
SOL026	Tub pe-x I zi me shllang te kuq Ø18x2	-

Solin-Tub pe-x



Kodi	Përshkrimi	Cmimi
SOL027	Tub pe-x I zi me shllang te kuq Ø22x3	-

Solin-Tub pe-x



Kodi	Përshkrimi	Cmimi
SOL020	Tub pe-x I kuq oksigjeni me shllang te kuq Ø16x2	-

Solin-Tub pe-x



Kodi	Përshkrimi	Cmimi
SOL029	Tub pe-x NOXY I kuq me shllang te kuq Ø16x2	-

Solin-Tub pe-x



Kodi	Përshkrimi	Cmimi
SOL019	Tub pe-x I kuq oksigjeni me shllang blu Ø16x2	-

Solin-Tub pe-x



Kodi	Përshkrimi	Cmimi
SOL028	Tub pe-x NOXY I kuq me shllang blu Ø16x2	-

Solin-Tub pe-x



Kodi	Përshkrimi	Cmimi
SOL017	Tub pe-x gri me shllang blu Ø16x2	-

Solin-Tub pe-x



Kodi	Përshkrimi	Cmimi
SOL018	Tub pe-x gri me shllang te kuq Ø16x2	-

Solin-Tub pe-x



Kodi	Përshkrimi	Cmimi
SOL016	Tub me termoizolim Retiflex Ø18x2	-

Solin-Tub pe-x



Kodi	Përshkrimi	Cmimi
SOL030	Tub pex-al-pex alper-therm Ø16x2	-

Solin-Tub pe-x



Kodi	Përshkrimi	Cmimi
SOL044	Tub pe-x I zi pa shllang Ø16x2	-

Solin-Tub pe-x



Kodi	Përshkrimi	Cmimi
SOL045	Tub pe-x I zi pa shllang Ø22x3	-

Solin-Tub pe-x



Kodi	Përshkrimi	Cmimi
SOL021	Tub pe-x I kuq oksigjen per sistem dyshemeje Ø16x2	-

Solin-Tub pe-x



Kodi	Përshkrimi	Cmimi
SOL041	Tub pe-x I kuq oksigjen per sistem dyshemeje Ø17x2	-

Solin-Tub



Kodi	Përshkrimi	Cmimi
SOL033	Tub Solidrain Ø40x32	-

Solin-Tub



Kodi	Përshkrimi	Cmimi
SOL038	Tub Solidrain Ø57x50	-

Solin-Tub



Kodi	Përshkrimi	Cmimi
SOL042	Tub kondicioneri guain Ø20x16	-

Solin-Tub



Kodi	Përshkrimi	Cmimi
SOL043	Tub kondicioneri guain Ø22x18	-

Solin- Veshje tubi



Kodi	Përshkrimi	Cmimi
SOL036	Veshje tubi Ø10x8 sani flex e bardhe	-

Solin- Veshje tubi



Kodi	Përshkrimi	Cmimi
SOL047	Veshje tubi Ø10x8 sani flex gri	-

Solin-Tub



Kodi	Përshkrimi	Cmimi
SOL031	Tub sani fleex Ø10x1.4 RETIFLEX	-

Solin-Tub



Kodi	Përshkrimi	Cmimi
SOL032	Tub sani fleex Ø8x1 OCTATHERM	-

Solin-Brryl



Kodi	Përshkrimi	Cmimi
SOL001	Brryl fundor solidrain Ø50x32	-

Solin-Rakord



Kodi	Përshkrimi	Cmimi
SOL004	Rakord Solidrain Ø40x32	-

Solin-Rakord



Kodi	Përshkrimi	Cmimi
SOL040	Rakord Solidrain Ø57x50	-

Solin-Ura



Kodi	Përshkrimi	Cmimi
SOL034	Ura solidrain Ø32x1.1/2	-

Solin-Ura



Kodi	Përshkrimi	Cmimi
SOL035	Ura solidrain Ø32x1.1/4	-

Solin-Silikon



Kodi	Përshkrimi	Cmimi
SOL037	Silikon solidrain 310 ml	-

Solin-Rakord



Kodi	Përshkrimi	Cmimi
SOL007	Rakord tubi Saniflex Ø8x1/2 m	-

Solin-Rakord



Kodi	Përshkrimi	Cmimi
SOL009	Rakord tubi Saniflex Ø10x1/2 m	-

Solin-Rakord



Kodi	Përshkrimi	Cmimi
SOL048	Rakord tubi Saniflex Ø8x3/8 f	-

Solin-Rakord



Kodi	Përshkrimi	Cmimi
SOL010	Rakord tubi Saniflex Ø10x3/8 f	-

Solin-Rakord



Kodi	Përshkrimi	Cmimi
SOL006	Rakord tubi Saniflex Ø8x1/2 f	-

Solin-Set Rakordesh



Kodi	Përshkrimi	Cmimi
SOL005	Set Rakordesh Ø8x5/8 per tub saniflex per mishelator	-

Solin-Celes



Kodi	Përshkrimi	Cmimi
SOL049	Celes plastic per tub saniflex Ø8x1/2	-

Solin-Celes



Kodi	Përshkrimi	Cmimi
SOL050	Celes plastic per tub saniflex Ø10x1/2	-

Solin-Tapa



Kodi	Përshkrimi	Cmimi
SOL051	Tapa prove 1/2 m me gomin	-

Vidoflex[®]

Your Insulation Partner

TUBA SOLAR & ME VESHJE



Temperaturat e Ambientit
-40 °C tek +180 °C

Aplikacionet

Ngrohje | Hidraulik | Kondicioner | Ftohje | Energji diellore

Veshje tubi

Veshje tubi solar Vidoflex, e bardhe



Kodi	Përmasat	Cmimi
213111209022	9*22	-
213111209028	9*28	-
213111209035	9*35	-
213111209042	9x42	-

Veshje tubi Vidoflex, gri



Kodi	Përmasat	Cmimi
213134509022	9x22	-
2131112090	9*22	-

Veshje tubi Vidoflex, e zeze



Kodi	Përmasat	Cmimi
301001209022	9*22	-
301001209028	9*28	-
301001209035	9*35	-
AS266	9*42	-
301001209048	9*48	-
AS267	9*54	-
301001209060	9*60	-
301001209064	9*64	-
301001209076	9*76	-

Veshje OneFlex



Kodi	Përmasat	Cmimi
D007	6*10	-
D008	6*12	-
D009	6*15	-
D010	6*18	-
D011	6*22	-
D012	6*28	-
D013	6*35	-
D014	9*15	-
D015	9*28	-
D016	9*35	-
D017	9*42	-
D018	9*54	-

Veshje OneFlex



Kodi	Përmasat	Cmimi
D019	9*60	-
D020	9*76	-
D021	9*88	-
D068	9*22	-
D070	13*22	-
D071	13*28	-
D072	13*42	-
D073	13*48	-
D074	13*35	-
D090	9*18	-
D091	13*54	-
D092	13*76	-

Veshje OneFlex



Kodi	Përmasat	Cmimi
D093	13*114	-
D094	19*35	-
D095	19*42	-
D096	6mm (1m gjersi)	-
D027	9mm (1m gjersi)	-
D097	13mm (1m gjersi)	-
D098	19mm (1m gjersi)	-
D099	Njgjitës rrote 15ml	-

Panele Diellore

Ngrohje & Ftohje

Hidraulike

Hidrosanitare

Aksesorë të ndryshëm

Tuba, Brryla bakrri

Tub bakrri per kondicioner i veshur

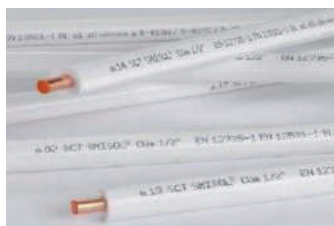

Kodi	Përmasat	Cmimi
77M-1/4X0.8	1/4x0.8 (fi 6)	-
77M-3/8X0.8	3/8x0.8 (fi 10)	-
77M-1/2X0.8	1/2x0.8 (fi 12)	-
77M-5/8X1	5/8x1 (fi 16)	-

Tuba Bakri



Kodi	Përmasat	Cmimi
HAL008	Tub bakri I drejte Ø15x0.7	-
HAL009	Tub bakri I drejte Ø18x0.7	-
HAL010	Tub bakri I drejte Ø22x0.9	-
HAL011	Tub bakri I drejte Ø28x0.8	-

Tuba Bakri



Kodi	Përmasat	Cmimi
HAL013	Tub bakri I drejte Ø42 seanco	-
HAL014	Tub bakri I drejte Ø54 seanco	-
		-
		-

Brryl Bakri



Kodi	Përmasat	Cmimi
HTM001	Brryl bakri f+f 45° Ø28	-
HTM004	Brryl bakri f+f 45° Ø15	-

Brryl Bakri



Kodi	Përmasat	Cmimi
1.25E+12	Brryl bakri f+f 90° Ø15	-
90028	Brryl bakri f+f 90° Ø28	-

Brryl Bakri



Kodi	Përmasat	Cmimi
900351	Brryl bakri f+f 90° Ø35	-
900421	Brryl bakri f+f 90° Ø42	-

Izolant kondicioneri



Kodi	Përmasat	Cmimi
GEN020	20m X 48mm	-

Izolant alumini



Kodi	Përmasat	Cmimi
GEN021	50mmx50m	-

Kembe kondicioneri



Kodi	Përshkrimi	Cmimi
40x40	Kembe kondicioneri xingato (9000 btu – 12000 btu) e bardhe	-

Kembe kondicioneri



Kodi	Përshkrimi	Cmimi
50x50	Kembe kondicioneri xingato (18000 btu – 24000 btu) e bardhe	-

Kembe kondicioneri



Kodi	Përshkrimi	Cmimi
AIR-1PLUS	Kembe kondicioneri & chiller (4cope)	-
AIR-1	Kembe kondicioneri (4cope)	-

wilo





Pompe kaldaje

Wilo-Pompe Kaldaje Star RS



Kodi	Përshkrimi	Cmimi
4032952	Wilo-Pompe kaldaje STAR-RS 25/2 MF	-

Wilo-Pompe Kaldaje Star RS



Kodi	Përshkrimi	Cmimi
4032954	Wilo-Pompe kaldaje STAR-RS 25/4	-

Wilo-Pompe Kaldaje Star RS



Kodi	Përshkrimi	Cmimi
4032956	Wilo-Pompe kaldaje STAR-RS 25/6 MF	-

Wilo-Pompe Kaldaje Star RS



Kodi	Përshkrimi	Cmimi
4033770	Wilo-Pompe kaldaje STAR-RS 30/6 84wat-MF	-

Wilo-Pompe Kaldaje Star RS



Kodi	Përshkrimi	Cmimi
4037311	Wilo-Pompe kaldaje STAR-RS 30/7 147 MF	-

Wilo-Pompe Kaldaje Star RS



Kodi	Përshkrimi	Cmimi
4094375	Wilo-Pompe kaldaje STAR-RS 30/8 151 MF	-

Wilo-Pompe Kaldaje TOP-S



Kodi	Përshkrimi	Cmimi
2044009	Wilo-Pompe kaldaje TOP-S 25/5 Em MF	-

Wilo-Pompe Kaldaje TOP-S



Kodi	Përshkrimi	Cmimi
2044009	Wilo-Pompe kaldaje TOP-S 25/5 (3~400/230 V, PN 10) 3F	-

Wilo-Pompe Kaldaje TOP-S



Kodi	Përshkrimi	Cmimi
2048320	Wilo-Pompe kaldaje TOP-S 25/7 MF	-

Wilo-Pompe Kaldaje TOP-S



Kodi	Përshkrimi	Cmimi
2061962	Wilo-Pompe kaldaje TOP-S 25/10 2061962	-

Wilo-Pompe Kaldaje TOP-S



Kodi	Përshkrimi	Cmimi
2048322	Wilo-Pompe kaldaje TOP-S 30/7 MF	-

Wilo-Pompe Kaldaje TOP-S



Kodi	Përshkrimi	Cmimi
2066132	Wilo-Pompe kaldaje TOP-S 30/10 3F	-



Pompe kaldaje, Pompe veteqarkulluese

Wilo-Pompe Kaldaje TOP-S



Kodi	Përshkrimi	Cmimi
2066132	Wilo-Pompe kaldaje TOP-S 30/10 (1~230 V, PN 10) MF	-

Wilo-Pompe Kaldaje TOP-S



Kodi	Përshkrimi	Cmimi
2165522	Wilo-Pompe kaldaje TOP-S 30/10 (3~400/230 V, PN 10) 3F	-

Wilo-Pompe Kaldaje TOP-S



Kodi	Përshkrimi	Cmimi
2165525	Wilo-Pompe kaldaje TOP-S 40/10 DM PN6/10-3F	-

Wilo-Pompe Kaldaje TOP-S



Kodi	Përshkrimi	Cmimi
2165526	Wilo-Pompe kaldaje TOP-S 40/15 2-SPEEDS (1~230 V, PN 6/10) MF	-

Wilo-Pompe Kaldaje TOP-S



Kodi	Përshkrimi	Cmimi
2080040	Wilo-Pompe kaldaje TOP-S 40/4 MF	-

Wilo-Pompe Kaldaje TOP-S



Kodi	Përshkrimi	Cmimi
2165524	Wilo-Pompe kaldaje TOP-S 40/10 DM PN6/10 me fllanxhe-1F	-

Wilo-Pompe Kaldaje TOP-S



Kodi	Përshkrimi	Cmimi
2165527	Wilo-Pompe kaldaje TOP-S 40/15 DM PN6/10 me fllanxhe-3F	-

Wilo-Pompe Kaldaje TOP-S



Kodi	Përshkrimi	Cmimi
2165544	Wilo-Pompe kaldaje TOP-S 50/7 (3~400/230 V, PN 6/10)	-

Wilo-Pompe Kaldaje TOP-S



Kodi	Përshkrimi	Cmimi
2165533	Wilo-Pompe kaldaje TOP-S 50/15 (3~400/230 V, PN 6/10)	-

Wilo-Pompe Kaldaje TOP-S



Kodi	Përshkrimi	Cmimi
2165538	Wilo-Pompe kaldaje TOP-S 65/13 (3~400/230 V, PN 6/10)	-

Wilo-Pompe Kaldaje TOP-S



Kodi	Përshkrimi	Cmimi
2165544	Wilo-Pompe kaldaje TOP-S 80/10 (3~400/230 V, PN 10)	-

Wilo-Pompe veteqarkulluese



Kodi	Përshkrimi	Cmimi
Wilo-PB	Wilo-Pompe veteqarkulluese 200EA+340wat MF	-

Panele Diellore

Ngrohje & Ftohje

Hidraulike

Hidrosanitare

Aksesore të ndryshëm



Prese kontrolli, Pompe shtepie, Pompe uji

Wilo-Prese Kontrolli



Kodi	Përshkrimi	Cmimi
4190896	Wilo-Prese kontrolli MF HiControl 1	-

Wilo-Pompe Shtepie



Kodi	Përshkrimi	Cmimi
4186197	Wilo-Pompe Shtepie HiPeri 1-4 370w MF	-

Wilo-Pompe Shtepie



Kodi	Përshkrimi	Cmimi
4186198	Wilo-Pompe Shtepie HiPeri 1-5 500w MF	-

Wilo-Pompe Shtepie



Kodi	Përshkrimi	Cmimi
4081221	Wilo-Pompe Shtepie Jet WJ 202 X (1~230 V) MF	-

Wilo-Pompe Shtepie



Kodi	Përshkrimi	Cmimi
4081222	Wilo-Pompe Shtepie Jet WJ 203 X (1~230 V) MF	-

Wilo-Pompe Shtepie



Kodi	Përshkrimi	Cmimi
4143999	Wilo-Pompe Shtepie Jet WJ 204 X (1~230 V) MF	-

Wilo-Pompe Uji



Kodi	Përshkrimi	Cmimi
4210752	Wilo-Pompe Uji Economy MHI 805 (3~400 V, FKM)	-

Wilo-Pompe Shtepie



Kodi	Përshkrimi	Cmimi
4244128	Wilo-Pompe Shtepie HiMulti 3-24/1/5/230-MF	-

Wilo-Pompe Shtepie



Kodi	Përshkrimi	Cmimi
4244129	Wilo-Pompe Shtepie HiMulti 3-25/1/5/230-MF	-

Wilo-Pompe Uji



Kodi	Përshkrimi	Cmimi
4235352	Wilo-Pompe Uji horizontale Medana CH1- L.604-1/E/E/10T	-

Wilo-Pompe Uji



Kodi	Përshkrimi	Cmimi
4233364	Wilo-Pompe Uji horizontale Medana CH1-LC.206-5/E/A/10T	-

Wilo-Pompe Uji



Kodi	Përshkrimi	Cmimi
4233366	Wilo-Pompe Uji horizontale Medana CH1-LC.207-5/E/A/10T	-



Pompe uji

Wilo-Pompe Uji



Wilo-Pompe Uji



Wilo-Pompe Uji



Kodi	Përshkrimi	Cmimi
4233374	Wilo-Pompe Uji horizontale Medana CH1-LC.406-5/E/A/10T-1.1 kw MF	-

Wilo-Pompe Uji

Kodi	Përshkrimi	Cmimi
4233375	Wilo-Pompe Uji horizontale Medana CH1-LC.406-5/E/E/10T	-

Wilo-Pompe Uji

Kodi	Përshkrimi	Cmimi
4233376	Wilo-Pompe Uji horizontale Medana CH1-LC.407-5/E/E/10T-1.1 kw	-

Wilo-Pompe Uji



Kodi	Përshkrimi	Cmimi
4233382	Wilo-Pompe Uji horizontale Medana CH1-LC.606-5/E/E/10T-1.85 kw	-



Kodi	Përshkrimi	Cmimi
4231439	Wilo-Pompe Uji horizontale Medana CH1-LC.1004-5/E/E/10T	-

Wilo-Pompe Uji



Kodi	Përshkrimi	Cmimi
4233385	Wilo-Pompe Uji horizontale Medana CH1-LC.1005-5/E/E/10T-2.5kw	-

Wilo-Pompe Uji

Wilo-Pompe Uji



Kodi	Përshkrimi	Cmimi
4233386	Wilo-Pompe Uji horizontale Medana CH1-LC.1006-5/E/E/10T	-



Kodi	Përshkrimi	Cmimi
4240517	Wilo-Pompe Uji vertikale Medana CV1-L.610-1/E/E/160	-



Kodi	Përshkrimi	Cmimi
4240515	Wilo-Pompe Uji vertikale Medana CV1-L.608-1/E/E/160-2.5 kw	-

Wilo-Pompe Uji



Kodi	Përshkrimi	Cmimi
4240516	Wilo-Pompe Uji vertikale Medana CV1-L.609-1/E/E/160-3 kw	-

Wilo-Pompe Uji



Kodi	Përshkrimi	Cmimi
4201060	Wilo-Pompe Helix First V220-5/25/E/KS/400-50 2.2 kw	-

Wilo-Pompe Uji



Kodi	Përshkrimi	Cmimi
4200993	Wilo-Pompe Helix First V 1606-5/16/E/S/4KW	-

Panele Diellore

Ngrohje & Ftohje

Hidraulike

Hidrosanitare

Aksesore të ndryshëm



Pompe zhytесе, Pompe wc-je, Pompe dranzhi shatervani

Wilo-Pompe Zhytесе



Kodi	Përshkrimi	Cmimi
6083324	Wilo-Pompe zhytесе FIRST SPU4.02-10-B/X14-50-1-230 ,550 wat	-

Wilo-Pompe Zhytесе



Kodi	Përshkrimi	Cmimi
6083335	Wilo-Pompe zhytесе FIRST SPU4.04-09-B/X14-50-1-230 ,750 wat	-

Wilo-Pompe Zhytесе



Kodi	Përshkrimi	Cmimi
6083336	Wilo-Pompe zhytесе FIRST SPU4.04-14-B/X14-50-1-230 ,1.1 kw	-

Wilo-Pompe Zhytесе



Kodi	Përshkrimi	Cmimi
6083337	Wilo-Pompe zhytесе FIRST SPU4.04-18-B/X14-50-1-230 ,1.5 kw	-

Wilo-Pompe Zhytесе



Kodi	Përshkrimi	Cmimi
6083351	Wilo-Pompe zhytесе FIRST SPU4.08-08-B/X14-50-1-230 ,1.5 kw	-

Wilo-Pompe Zhytесе



Kodi	Përshkrimi	Cmimi
6083338	Wilo-Pompe zhytесе FIRST SPU4.04-27-B/X14-50-1-230 ,2.2 kw	-

Wilo-Pompe Zhytесе



Kodi	Përshkrimi	Cmimi
2952241	Wilo-Pompe zhytесе FIRST SPU4.01-14-C/X14-50-1-230 , fi 1.1/4-1547H	-

Wilo-Pompe WC-JE



Kodi	Përshkrimi	Cmimi
HiSewlift3	Wilo-Pompe per kaset wc-je	-

Wilo-Pompe dranzhi shatervani



Kodi	Përshkrimi	Cmimi
6043945	Wilo-Pompe dranzhi&shatervani TS 32/12A	-

Panele Diellore

Ngrohje & Ftohje

Hidraulike

Hidrosanitare

Aksesore të ndryshëm



Pompe dranazhi shatervani, Ene zgjerimi

Wilo-Pompe dranazhi shatervani



Kodi	Përshkrimi	Cmimi
4186548	Wilo-Pompe dranazhi&shatervani INITIAL DRAIN 13-9	-

Wilo-Pompe dranazhi



Kodi	Përshkrimi	Cmimi
MTC 40	Wilo-Pompe dranazhi MTC40 F16 15/7/1-230-50-MF	-

Wilo-Ene zgjerimi



Kodi	Përshkrimi	Cmimi
2950899	Wilo-Ene zgjerimi 35 lt, 10 bar ngrohje/ftohje	-

Wilo-Ene zgjerimi



Kodi	Përshkrimi	Cmimi
2950903	Wilo-Ene zgjerimi 100 lt, 10 bar ngrohje/ftohje	-

Wilo-Pompe dranazhi shatervani



Kodi	Përshkrimi	Cmimi
4145325	Wilo-Pompe dranazhi&shatervani TMR 32/8	-

Wilo-Ene zgjerimi



Kodi	Përshkrimi	Cmimi
2950898	Wilo-Ene zgjerimi 24 lt, 10 bar ngrohje/ftohje	-

Wilo-Ene zgjerimi



Kodi	Përshkrimi	Cmimi
2950900	Wilo-Ene zgjerimi 50 lt, 10 bar ngrohje/ftohje	-

Wilo-Ene zgjerimi



Kodi	Përshkrimi	Cmimi
2950904	Wilo-Ene zgjerimi 150 lt, 10 bar ngrohje/ftohje	-

Wilo-Pompe dranazhi shatervani



Kodi	Përshkrimi	Cmimi
4048414	Wilo-Pompe dranazhi&shatervani TMW 32/11	-

Wilo-Ene zgjerimi



Kodi	Përshkrimi	Cmimi
2950890	Wilo-Ene zgjerimi 24 lt, 10 bar ngrohje/ftohje	-

Wilo-Ene zgjerimi



Kodi	Përshkrimi	Cmimi
2950902	Wilo-Ene zgjerimi 80 lt, 10 bar ngrohje/ftohje	-

Wilo-Ene zgjerimi



Kodi	Përshkrimi	Cmimi
2950905	Wilo-Ene zgjerimi 200 lt, 10 bar ngrohje/ftohje	-

Panele Diellore

Ngrohje & Ftohje

Hidraulike

Hidrosanitare

Aksesore të ndryshëm



Ene zgjerimi, Aksesor

Wilo-Ene zgjerimi



Wilo-Ene zgjerimi



Wilo-Aksesor



Kodi	Përshkrimi	Cmimi
2950906	Wilo-Ene zgjerimi 300 lt,10 bar ngrohje/ftohje	-

Kodi	Përshkrimi	Cmimi
2950907	Wilo-Ene zgjerimi 500 lt,10 bar ngrohje/ftohje	-

Kodi	Përshkrimi	Cmimi
2950074	Wilo-Hollandez Pompe 1"x1.1/2(Top-S 25/5, 25/7)	-

Wilo-Aksesor



Wilo-Aksesor



Wilo-Aksesor



Kodi	Përshkrimi	Cmimi
2950075	Wilo-Hollandez Pompe 2"x1.1/4(Star-Rs 30/6)	-

Kodi	Përshkrimi	Cmimi
4241253	Wilo-Guide vane Jetson WJ202/203 VP	-

Kodi	Përshkrimi	Cmimi
64873	Wilo-Electrode -PMS	-

Panele Diellore

Ngrohje & Ftohje

Hidraulike

Hidrosanitare

Aksesore të ndryshëm



Paketa elektronike

Ecofer – Kit per bolier



Kodi	Përshkrimi	Cmimi
ECOF005	Kit per bolier-Smart Sol inverter 13 lt/min	-

Ecofer – Kit per bolier



Kodi	Përshkrimi	Cmimi
ECOF018	Kit per bolier-Smart Sol inverter 4-36 lt/min	-

Ecofer – Pakete elektronike bolieri



Kodi	Përshkrimi	Cmimi
ECOF009	Pakete elektronike bolieri EMZ-Nano Basic-3 sensore (1G) (Z nga 1-2)	-

Ecofer – Pakete elektronike bolieri



Kodi	Përshkrimi	Cmimi
ECOF010	Pakete elektronike bolieri EMZ-Smart Sol Comfort - 4 sensore (1G) (Z nga 1-3)	-

Ecofer – Pakete elektronike bolieri



Kodi	Përshkrimi	Cmimi
ECOF017	Pakete elektronike bolieri EMZ-Smart Smart Nano Special -3 sensore (1G) (Z nga 1-2)	-

Ecofer – Kalinmates uji



Kodi	Përshkrimi	Cmimi
ECOF013	Kalinmates uji Ø ¾ per kit bolier smart sol	-

Ecofer – Pakete elektronike bolieri



Kodi	Përshkrimi	Cmimi
ECOF015	Pakete elektronike bolieri -Smart box wi-fi	-

Ecofer – Saracineske elektrike



Kodi	Përshkrimi	Cmimi
ECOF014	Saracineske elektrike 3 rrugshe Ø 1.1/4 per kit smart sol	-

Ecofer – Sonde per pakete



Kodi	Përshkrimi	Cmimi
ECOF016	Sonde per pakete elektronike e zeze	-

Panele Djellore

Ngrohje & Ftohje

Hidraulike

Hidrosanitare

Aksesore të ndryshëm



Mbledhes lageshtie, Kondicioner Pinguin

Ecofer – Mbledhes lageshtie



Ecofer – Mbledhes lageshtie



Ecofer – Mbledhes lageshtie



Kodi	Përshkrimi	Cmimi
ECOF019	Mbledhes lageshtie 11 Lt Easy	-

Kodi	Përshkrimi	Cmimi
ECOF020	Mbledhes lageshtie 13 Lt Fast	-

Kodi	Përshkrimi	Cmimi
ECOF021	Mbledhes lageshtie 17 Lt Comfort	-

Ecofer – Mbledhes lageshtie



Ecofer – Kondicioner Pinguin



Kodi	Përshkrimi	Cmimi
ECOF022	Mbledhes lageshtie 21 Lt Fine	-

Kodi	Përshkrimi	Cmimi
ECOF023	Kondicioner pinguin 13000 btu	-

Panele Diellore

Ngrahje & Ftohje

Hidraulike

Hidrosanitare

Aksesore të ndryshëm

Pakete elektrike

Elentek-Pakete elektrike



Kodi	Përshkrimi	Cmimi
1015	Pakete elektrike komanduese per pompe teke-Smart Evo 1-MF 2.2KW	-

Elentek-Pakete elektrike



Kodi	Përshkrimi	Cmimi
1017	Pakete elektrike komanduese per pompe teke-Smart Evo 1-3F 11KW	-

Elentek-Pakete elektrike



Kodi	Përshkrimi	Cmimi
2015	Pakete elektrike komanduese per pompe Binjake-Smart Evo 2 - MF 2.2KW	-

Elentek-Pakete elektrike



Kodi	Përshkrimi	Cmimi
2016	Pakete elektrike komanduese per pompe binjake-Smart Evo 2-3F 7.5KW	-

Elentek-Pakete elektrike



Kodi	Përshkrimi	Cmimi
2017	Pakete elektrike komanduese per pompe binjake-Smart Evo 2-3F 11KW	-

Elentek-Pakete elektrike



Kodi	Përshkrimi	Cmimi
97526	Pakete elektrike Smart Evo 2 7.5KW	-

Elentek-Pakete elektrike



Kodi	Përshkrimi	Cmimi
1160	Pakete elektrike per pompe binjake Minivar TT230/2.2-inverter	-

Elentek-Pakete elektrike



Kodi	Përshkrimi	Cmimi
1166	Pakete elektrike per pompe binjake Minivar TT400/2.2-inverter	-

Elentek-Manometer



Kodi	Përshkrimi	Cmimi
99056	Manometer per pompe 0-10 bar	-

Panele Djellore

Ngrohje & Ftohje

Hidraulike

Hidrosanitare

Aksesore të ndryshëm

elentek® Presostat, Galixhan, Bazament, Kolektor

Elentek-Presostat elektrike



Kodi	Përshkrimi	Cmimi
99051	Presostat elektrik per pompe 3-12 bar	-

Elentek-Presostat elektrike



Kodi	Përshkrimi	Cmimi
99050	Presostat elektrik per pompe 1-5 bar	-

Elentek-Galixhan elektrike



Kodi	Përshkrimi	Cmimi
99033	Galixhan elektrik 5m	-

Elentek-Bazament metalik



Kodi	Përshkrimi	Cmimi
99009	Bazament metalik pompe 550x30mm	-

Elentek-Kolektor pompe

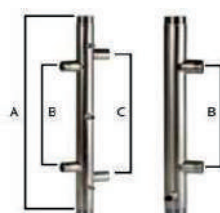

Kodi	Përshkrimi	Cmimi
99010	Kolektor 50 cm 1.1/2"x1"x3/8 (150/100)	-

Elentek-Kolektor pompe

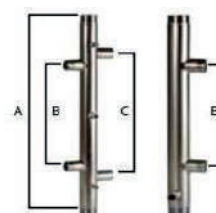

Kodi	Përshkrimi	Cmimi
99015	Kolektor o 50 cm 1.1/2"x1"x1/2 (150/100)	-

Elentek-Kolektor pompe

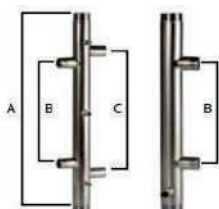

Kodi	Përshkrimi	Cmimi
99011	Kolektor 50 cm 2"x1.1/4"x1/4 (200/125)	-

Elentek-Kolektor pompe

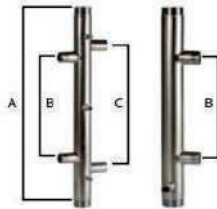

Kodi	Përshkrimi	Cmimi
99016	Kolektor 50 cm 2"x1.1/4"x1/2 (200/125)	-

Elentek-Kolektor pompe

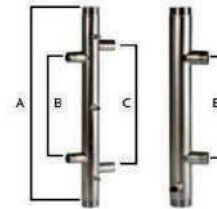

Kodi	Përshkrimi	Cmimi
99021	Kolektor 60 cm 2"x1.1/4"x3/8 (200/125)	-

Elentek-Kolektor pompe

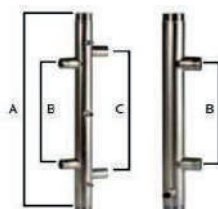

Kodi	Përshkrimi	Cmimi
99024	Kolektor 60 cm 2"x1.1/4"x1/2 (200/125)	-

Panelle Dielllore

Ngrohje & Ftohje

Hidraulike

Hidrosanitare

Aksesore të ndryshëm



HT PLUS INDOOR LOW-NOISE SEWAGE SYSTEM



ULTRA dB SOUNDPROOF SEWAGE SYSTEM



SKOLAN dB THICK-WALLED SOUNDPROOF SEWAGE SYSTEM



KG OUTDOOR SEWAGE SYSTEM



MAGNACOR OUTDOOR SEWAGE SYSTEM



PP KG 2000 SN 10 OUTDOOR SEWAGE SYSTEM



SC MANHOLES



PE POLYETHYLENE SYSTEMS



DR DRAINAGE SYSTEMS

SIENIAWA ŻARSKA 69, 68-213 LIPINKI ŁUŻYCKIE
POLAND

PHONE: +48 68 363 27 00

FAX: +48 68 363 27 72

WWW.MAGNAPLAST.PL

Tub PP

Magnaplast-Tub PP



Magnaplast-Tub PP



Magnaplast-Tub PP



Kodi	Përshkrimi	Cmimi
408116	Ø32/0.15 (1man)	-
408216	Ø32/0.25 (1man)	-
408316	Ø32/0.315 (1man)	-
408416	Ø32/0.50 (1man)	-
408616	Ø32/1 (1man)	-
408716	Ø32/1.5 (1man)	-
408816	Ø32/2 (1man)	-
408916	Ø32/3 (1man)	-
10100	Ø40/0.15 (1man)	-
10110	Ø40/0.25 (1man)	-
10115	Ø40/0.315 (1man)	-
10120	Ø40/0.5 (1man)	-
10140	Ø40/1 (1man)	-
10150	Ø40/1.5 (1man)	-
10160	Ø40/2 (1man)	-
10200	Ø50/0.15 (1man)	-
10210	Ø50/0.25 (1man)	-
10215	Ø50/0.315 (1man)	-
10220	Ø50/0.5 (1man)	-

Kodi	Përshkrimi	Cmimi
10230	Ø50/0.75 (1man)	-
10240	Ø50/1 (1man)	-
10250	Ø50/1.5 (1man)	-
10260	Ø50/2 (1man)	-
10265	Ø50/3 (1man)	-
10300	Ø75/0.15 (1man)	-
10310	Ø75/0.25 (1man)	-
10315	Ø75/0.315 (1man)	-
10320	Ø75/0.5 (1man)	-
10330	Ø75/0.75 (1man)	-
10340	Ø75/1 (1man)	-
10341	Ø75/2,3/1 (1man)	-
10350	Ø75/1.5 (1man)	-
10360	Ø75/2 (1man)	-
10361	Ø75/2,3/2 (1man)	-
10365	Ø75/3 (1man)	-
10366	Ø75/2,3/3 (1man)	-
10400	Ø110/0.15 (1man)	-
10410	Ø110/0.25 (1man)	-

Kodi	Përshkrimi	Cmimi
10415	Ø110/0.315 (1man)	-
10420	Ø110/0.5 (1man)	-
10430	Ø110/0.75 (1man)	-
10440	Ø110/1 (1man)	-
10441	Ø110/3,4/1 (1man)	-
10450	Ø110/1.5 (1man)	-
10460	Ø110/2 (1man)	-
10461	Ø110/3,4/2 (1man)	-
10465	Ø110/3 (1man)	-
10466	Ø110/3m4/3 (1man)	-
10510	Ø125/0.25 (1man)	-
10520	Ø125/0.5 (1man)	-
10540	Ø125/1 (1man)	-
10560	Ø125/2 (1man)	-
10620	Ø160/0.5 (1man)	-
10640	Ø160/1 (1man)	-
10650	Ø160/1.5 (1man)	-
10660	Ø160/2 (1man)	-
10665	Ø160/3 (1man)	-

Panele Dielllore

Ngrohje & Ftohje

Hidraulike

Hidrosanitare

Aksesore të ndryshëm

Magnoplast-Brryl PP



Kodi	Përshkrimi	Cmimi
421008	Ø32/15	-
421108	Ø32/30	-
421208	Ø32/45	-
421209	Ø32/67	-
421308	Ø32/88.5	-
10700	Ø40/15	-
10710	Ø40/30	-
10720	Ø40/45	-
10730	Ø40/67	-
10750	Ø40/87	-
10800	Ø50/15	-
10804	Ø50/22.5	-

Magnoplast-Brryl PP



Kodi	Përshkrimi	Cmimi
10810	Ø50/30	-
10820	Ø50/45	-
10830	Ø50/67	-
10850	Ø50/87	-
10900	Ø75/15	-
10910	Ø75/30	-
10920	Ø75/45	-
10930	Ø75/67	-
10950	Ø75/87	-
11000	Ø110/15	-
11004	Ø110/22.5	-
11010	Ø110/30	-

Magnoplast-Brryl PP



Kodi	Përshkrimi	Cmimi
11020	Ø110/45	-
11030	Ø110/67	-
11050	Ø110/87	-
11100	Ø125/15	-
11110	Ø125/30	-
11120	Ø125/45	-
11130	Ø125/67	-
11150	Ø125/87	-
11200	Ø160/15	-
11210	Ø160/30	-
11220	Ø160/45	-
11250	Ø160/87	-

Magnoplast-Ypsilon PP



Kodi	Përshkrimi	Cmimi
11400	Ø50x50/50	-
11410	Ø75x75/75	-
11420	Ø110x50/50	-
11440	Ø110x110/110	-

Magnoplast-Ypsilon kendore PP



Kodi	Përshkrimi	Cmimi
11450	Ø110/110/110	-

Magnoplast-Tapa PP



Kodi	Përshkrimi	Cmimi
425008	Ø32	-
12500	Ø40	-
12510	Ø50	-
12520	Ø75	-
12530	Ø110	-
12540	Ø125	-
12550	Ø160	-

Magnaplast-Ypsilon PP



Kodi	Përshkrimi	Cmimi
422103	Ø32/32/45	-
11500	Ø40/40/45	-
11510	Ø50/40/45	-
11520	Ø50/50/45	-
11540	Ø75/50/45	-
11550	Ø75/75/45	-
11560	Ø110/50/45	-
11570	Ø110/75/45	-
11580	Ø110/110/45	-
11590	Ø125/110/45	-
11600	Ø125/125/45	-
11610	Ø160/110/45	-
11630	Ø160/160/45	-

Magnaplast-Ypsilon PP



Kodi	Përshkrimi	Cmimi
11700	Ø40/40/67	-
11710	Ø50/40/67	-
11720	Ø50/50/67	-
11740	Ø75/50/67	-
11750	Ø75/75/67	-
11760	Ø110/50/67	-
11770	Ø110/75/67	-
11780	Ø110/110/67	-

Magnaplast-Ypsilon PP



Kodi	Përshkrimi	Cmimi
422608	Ø32/32/88.5	-
11900	Ø40/40/87	-
11910	Ø50/40/87	-
11920	Ø50/50/87	-
11940	Ø75/50/87	-
11950	Ø75/75/87	-
11960	Ø110/50/87	-
11970	Ø110/75/87	-
11980	Ø110/110/87	-
11990	Ø125/110/87	-
12000	Ø125/125/87	-
12010	Ø160/110/87	-
12030	Ø160/160/87	-

Magnaplast-Reduksion PP



Kodi	Përshkrimi	Cmimi
11325	Ø75/50 shkurter	-
11335	Ø110/50 shkurter	-
11345	Ø110/75 shkurter	-
11385	Ø160/110 shkurter	-

Magnaplast-Reduksion PP



Kodi	Përshkrimi	Cmimi
420413	Ø50/32 shkurter	-
420410	Ø40/32 gjate	-
420412	Ø50/32 gjate	-

Magnaplast-Reduksion PP



Kodi	Përshkrimi	Cmimi
11300	Ø50/40 gjate	-
11320	Ø75/50 gjate	-
11330	Ø110/50 gjate	-
11340	Ø110/75 gjate	-
11350	Ø125/110 gjate	-
11360	Ø160/110 gjate	-
11370	Ø160/125 gjate	-

Magnoplast- Manikota PP



Kodi	Përshkrimi	Cmimi
420108	ø32	-
12100	ø40	-
12110	ø50	-
12120	ø75	-
12130	ø110	-
12140	ø125	-
12150	ø160	-

Magnoplast- Manikota PP



Kodi	12260Përshkrimi	Cmimi
420208	ø32	-
12200	ø40	-
12210	ø50	-
12220	ø75	-
12230	ø110	-
12240	ø125	-
12250	ø160	-

Magnoplast- Ti tape kontrolli PP



Kodi	12260Përshkrimi	Cmimi
12410	ø50	-
12420	ø75	-
12430	ø110	-
12440	ø125	-
12450	ø160	-

Magnoplast-Brryl Pvc PP



Kodi	Përshkrimi	Cmimi
12840	ø50/30	-
12850	ø40/30	-
12860	ø40/40	-
12870	ø50/40	-
12880	ø50/50	-

Magnoplast- Reduksion Pvc PP



Kodi	12260Përshkrimi	Cmimi
12800	ø40/40	-
12810	ø50/40	-
12820	ø50/50	-

Magnoplast- Reduksion Pvc PP



Kodi	12260Përshkrimi	Cmimi
12610	ø50	-
12620	ø75	-
12630	ø110	-

Magnoplast- Ti me gomin PP



Kodi	12260Përshkrimi	Cmimi
14101	ø110/110/87	-

Magnoplast- Brryl I reduktuar PP



Kodi	12260Përshkrimi	Cmimi
421412	ø32/50	-

Magnoplast- Manikot ne gomine PP



Kodi	12260Përshkrimi	Cmimi
12735	ø100/100	-

Magnoplast-Manikota PP



Kodi	Përshkrimi	Cmimi
12300	Ø40 e gjate	-
12310	Ø50 e gjate	-
12320	Ø75 e gjate	-
12330	Ø110 e gjate	-

Magnoplast-Gomina PP



Kodi	Përshkrimi	Cmimi
12900	Ø40/30 A	-
12910	Ø40/30 B	-
12920	Ø40/40 C	-
12930	Ø50/30 D	-
12940	Ø50/40 E	-
12950	Ø50/50 F	-

Magnoplast-Kapele PP



Kodi	Përshkrimi	Cmimi
13210	Ø50 gri	-
13220	Ø75 gri	-
13230	Ø110 gri	-

Magnoplast- Kapele ajrimi PP



Kodi	12260Përshkrimi	Cmimi
13410	Ø50	-
13420	Ø75	-
13430	Ø110	-

Magnoplast- Fasheta PP



Kodi	12260Përshkrimi	Cmimi
13515	Ø50	-
13525	Ø75	-
13535	Ø110	-
13555	Ø160	-

Magnoplast-Fasheta PP



Kodi	Përshkrimi	Cmimi
13590	Ø32	-
13500	Ø40	-
13510	Ø50	-
13520	Ø75	-
13530	Ø100	-

Magnoplast- Brryl me dy dalje PP



Kodi	12260Përshkrimi	Cmimi
12890	Ø40/50/40	-

Magnoplast-Lubrifikant



Kodi	Përshkrimi	Cmimi
13110	250ml	-
13120	500ml	-

Magnaplast-Tub PP



Magnaplast-Tub PP



Magnaplast-Tub PP



Kodi	Përshkrimi	Cmimi
146010	Ø50/0.25 (1man)	-
146015	Ø50/0.315 (1man)	-
146020	Ø50/0.5 (1man)	-
146040	Ø50/1 (1man)	-
146060	Ø50/2 (1man)	-
146065	Ø50/3 (1man)	-
146110	Ø75/0.25 (1man)	-
146115	Ø75/0.315 (1man)	-
146120	Ø75/0.5 (1man)	-

Kodi	Përshkrimi	Cmimi
146140	Ø75/1 (1man)	-
14660	Ø75/2 (1man)	-
146165	Ø75/3 (1man)	-
146210	Ø110/0.25 (1man)	-
146215	Ø110/0.315 (1man)	-
146220	Ø110/0.5 (1man)	-
146240	Ø110/1 (1man)	-
146260	Ø110/2 (1man)	-
146265	Ø110/3 (1man)	-

Kodi	Përshkrimi	Cmimi
146222	Ø125/0.5 (1man)	-
146242	Ø125/1 (1man)	-
146262	Ø125/2 (1man)	-
146270	Ø160/0.5 (1man)	-
146180	Ø160/1 (1man)	-
146290	Ø160/2 (1man)	-
146295	Ø160/3 (1man)	-

Magnaplast-Brryl PP



Magnaplast-Brryl PP



Magnaplast-Brryl PP



Kodi	Përshkrimi	Cmimi
146300	Ø50/15	-
146310	Ø50/30	-
146320	Ø50/45	-
146325	Ø50/67	-
146330	Ø50/87	-
146340	Ø75/15	-
146350	Ø75/30	-

Kodi	Përshkrimi	Cmimi
146360	Ø75/45	-
146365	Ø75/67	-
146370	Ø75/87	-
146420	Ø110/15	-
146430	Ø110/30	-
146440	Ø110/45	-
146445	Ø110/67	-

Kodi	Përshkrimi	Cmimi
146450	Ø110/87	-
146442	Ø125/45	-
146452	Ø125/87	-
146453	Ø160/45	-
146457	Ø160/87	-

Magnoplast-Ypsilon PP



Kodi	Përshkrimi	Cmimi
146560	∅50x50x45°	-
146540	∅75x50x45°	-
146520	∅75x75x45°	-
146500	∅110x50x45°	-
146480	∅110x75x45°	-
146460	∅110x110x45°	-
146462	∅125x110x45°	-

Magnoplast-Ypsilon PP



Kodi	Përshkrimi	Cmimi
146467	∅125x125x45°	-
146485	∅160x110x45°	-
146465	∅160x160x45°	-
146585	∅110x50x67°	-
146590	∅110x75x67°	-
146595	∅110x110x67°	-
146570	∅50x50x87°	-

Magnoplast-Ypsilon PP



Kodi	Përshkrimi	Cmimi
146550	∅75x50x87°	-
146530	∅75x75x87°	-
146510	∅110x50x87°	-
146490	∅110x75x87°	-
146470	∅110x110x87°	-
146475	∅160x160x87°	-

Magnoplast-Reduksion PP



Kodi	Përshkrimi	Cmimi
146600	∅75/50 gjate	-
146610	∅110/50 gjate	-
146620	∅110/75 gjate	-
146622	∅125/110 gjate	-
146625	∅160/110 gjate	-
146627	∅160/125 gjate	-

Magnoplast-Tapa kontrolli PP



Kodi	Përshkrimi	Cmimi
146710	∅50	-
146720	∅75	-
146730	∅110	-
146732	∅125	-

Magnoplast- Manikota PP



Kodi	Përshkrimi	Cmimi
146680	∅50	-
146690	∅75	-
146700	∅110	-
14708	∅160	-

Magnoplast- Manikota PP



Kodi	Përshkrimi	Cmimi
146650	∅50	-
146660	∅75	-
146670	∅110	-
146675	∅160	-

Magnoplast- Ti tape kontrolli PP



Kodi	Përshkrimi	Cmimi
146750	∅110	-
146752	∅125	-
146755	∅160	-

magnoplast Ypsilon PP

Magnaplast-Ypsilon PP



Kodi	Përshkrimi	Cmimi
146900	Ø110x110/67	-

Magnaplast-Ypsilon kendore PP



Kodi	Përshkrimi	Cmimi
146920	Ø110/110/67	-

Panele Diellore

Ngrohje & Ftohje

Hidraulike

Hidrosanitare

Aksesore të ndryshëm

Panele Dielllore

Ngrohje & Ftohje

Hidraulike

Hidrosanitare

Aksesorë të ndryshëm

Tub PP Faso , fi 100



Tub PP Faso , fi 100



Tub PP Faso , fi 100



Kodi	Përmasat	Cmimi
FASO219	fi 100/0.15 (1 Man.)	-
FASO220	fi 100/0.25 (1 Man.)- 1101000250	-
FASO221	fi 100/0.50 (1 Man.)- 1101000500	-
FASO222	fi 100/0.75 (1 Man.)- (1101000750)	-
FASO223	fi 100/1.00 (1 Man.)- 1101001000	-
FASO224	fi 100/1.50 (1 Man.)- (1101001500)	-
FASO226	fi 100/2.00 (1 Man.)- 1101002000	-
FASO228	fi 100/3.00 (1 Man.) - 1101003000	-

Kodi	Përmasat	Cmimi
FASO403	fi 100/1.00 (2 man) (1201001000)	-
FASO225	fi 100/1.50 (2 man) (1101001500)	-
FASO227	fi 100/2.00 (2 man)- 1201002000	-
FASO229	fi 100/3.00 (2 man)- 1201003000	-

Kodi	Përmasat	Cmimi
FASO418	fi 100/3 (1 Man.)Triplex- (1131003000)	-
FASO021	fi 100/1.5 (2 Man.)Triplex- (12310015000)	-

Brryl PP Faso , fi 100



Brryl PP Faso , fi 100



Brryl PP Faso , fi 100



Kodi	Përmasat	Cmimi
FASO021	fi 100x15° (1301001500)	-

Kodi	Përmasat	Cmimi
FASO022	fi 100x30° (1301003000)	-

Kodi	Përmasat	Cmimi
FASO023	fi 100x45° (1301004500)	-

Brryl PP Faso , fi 100



Brryl PP Faso , fi 100



Ypsilon PP Faso , fi 100



Kodi	Përmasat	Cmimi
FASO024	fi 100x67° (1301006730)	-

Kodi	Përmasat	Cmimi
FASO025	fi 100x87° (1301008730)	-

Kodi	Përmasat	Cmimi
FASO340	fi 100x45°-(1410010045)	-

Ypsilon PP Faso , fi 100



Kodi	Përmasat	Cmimi
FASO344	fi 100x75/45° -(1510007567)	-
FASO380	fi 100x50/45-(1510005045)	-

Ypsilon PP Faso , fi 100



Kodi	Përmasat	Cmimi
FASO343	fi 100x67° -(1410010067)	-

Ypsilon PP Faso , fi 100



Kodi	Përmasat	Cmimi
FASO341	fi 100x50/67°	-
FASO345	fi 100x75/67°	-

Ti PP Faso , fi 100



Kodi	Përmasat	Cmimi
FASO175	fi 100x87° (1410010087)	-
FASO173	fi 100x50x87° (1510005087)	-
FASO174	fi 100x75x87° (1510007587)	-

Ti Tape Kontrolli PP Faso ,fi 100



Kodi	Përmasat	Cmimi
FASO209	fi 100	-

Reduksion PP Faso ,fi 100



Kodi	Përmasat	Cmimi
FASO111	fi 100/50 i shkurter (1704050100)	-
FASO112	fi 100/75 i shkurter (1704075100)	-

Manikota PP Faso , fi 100



Kodi	Përmasat	Cmimi
FASO412	fi 100 (1801000100)	-

Manikota PP Faso , fi 100



Kodi	Përmasat	Cmimi
FASO082	fi 100 (8071100100)	-

Tape Kontrolli PP Faso , fi 100



Kodi	Përmasat	Cmimi
FASO151	fi 100 (1804000100)	-

Tub PP-R , PN20



Tub PP-R , PN20 100



Tub PP-R , PN20 Aluminium



Kodi	Përmasat	Sasia	Cmimi
10000230	Ø20x3,4/4000	25	-
10000240	Ø25x4,2/4000	20	-
10000250	Ø32x5,4/4000	14	-
10000260	Ø40x6,7/4000	10	-
10000270	Ø50x8,3/4000	8	-
10000280	Ø63x10,5/400	5	-
10000290	Ø75x12,5/400	3	-

Kodi	Përmasat	Sasia	Cmimi
10000232	Ø20x3,4/4000	25	-
10000242	Ø25x4,2/4000	20	-
10000252	Ø32x5,4/4000	14	-
10000262	Ø40x6,7/4000	10	-
10000272	Ø50x8,3/4000	8	-
10000282	Ø63x10,5/400	5	-

Kodi	Përmasat	Sasia	Cmimi
10000540	Ø20x3,4/4000	25	-
10000550	Ø25x4,2/4000	20	-
10000560	Ø32x5,4/4000	14	-
10000570	Ø40x6,7/4000	10	-
10000580	Ø50x8,3/4000	8	-
10000590	Ø63x10,5/400	5	-

Tub Fiberglas , SDR 7.4 , PN20



Tub Fiberglas , SDR 6 , PN20



Kodi	Përmasat	Sasia	Cmimi
10000700	Ø20x/4000	25	-
10000701	Ø25x/4000	20	-
10000702	Ø32x/4000	14	-
10000703	Ø40x/4000	10	-
10000704	Ø50x/4000	8	-
10000705	Ø63x/4000	5	-
10000706	Ø75x/4000	3	-
10000707	Ø90x/4000	2	-

Kodi	Përmasat	Sasia	Cmimi
10000820	Ø20x/4000	25	-
10000821	Ø25x/4000	20	-
10000822	Ø32x/4000	14	-
10000823	Ø40x/4000	10	-
10000824	Ø50x/4000	8	-
10000825	Ø63x/4000	5	-

Brryl PP-R

Kodi	Përmasat	Sasia	Cmimi
10001000	∅20/45°	30	-
10001001	∅25/45°	25	-
10001002	∅32/45°	20	-
10001003	∅40/45°	10	-
10001004	∅50/45°	6	-

Brryl PP-R

Kodi	Përmasat	Sasia	Cmimi
10001020	∅20/90°	30	-
10001021	∅25/90°	25	-
10001022	∅32/90°	20	-
10001023	∅40/90°	10	-
10001024	∅50/90°	6	-
10001025	∅63/90°	4	-
10001026	∅75/90°	1	-
10001027	∅90/90°	1	-
10001028	∅110/90°	1	-

Brryl me tre drejtme

Kodi	Përmasat	Sasia	Cmimi
10001050	∅20/90°	10	-
10001051	∅25/90°	10	-

Brryl i ngurtë

Kodi	Përmasat	Sasia	Cmimi
10001070	∅20/90°	5	-

Brryl me fileto femër

Kodi	Përmasat	Sasia	Cmimi
10001100	∅20x1/2" 90°	10	-
10001101	∅25x3/4" 90°	10	-
10001102	∅32x1" 90°	10	-
10001450	∅20x3/4"	10	-
10001451	∅25x1/2"	10	-

Brryl me fileto mashkull

Kodi	Përmasat	Sasia	Cmimi
10001150	∅20x1/2" 90°	10	-
10001151	∅25x3/4" 90°	10	-
10001152	∅32x1" 90°	10	-
10001500	∅20x3/4"	10	-
10001501	∅25x1/2"	10	-

Brryl 90°-femër me fileto të dyfishtë

Kodi	Përmasat	Sasia	Cmimi
10001200	∅20x1/2"	10	-

Brryl 90° - me fileto mashkull

Kodi	Përmasat	Sasia	Cmimi
10001250	∅20x1/2"	10	-
10001251	∅20x3/4"	10	-

Mbajtëse fikse për brryl



Kodi	Përmasat	Sasia	Cmimi
10001300	-	10	-

Maskë brryli me kllapa fikse



Kodi	Ngjyra	Sasia	Cmimi
10001350	E bardhe	10	-
10001351	Jeshile	10	-

Brryl 90° - i reduktuar



Kodi	Përmasat	Sasia	Cmimi
10001400	Ø20/Ø25	10	-

Brryl 90° - mashkull-femer



Kodi	Përmasat	Sasia	Cmimi
10001550	Ø20	10	-

Brryl 90° - mashkull-femër-femër



Kodi	Përmasat	Sasia	Cmimi
10001551	Ø20X1/2"	10	-

Brryl 90° - mashkull-femër-mashkull



Kodi	Përmasat	Sasia	Cmimi
10001552	Ø20X1/2"	10	-

Manikote



Kodi	Përmasat	Sasia	Cmimi
10001600	Ø16x	-	-
10001601	Ø20x	30	-
10001602	Ø25x	25	-
10001603	Ø32x	20	-
10001604	Ø40x	10	-
10001605	Ø50x	6	-
10001606	Ø63x	4	-
10001607	Ø75x	2	-
10001608	Ø90x	1	-
10001609	Ø110x	1	-

Xhunto PP-R



Kodi	Përmasat	Sasia	Cmimi
10001651	Ø20X1/2"	10	-
10001652	Ø25X3/4"	10	-
10001653	Ø32X1"	10	-
10001654	Ø40X5/4"	6	-
10001655	Ø50X6/4"	4	-
10001656	Ø63X2"	4	-

Xhunto PP-R



Kodi	Përmasat	Sasia	Cmimi
10001701	Ø20X1/2"	10	-
10001702	Ø25X3/4"	10	-
10001703	Ø32X1"	10	-
10001704	Ø40X5/4"	6	-
10001705	Ø50X6/4"	4	-
10001706	Ø63X2"	4	-

Xhunto PP-R



Kodi	Përmasat	Sasia	Cmimi
10001800	Ø20X3/4"	10	-
10001801	Ø25X1/2"	10	-

Xhunto PP-R



Kodi	Përmasat	Sasia	Cmimi
10001850	Ø20X3/4"	10	-
10001851	Ø25X1/2"	10	-

TI PP-R



Kodi	Përmasat	Sasia	Cmimi
10001900	Ø20	30	-
10001901	Ø25	25	-

TI PP-R



Kodi	Përmasat	Sasia	Cmimi
10001902	Ø32	20	-
10001903	Ø40	10	-
10001904	Ø50	6	-
10001905	Ø63	4	-

TI PP-R



Kodi	Përmasat	Sasia	Cmimi
10001906	Ø75	1	-
10001907	Ø90	1	-
10001908	Ø110	1	-

TI PP-R



Kodi	Përmasat	Sasia	Cmimi
10002090	Ø20X3/4" F	10	-
10002091	Ø25X1/2" F	10	-

TI PP-R



Kodi	Përmasat	Sasia	Cmimi
10002100	Ø20X1/2" M	10	-
10002101	Ø25X1/2" M	10	-

TI kryq



Kodi	Përmasat	Sasia	Cmimi
10002150	Ø20	10	-
10002151	Ø25	10	-
10002152	Ø32	10	-

Reduksion PP-R



Kodi	Përmasat	Sasia	Cmimi
10002200	Ø25/Ø20	30	-
10002205	Ø32/Ø20	25	-
10002206	Ø32/Ø25	20	-

Reduksion PP-R



Kodi	Përmasat	Sasia	Cmimi
10002212	Ø40/Ø32	6	-
10002222	Ø50/Ø32	6	-
10002223	Ø50/Ø40	10	-
10002240	Ø63/Ø20	10	-
10002241	Ø63/Ø25	10	-

Reduksion PP-R



Kodi	Përmasat	Sasia	Cmimi
10002242	Ø63/Ø32	10	-
10002242	Ø63/Ø40	10	-
10002244	Ø63/Ø50	4	-
10002262	Ø75/Ø63	2	-
10002282	Ø90/Ø75	2	-

Reduksion PP-R



Kodi	Përmasat	Sasia	Cmimi
10002300	Ø25/Ø20	30	-
10002301	Ø32/Ø20	25	-
10002302	Ø32/Ø25	20	-
10002303	Ø40/Ø20	10	-
10002304	Ø40/Ø25	10	-

Trupi i valvulës



Kodi	Përmasat	Sasia	Cmimi
10002350	Ø20	10	-
10002351	Ø25	10	-
10002352	Ø32	10	-

Tapë fundore PP-R



Kodi	Përmasat	Sasia	Cmimi
10002400	Ø20	30	-
10002401	Ø25	25	-
10002402	Ø32	20	-
10002403	Ø40	10	-

Tapë fundore PP-R



Kodi	Përmasat	Sasia	Cmimi
10002404	Ø50	6	-
10002405	Ø63	4	-
10002406	Ø75	2	-

Tapë prove



Kodi	Përmasat	Sasia	Cmimi
10002451	Ø25	25	-

Tapë prove



Kodi	Përmasat	Sasia	Cmimi
10043600	Ø20, e kuqe	10	-
10002450	Ø1/2M blu	10	-
10033600	Ø20, blu	10	-

Xhunto ovale PP-R



Kodi	Përmasat	Sasia	Cmimi
10002500	Ø40/Ø20	10	-
10002501	Ø40/Ø25	10	-
10002502	Ø50/Ø20	10	-

Xhunto ovale PP-R



Kodi	Përmasat	Sasia	Cmimi
10002503	∅50/∅25	10	-
10002504	∅63/∅20	10	-
10002505	∅63/∅25	10	-

Xhunto ovale PP-R



Kodi	Përmasat	Sasia	Cmimi
10002550	∅40X1/2" F.	10	-
10002551	∅40X3/4" F.	10	-
10002552	∅50X1/2" F.	10	-

Xhunto ovale PP-R



Kodi	Përmasat	Sasia	Cmimi
10002553	∅50X3/4" F	10	-
10002554	∅63X1/2" F.	10	-
10002555	∅63X3/4" F.	10	-

Hollandez PP-R



Kodi	Përmasat	Sasia	Cmimi
40000874	∅20	1	-
40000875	∅25	1	-

Hollandez PP-R



Kodi	Përmasat	Sasia	Cmimi
40000878	∅20X1/2"	1	-
40000879	∅25X3/4"	1	-
40001644	∅32X1" F	1	-

Hollandez PP-R



Kodi	Përmasat	Sasia	Cmimi
40000882	∅20X1/2"	1	-
40000883	∅25X3/4"	1	-
40001640	∅32X1"	1	-

Fasheta plastike PP-R



Kodi	Përmasat	Sasia	Cmimi
10002900	∅20	30	-
10002901	∅25	25	-
10002802	∅32	20	-
10002803	∅40	10	-

Fasheta plastike PP-R



Kodi	Përmasat	Sasia	Cmimi
10002850	∅20	30	-
10002851	∅25	25	-

Fasheta plastike PP-R



Kodi	Përmasat	Sasia	Cmimi
10003400	∅20	30	-
10003401	∅25	25	-
10003402	∅32	20	-

Kalese PP-R



Kodi	Përmasat	Sasia	Cmimi
10003000	∅20	10	-
10003001	∅25	10	-
10003002	∅32	10	-

Kalese PP-R



Kodi	Përmasat	Sasia	Cmimi
10003050	∅20	10	-
10003051	∅25	10	-
10003052	∅32	10	-

Kalese PP-R



Kodi	Përmasat	Sasia	Cmimi
10003053	∅20	20	-

Kalesa PP-R



Kodi	Përmasat	Sasia	Cmimi
10003100	Ø20	2	-

Saracineske PP-R



Kodi	Përmasat	Sasia	Cmimi
10003210	Ø20	10	-
10003211	Ø25	10	-
10003212	Ø32	5	-

Saracineske PP-R



Kodi	Përmasat	Sasia	Cmimi
10003210	Ø20	10	-
10003211	Ø25	10	-

Valvula me vidë fiksuere



Kodi	Përmasat	Sasia	Cmimi
10003300	Ø20	10	-
10003301	Ø25	10	-
10003302	Ø32	5	-

Valvula me vidë fiksuere



Kodi	Përmasat	Sasia	Cmimi
40001692	Ø40	10	-
40000902	Ø50	10	-
40001690	Ø63	10	-

Valvula sferike



Kodi	Përmasat	Sasia	Cmimi
10003700	Ø20	10	-
10003701	Ø25	10	-
10003702	Ø32	5	-

Valvul drenuese



Kodi	Përmasat	Sasia	Cmimi
10003300	Ø20	10	-
10003301	Ø25	10	-

Valvul me dy dalje



Kodi	Përmasat	Sasia	Cmimi
10003750	Ø20	10	-
10003751	Ø25	10	-

Grup montimi



Kodi	Përmasat	Sasia	Cmimi
10003500	2XØ20X1/2" F	5	-

TUBAT S LINE ME NJE DHE DY GOTA

Tub me nje gotë



Tub me nje gotë



Tub me nje gotë



Kodi	Përmasat	Sasia	Cmimi
10304500	ø32/150	10	-
10304501	ø32/250	10	-
10304502	ø32/500	10	-
10304503	ø32/750	10	-
10304504	ø32/1000	10	-
10304505	ø32/1500	10	-
10304506	ø32/2000	10	-
10304507	ø32/2500	10	-
10304508	ø32/3000	10	-
10304509	ø32/4000	10	-

Kodi	Përmasat	Sasia	Cmimi
10304520	ø40/150	10	-
10304521	ø40/250	10	-
10304522	ø40/500	10	-
10304524	ø40/1000	10	-
10304525	ø40/1500	10	-
10304526	ø40/2000	10	-
10304527	ø40/2500	10	-
10304528	ø40/3000	10	-
10304529	ø40/4000	10	-

Kodi	Përmasat	Sasia	Cmimi
10304540	ø50/150	10	-
10304541	ø50/250	10	-
10304542	ø50/500	10	-
10304543	ø50/750	10	-
10304544	ø50/1000	10	-
10304545	ø50/1500	10	-
10304546	ø50/2000	10	-
10304547	ø50/2500	10	-
10304548	ø50/3000	10	-
10304549	ø50/4000	10	-

Tub me nje gotë



Tub me nje gotë



Tub me nje gotë



Kodi	Përmasat	Sasia	Cmimi
10304560	ø75/150	10	-
10304561	ø75/250	10	-
10304562	ø75/500	10	-
10304563	ø75/750	10	-
10304564	ø75/1000	10	-
10304565	ø75/1500	10	-
10304566	ø75/2000	10	-
10304567	ø75/2500	10	-
10304568	ø75/3000	10	-
10304569	ø75/4000	10	-

Kodi	Përmasat	Sasia	Cmimi
10304580	ø90/150	10	-
10304581	ø90/250	10	-
10304582	ø90/500	10	-
10304583	ø90/750	10	-
10304584	ø90/1000	10	-
10304585	ø90/1500	10	-
10304586	ø90/2000	10	-
10304587	ø90/2500	10	-
10304588	ø90/3000	10	-
10304589	ø90/4000	10	-

Kodi	Përmasat	Sasia	Cmimi
10304600	ø110/150	10	-
10304601	ø110/250	10	-
10304602	ø110/500	10	-
10304604	ø110/1000	10	-
10304605	ø110/1500	10	-
10304606	ø110/2000	10	-
10304607	ø110/2500	10	-
10304608	ø110/3000	10	-
10304609	ø110/4000	10	-

Tub me nje gotë



Tub me nje gotë



Tub me nje gotë



Kodi	Përmasat	Sasia	Cmimi
10304620	ø125/150	10	-
10304621	ø125/250	10	-
10304622	ø125/500	10	-
10304624	ø125/1000	10	-
10304625	ø125/1500	10	-
10304626	ø125/2000	10	-
10304627	ø125/2500	10	-
10304628	ø125/3000	10	-
10304629	ø125/4000	10	-

Kodi	Përmasat	Sasia	Cmimi
10304640	ø160/150	10	-
10304641	ø160/250	10	-
10304642	ø160/500	10	-
10304643	ø160/750	10	-
10304644	ø160/1000	10	-
10304645	ø160/1500	10	-
10304646	ø160/2000	10	-
10304647	ø160/2500	10	-
10304648	ø160/3000	10	-
10304649	ø160/4000	10	-

Kodi	Përmasat	Sasia	Cmimi
10304700	ø200/500	10	-
10304701	ø200/750	10	-
10304702	ø200/1000	10	-
10304703	ø200/1500	10	-
10304704	ø200/2000	10	-
10304705	ø200/2500	10	-
10304706	ø200/3000	10	-
10304707	ø200/4000	10	-

Tub me nje gotë



Tub me dy gota



Tub me dy gota



Kodi	Përmasat	Sasia	Cmimi
10304730	ø250/500	10	-
10304731	ø250/750	10	-
10304732	ø250/1000	10	-
10304733	ø250/1500	10	-
10304734	ø250/2000	10	-
10304735	ø250/2500	10	-
10304736	ø250/3000	10	-
10304737	ø250/4000	10	-

Kodi	Përmasat	Sasia	Cmimi
10305000	ø32/500	10	-
10305002	ø32/1000	10	-
10305003	ø32/1500	10	-
10305004	ø32/2000	10	-
10305006	ø32/3000	10	-
10305020	ø40/500	10	-
10305022	ø40/1000	10	-
10305023	ø40/1500	10	-
10305024	ø40/2000	10	-
10305026	ø40/3000	10	-

Kodi	Përmasat	Sasia	Cmimi
10305040	ø50/500	10	-
10305041	ø50/750	10	-
10305042	ø50/1000	10	-
10305043	ø50/1500	10	-
10305044	ø50/2000	10	-
10305045	ø50/2500	10	-
10305046	ø50/3000	10	-
10305047	ø50/4000	10	-

TUBAT S LINE ME NJE DHE DY GOTA

Tub me dy gota



Kodi	Përmasat	Sasia	Cmimi
10305060	ø75/500	10	-
10305062	ø75/1000	10	-
10305063	ø75/1500	10	-
10305064	ø75/2000	10	-
10305065	ø75/2500	10	-
10305066	ø75/3000	10	-
10305067	ø75/4000	10	-

Tub me dy gota



Kodi	Përmasat	Sasia	Cmimi
10305080	ø90/500	10	-
10305082	ø90/1000	10	-
10305083	ø90/1500	10	-
10305084	ø90/2000	10	-
10305085	ø90/2500	10	-
10305086	ø90/3000	10	-
10305087	ø90/4000	10	-

Tub me dy gota



Kodi	Përmasat	Sasia	Cmimi
10305100	ø110/500	10	-
10305102	ø110/1000	10	-
10305103	ø110/1500	10	-
10305104	ø110/2000	10	-
10305105	ø110/2500	10	-
10305106	ø110/3000	10	-

Tub me dy gota



Kodi	Përmasat	Sasia	Cmimi
10305120	ø125/500	10	-
10305122	ø125/1000	10	-
10305123	ø125/1500	10	-
10305124	ø125/2000	10	-
10305125	ø125/2500	10	-
10305126	ø125/3000	10	-
10305127	ø125/4000	10	-

Tub me dy gota



Kodi	Përmasat	Sasia	Cmimi
10305140	ø160/500	10	-
10305142	ø160/1000	10	-
10305143	ø160/1500	10	-
10305144	ø160/2000	10	-
10305146	ø160/3000	10	-

Tub me dy gota



Kodi	Përmasat	Sasia	Cmimi
10305160	ø200/500	10	-
10305161	ø200/750	10	-
10305162	ø200/1000	10	-
10305163	ø200/1500	10	-
10305164	ø200/2000	10	-
10305165	ø200/2500	10	-
10305166	ø200/3000	10	-
10305167	ø200/4000	10	-

Tub me dy gota



Kodi	Përmasat	Sasia	Cmimi
10305180	ø250/500	10	-
10305181	ø250/750	10	-
10305182	ø250/1000	10	-
10305183	ø250/1500	10	-
10305184	ø250/2000	10	-
10305185	ø250/2500	10	-
10305186	ø250/3000	10	-
10305187	ø250/4000	10	-

Brryl S Line 15°



Kodi	Përmasat	Sasia	Cmimi
10304000	32/15°	10	-
10304001	40/15°	10	-
10304002	50/15°	10	-
10304003	75/15°	10	-
10304004	90/15°	10	-
10304005	110/15°	10	-
10304006	125/15°	10	-
10304007	160/15°	10	-
10304008	200/15°	10	-
10304009	250/15°	10	-

Brryl S Line 30°



Kodi	Përmasat	Sasia	Cmimi
10304020	32/30°	10	-
10304021	40/30°	10	-
10304022	50/30°	10	-
10304023	75/30°	10	-
10304024	90/30°	10	-
10304025	110/30°	10	-
10304026	125/30°	10	-
10304027	160/30°	10	-
10304028	200/30°	10	-
10304029	250/30°	10	-

Brryl S Line 45°



Kodi	Përmasat	Sasia	Cmimi
10304040	32/45°	10	-
10304041	40/45°	10	-
10304042	50/45°	10	-
10304043	75/45°	10	-
10304044	90/45°	10	-
10304045	110/45°	10	-
10304046	125/45°	10	-
10304047	160/45°	10	-
10304048	200/45°	10	-
10304049	250/45°	10	-

Brryl S Line 67,5°



Kodi	Përmasat	Sasia	Cmimi
10304060	32/67,5°	10	-
10304061	40/67,5°	10	-
10304062	50/67,5°	10	-
10304063	75/67,5°	10	-
10304064	90/67,5°	10	-
10304065	110/67,5°	10	-
10304066	125/67,5°	10	-
10304067	160/67,5°	10	-
10304068	200/67,5°	10	-
10304069	250/67,5°	10	-

Brryl S Line 87,5°



Kodi	Përmasat	Sasia	Cmimi
10304080	32/87,5°	10	-
10304081	40/87,5°	10	-
10304082	50/87,5°	10	-
10304083	75/87,5°	10	-
10304084	90/87,5°	10	-
10304085	110/87,5°	10	-
10304086	125/87,5°	10	-
10304087	160/87,5°	10	-
10304088	200/87,5°	10	-
10304089	250/87,5°	10	-

Ypsilon S Line 45°



Kodi	Përmasat	Sasia	Cmimi
10304100	32/32/45°	10	-
10304101	40/32/45°	10	-
10304102	40/40/45°	10	-
10304103	50/32/45°	10	-
10304104	50/40/45°	10	-
10304105	50/50/45°	10	-
10304106	75/40/45°	10	-
10304107	75/50/45°	10	-
10304108	75/75/45°	10	-
10304109	90/50/45°	10	-

RAKORDERITE S LINE

Ypsilon S Line 45°



Ypsilon S Line 45°



Ypsilon S Line 87,5°



Kodi	Përmasat	Sasia	Cmimi
10304110	90/75/45°	10	-
10304111	90/90/45°	10	-
10304112	110/40/45°	10	-
10304113	110/50/45°	10	-
10304114	110/75/45°	10	-
10304115	110/90/45°	10	-
10304116	110/110/45°	10	-
10304117	125/110/45°	10	-
10304118	125/125/45°	10	-
10304119	160/110/45°	10	-

Kodi	Përmasat	Sasia	Cmimi
10304120	160/110/45°	10	-
10304121	160/125/45°	10	-
10304122	160/160/45°	10	-
10304123	200/160/45°	10	-
10304124	200/200/45°	10	-
10304125	250/160/45°	10	-
10304126	250/200/45°	10	-
10304127	250/250/45°	10	-

Kodi	Përmasat	Sasia	Cmimi
10304130	32/32/87,5°	10	-
10304132	40/40/87,5°	10	-
10304134	50/40/87,5°	10	-
10304135	50/50/87,5°	10	-
10304136	75/40/87,5°	10	-
10304137	75/50/87,5°	10	-
10304138	75/75/87,5°	10	-
10304139	90/50/87,5°	10	-

Ypsilon S Line 87,5°



Brryl Ypsilon S Line 87,5°



Ypsilon I dyfishte S Line 87,5°



Kodi	Përmasat	Sasia	Cmimi
10304140	90/75/87.5°	10	-
10304141	90/90/87.5°	10	-
10304142	110/40/87.5°	10	-
10304143	110/50/87.5°	10	-
10304144	110/75/87.5°	10	-
10304145	110/90/87.5°	10	-
10304146	110/110/87.5°	10	-
10304147	125/90/87.5°	10	-
10304148	125/110/87.5°	10	-
10304149	125/125/87.5°	10	-

Kodi	Përmasat	Sasia	Cmimi
10304240	90/90/87.5°	10	-
10304241	110/90/87.5°	10	-
10304242	110/110/87.5°	10	-

Kodi	Përmasat	Sasia	Cmimi
10304190	50/90/50-45°	10	-
10304191	50/110/50-45°	10	-

Ypsilon Inspektimi S Line 87,5°



Kodi	Përmasat	Sasia	Cmimi
10304178	ø50	10	-
10304179	ø75	10	-
10304180	ø90	10	-
10304181	ø110	10	-
10304182	ø125	10	-
10304183	ø160	10	-

Manikote e dyfishte S Line



Kodi	Përmasat	Sasia	Cmimi
10304200	ø32	10	-
10304201	ø40	10	-
10304202	ø50	10	-
10304203	ø75	10	-
10304204	ø90	10	-
10304205	ø110	10	-

Manikote e dyfishte S Line



Kodi	Përmasat	Sasia	Cmimi
10304206	ø125	10	-
10304207	ø160	10	-
10304208	ø200	10	-
10304209	ø250	10	-

Manikote Inspektimi S Line



Kodi	Përmasat	Sasia	Cmimi
10304220	ø32	10	-
10304221	ø40	10	-
10304222	ø50	10	-
10304223	ø75	10	-
10304224	ø90	10	-

Manikote Inspektimi S Line



Kodi	Përmasat	Sasia	Cmimi
10304225	ø110	10	-
10304226	ø125	10	-
10304227	ø160	10	-
10304228	ø200	10	-
10304229	ø250	10	-

Ypsilon Inspektimi S Line



Kodi	Përmasat	Sasia	Cmimi
40006502	ø160/ø110/ø75	10	-
40006918	ø110/ø110/ø75	10	-

Reduktues S Line



Kodi	Përmasat	Sasia	Cmimi
10304160	40/32	10	-
10304161	32/40	10	-
10304162	40/50	10	-
10304163	50/40	10	-
10304164	75/50	10	-
10304165	90/40	10	-
10304166	90/50	10	-
10304167	90/75	10	-
10304168	90/110	10	-
10304169	90/125	10	-

Reduktues S Line



Kodi	Përmasat	Sasia	Cmimi
10304170	110/40	10	-
10304171	110/50	10	-
10304172	110/75	10	-
10304173	125/110	10	-
10304175	160/125	10	-
10304184	200/160	10	-
10304185	250/200	10	-

Tape S Line



Kodi	Përmasat	Sasia	Cmimi
10304260	ø32	10	-
10304261	ø40	10	-
10304262	ø50	10	-
10304263	ø75	10	-
10304264	ø90	10	-
10304265	ø110	10	-
10304266	ø125	10	-
10304267	ø160	10	-

Inspektues P , Blu , S Line



Kodi	Përmasat	Sasia	Cmimi
40006639	DN 110 MM	10	-

Inspektues Dyshemeje , S Line



Kodi	Përmasat	Sasia	Cmimi
40006640	DN 110/DN75/ DN50 MM	10	-

Inspektues I thelle dyshemeje S Line



Kodi	Përmasat	Sasia	Cmimi
40006641	DN110/75/50 MM	10	-

Panele Diellore

Ngrohje & Ftohje

Hidraulike

Hidrosanitare

Aksesore të ndryshëm

Tub HTPP , Gri



Tub HTPP , Gri



Tub HTPP , Gri



Kodi	Përmasat	Sasia	Cmimi
10200001	Ø32/250	1	-
10200002	Ø32/500	10	-
10200004	Ø 32/1000	10	-
10200005	Ø 32/1500	10	-
10200006	Ø32/2000	10	-
10200007	Ø32/3000	10	-
10200008	Ø32/4000	10	-
10200021	Ø40/250	1	-
10200022	Ø40/500	1	-
10200024	Ø40/1000	10	-
10200025	Ø40/1500	10	-
10200026	Ø40/2000	10	-
10200027	Ø40/3000	10	-
10200028	Ø40/4000	10	-
10200041	Ø50/250	1	-
10200042	Ø50/500	1	-
10200044	Ø50/1000	10	-
10200045	Ø50/1500	10	-
10200046	Ø50/2000	10	-
10200047	Ø50/3000	10	-

Kodi	Përmasat	Sasia	Cmimi
10200048	Ø50/4000	10	-
10200101	Ø75/250	1	-
10200102	Ø75/500	10	-
10200104	Ø75/1000	10	-
10200105	Ø75/1500	10	-
10200106	Ø75/2000	10	-
10200107	Ø75/3000	10	-
10200108	Ø75/4000	10	-
10200151	Ø90/250	1	-
10200152	Ø90/500	1	-
10200154	Ø90/1000	10	-
10200155	Ø90/1500	10	-
10200156	Ø90/2000	10	-
10200158	Ø90/4000	10	-
10200159	Ø160/3000	10	-
10200201	Ø110/250	1	-
10200202	Ø110/500	1	-
10200204	Ø110/1000	10	-
10200205	Ø110/1500	10	-
10200206	Ø110/2000	10	-

Kodi	Përmasat	Sasia	Cmimi
10200211	Ø110/2500	10	-
10200207	Ø110/3000	10	-
10200208	Ø110/4000	10	-
10200221	Ø125/250	1	-
10200222	Ø125/500	1	-
10200224	Ø125/1000	8	-
10200225	Ø125/1500	8	-
10200226	Ø125/2000	8	-
10200231	Ø125/2500	8	-
10200227	Ø125/3000	8	-
10200228	Ø125/4000	8	-
10200241	Ø160/250	1	-
10200242	Ø160/500	1	-
10200244	Ø160/1000	6	-
10200245	Ø160/1500	6	-
10200246	Ø160/2000	6	-
10200247	Ø160/3000	6	-
10200248	Ø160/4000	6	-

Tub me 2 gota HTPP , Gri



Kodi	Përmasat	Sasia	Cmimi
19906503	ø32/500	25	-
19906500	ø32/1000	10	-
19906501	ø32/2000	10	-
19906502	ø32/3000	10	-
19906510	ø40/500	25	-
19906511	ø40/1000	10	-
19906514	ø40/1500	10	-
19906512	ø40/2000	10	-
19906513	ø40/3000	10	-
19906520	ø50/500	25	-
19906521	ø50/1000	10	-
19906522	ø50/2000	10	-

Tub me 2 gota HTPP , Gri



Kodi	Përmasat	Sasia	Cmimi
19906523	ø50/3000	10	-
19906530	ø75/500	10	-
19906532	ø75/1000	10	-
19906533	ø75/2000	10	-
19906640	ø75/3000	10	-
19906642	ø90/500	10	-
19906643	ø90/1000	10	-
19906644	ø90/1500	10	-
19906646	ø90/2000	10	-
19906540	ø90/3000	10	-
19906541	ø110/500	10	-
19906544	ø110/1000	10	-

Tub me 2 gota HTPP , Gri



Kodi	Përmasat	Sasia	Cmimi
19906542	ø110/2000	10	-
19906543	ø110/3000	10	-
19906550	ø125/500	8	-
19906551	ø125/1000	8	-
19906552	ø125/2000	8	-
19906553	ø125/3000	8	-
19906560	ø160/500	6	-
19906561	ø160/1000	6	-
19906562	ø160/2000	6	-
19906563	ø160/3000	6	-
			-
			-

Brryl HTPP , Gri



Kodi	Përmasat	Sasia	Cmimi
10200329	ø90/15°	40	-
10200330	ø32/15°	100	-
10200332	ø50/15°	60	-
10200333	ø75/15°	35	-
10200346	ø110/15°	30	-
10200529	ø90/30°	20	-
10200530	ø32/30°	55	-
10200532	ø50/30°	40	-
10200533	ø75/30°	100	-
10200547	ø110/30°	60	-
10200630	ø32/45°	40	-

Brryl HTPP , Gri



Kodi	Përmasat	Sasia	Cmimi
10200632	ø50/45°	60	-
10200633	ø75/45°	20	-
10200634	ø110/45°	20	-
10200635	ø125/45°	10	-
10200637	ø90/45°	50	-
10200830	ø32/87,5°	40	-
10200832	ø50/87,5°	30	-
10200833	ø75/87,5°	80	-
10200837	ø90/87,5°	50	-
10200851	ø110/87,5°	30	-
10200835	ø125/87,5°	20	-

Ypsilon HTPP 45°



Kodi	Përmasat	Sasia	Cmimi
10200970	ø32/ø32/45°	40	-
10200971	ø40/ø32/45°	30	-
10200972	ø40/ø40/45°	25	-
10200973	ø50/ø32/45°	40	-
10200974	ø50/ø50/45°	20	-
10200975	ø50/ø50/45°	25	-
10200976	ø75/ø75/45°	25	-
10200977	ø75/ø75/45°	15	-
10200979	ø110/ø75/45°	15	-
10200981	ø125/ø110/45°	8	-
10200982	ø125/ø125/45°	5	-

Ypsilon HTPP 45°



Kodi	Përmasat	Sasia	Cmimi
10200983	Ø160/Ø110/45°	5	-
10200984	Ø160/Ø125/45°	5	-
10200985	Ø160/Ø160/45°	4	-
10200986	Ø90/Ø90/45°	20	-
10200987	Ø110/Ø32/45°	30	-
10200988	Ø110/Ø40/45°	30	-
10201057	Ø110/Ø50/45°	40	-
10201058	Ø110/Ø110/45°	20	-

Ypsilon HTPP 67.5°



Kodi	Përmasat	Sasia	Cmimi
10201060	Ø32/Ø32/67,5°	50	-
10201061	Ø40/Ø40/67,5°	25	-
10201062	Ø50/Ø50/67,5°	30	-
10201063	Ø110/Ø50/67,5°	25	-
10201064	Ø110/Ø110/67,5°	10	-

Ypsilon HTPP 90°



Kodi	Përmasat	Sasia	Cmimi
10201180	Ø32/Ø32/87,5°	50	-
10201181	Ø40/Ø32/87,5°	30	-
10201182	Ø40/Ø40/87,5°	25	-
10201183	Ø50/Ø32/87,5°	20	-
10201184	Ø50/40/87,5°	20	-
10201185	Ø50/Ø50/87,5°	30	-
10201186	Ø75/Ø50/87,5°	25	-
10201187	Ø75/Ø75/87,5°	20	-

Ypsilon HTPP 90°



Kodi	Përmasat	Sasia	Cmimi
10201189	Ø110/Ø75/87,5°	15	-
10201191	Ø125/Ø110/87,5°	9	-
10201192	Ø125/Ø125/87,5°	10	-
10201193	Ø160/Ø110/87,5°	5	-
10201194	Ø160/Ø125/87,5°	5	-
10201195	Ø160/Ø160/87,5°	4	-
10201196	Ø90/Ø90/87,5°	25	-
10201197	Ø110/Ø32/87,5°	30	-
10201198	Ø110/Ø40/87,5°	28	-

Ypsilon i dyfishte HTPP



Kodi	Përmasat	Sasia	Cmimi
10201560	Ø50/Ø50/Ø50/45°	15	-
10201561	Ø50/Ø110/Ø50/45°	15	-
10201562	Ø110/Ø110/Ø110/45°	5	-
10201660	Ø50/Ø50/Ø50/67,5°	15	-
10201661	Ø50/Ø110/Ø50/67,5°	15	-
10201662	110/Ø110/Ø110/67,5°	9	-

Ypsilon i dyfishte HTPP 90°



Kodi	Përmasat	Sasia	Cmimi
10201760	Ø50/Ø110/Ø50/87,5	15	-
10201761	Ø110/Ø110/Ø110/87,5	8	-

Reduksion HTPP



Kodi	Përmasat	Sasia	Cmimi
10201270	Ø40/Ø32	80	-
10201271	Ø50/Ø32	60	-
10201272	Ø50/Ø40	40	-
10201274	Ø75/Ø50	55	-
10201277	Ø125/Ø110	35	-

Reduksion HTPP



Kodi	Përmasat	Sasia	Cmimi
10201278	Ø160/Ø110	25	-
10201279	Ø160/Ø125	25	-
10201280	Ø90/Ø32	40	-
10201281	Ø90/Ø40	40	-

Tub inspektimi HTPP



Kodi	Përmasat	Sasia	Cmimi
10201420	Ø50	30	-
10201421	Ø575	20	-
10201423	Ø5125	10	-
10201425	Ø110	32	-
10201426	Ø90	20	-

Tub inspektimi HTPP



Kodi	Përmasat	Sasia	Cmimi
10202124	Ø50	50	-
10202140	Ø32	50	-
10202141	Ø40	40	-

Tape HTPP



Kodi	Përmasat	Sasia	Cmimi
10202250	Ø32	400	-
10202251	Ø40	300	-
10202252	Ø50	150	-
10202253	Ø75s	50	-

Tape HTPP



Kodi	Përmasat	Sasia	Cmimi
10202254	Ø110	30	-
10202255	Ø125	15	-
10202256	Ø160	25	-

Manikote dyfishte HTPP



Kodi	Përmasat	Sasia	Cmimi
10202320	Ø32	90	-
10202321	Ø40	50	-
10202322	Ø50	30	-
10202323	Ø75	25	-
10202324	Ø110	45	-
10202325	Ø125	20	-
10202339	Ø90	20	-

Manikote tape HTPP



Kodi	Përmasat	Sasia	Cmimi
10202418	Ø90	20	-
10202420	Ø32	90	-
10202421	Ø40	50	-
10202422	Ø50	30	-
10202423	Ø75	25	-
10202425	Ø125	20	-
10202440	Ø110	60	-

Kapele ajrimi HTPP



Kodi	Përmasat	Sasia	Cmimi
10202710	Ø50	30	-
10202711	Ø75	15	-
10202712	Ø110	20	-
10202714	Ø160	5	-

Reduksion HTPP



Kodi	Përmasat	Sasia	Cmimi
10299000	Ø50	25	-
10299001	Ø50	25	-
10299002	Ø75	25	-
10299005	Ø110	10	-
10299006	Ø75	20	-
10299010	Ø110	10	-

Tubat HDPE , PN10



Kodi	Përmasat	Gj. e spirales (m)	Cmimi
11100815	PN10 Ø20	100	-
11200815	PN10 Ø25	100	-
11200816	PN10 Ø32	100	-
11200817	PN10 Ø40	100	-
11200818	PN10 Ø50	100	-
11200819	PN10 Ø63	100	-
11200820	PN10 Ø75	100	-
11200821	PN10 Ø90	100	-
11200822	PN10 Ø110	100	-

Panele Diellore

Ngrohje & Ftohje

Hidraulike

Hidrosanitare

Aksesore të ndryshëm

ATUSA Tubo celiku, xingato, rakorderi

Tubo celiku pa tegel



Tubo celiku me tegel



Tubo xingato



Kodi	Përmasat	Cmimi
153002	114.3*4mm -(4")	-
151003	26.9x2.9mm(3/4"-6.13 ml)	-
151302	33.7*2.9mm- (1")	-
151502	42.4*2.9mm- (1.1/4")	-
151503	42.4x3.2mm(1.1/4"-6.08 ml)	-
151702	48.3*2.9mm- (1.1/2")	-
151703	48.3x3.2mm(1.1/2"-6.85 ml)	-
152101	60.3*2.9mm- (2")	-
152102	60.3x3.2mm(2"-6.05 ml)	-
152501	76.1*2.9mm-(2.1/2")	-
152702	88.9*3.6mm- (3")	-

Kodi	Përmasat	Cmimi
140704	1/2"	-
140705	3/4"	-
140706	1"	-
140707	1 1/4"	-
140708	1 1/2"	-
140709	2"	-
140710	2 1/2"	-
140711	3"	-
140712	4"	-

Kodi	Përmasat	Cmimi
140904	1/2"	-
140905	3/4"	-
140906	1"	-
140907	1 1/4"	-
140908	1 1/2"	-
140909	2"	-
140910	2 1/2"	-
140911	3"	-
140912	4"	-

Brryl xingato me filet



Brryl xingato me filet



Hollandez xingato me filet



Kodi	Përmasat	Cmimi
XBFF0012	90° - 1/2 "	-
XBFF0034	90° - 3/4 "	-
XBFF0001	90° - 1 "	-
XBFF0114	90° - 1 1/4 "	-
XBFF0112	90° - 1 1/2 "	-
XBFF0002	90° - 2 "	-
XBFF0212	90° - 2*1/2 «	-
XBFF0003	90° - 3 "	-
XBFF0004	90° - 4 "	-

Kodi	Përmasat	Cmimi
XBMF0012	90° - 1/2 "	-
XBMF0034	90° - 3/4 "	-
XBMF0001	90° - 1 "	-
XBMF0114	90° - 1 1/4 "	-
XBMF0112	90° - 1 1/2 "	-
XBMF0002	90° - 2 "	-
XBMF0212	90° - 2 1/2 "	-
XBMF0003	90° - 3 "	-
XBMF0004	90° - 4 "	-

Kodi	Përmasat	Cmimi
XHFF0012	1/2"	-
XHFF0034	3/4"	-
XHFF0001	1"	-
XHFF0114	1 1/4"	-
XHFF0112	1 1/2"	-
XHFF0002	2"	-
XHFF0212	2 1/2"	-
XHFF0003	3"	-
XHFF0004	4"	-

Rakorderi xingato
Manikota xingato me filet

Kodi	Përmasat	Cmimi
XM000034	3/4"	-
XM000012	1/2"	-
XM000114	1 1/4"	-
XM000112	1 1/2"	-
XM000001	1"	-
XM000002	2"	-
XM000212	2 1/2"	-
XM000003	3"	-
XM000004	4"	-

Nipel xingato me filet

Kodi	Përmasat	Cmimi
XN000034	3/4"	-
XN000012	1/2"	-
XN000001	1"	-
XN000114	1 1/4"	-
XN000112	1 1/2"	-
XN000002	2"	-
XN000212	2 1/2"	-
XN000003	3"	-
XN000004	4"	-

Reduksion xingato me filet

Kodi	Përmasat	Cmimi
XRFF0134	1"x1/2"	-
XRFF01121	1"x3/4"	-
XRFF11412	1 1/4"*1/2"	-
XRFF11434	1 1/4"*3/4"	-
XRFF01141	1 1/4"*1"	-
XRFF11212	1 1/2"*1/2"	-
XRFF11234	1 1/2"*3/4"	-
XRFF1121	1 1/2"*1"	-
XRFF112114	1 1/2"*1 1/4"	-
XRFF00212	2"*1/2"	-
XRFF00234	2"*3/4"	-
XRFF00021	2"*1"	-
XRFF02114	2"*1 1/4"	-
XRFF02112	2"*1 1/2"	-

Reduksion xingato me filet

Kodi	Përmasat	Cmimi
XRMF03412	3/4"*1/2"	-
XRMF00212	2"*1/2"	-
XRMF00234	2"*3/4"	-
XRMF02114	2"*1 1/4"	-
XRMF02112	2"*1 1/2"	-

Reduksion xingato me filet

Kodi	Përmasat	Cmimi
XRMF0112	1"*1/2"	-
XRMF0134	1"*3/4"	-
XRMF11412	1 1/4"*1/2"	-
XRMF11434	1 1/4"*3/4"	-
XRMF01141	1 1/4"*1"	-
XRMF11212	1 1/2"*1/2"	-
XRMF11234	1 1/2"*3/4"	-
XRMF1121	1 1/2"*1"	-
XRMF112114	1 1/2"*1 1/4"	-
XRMF00021	2"*1"	-

Ti xingato me filet

Kodi	Përmasat	Cmimi
XT000114	1/2"	-
XT000112	1 1/4"	-
XT000001	1 1/2"	-
XT000012	2 1/2"	-
XT000002	3"	-
XT000212	2"	-
XT000003	2 1/2"	-
XT000034	3"	-
XT000004	3/4"	-
XT00000x	4"	-

Panele Diellore

Ngrhje & Ftohje

Hidraulike

Hidrosanitare

Aksesore të ndryshëm

Rakorderi xingato

Brryl xingato me filet



Kodi	Përmasat	Cmimi
020105	90° - 3/4"	-
020106	90° - 1"	-
020107	90° - 1 1/4"	-
020108	90° - 1 1/2"	-

Reduksion xingato me filet



Kodi	Përmasat	Cmimi
022019	1 1/4"*1"	-
022022	1 1/2"*1"	-
022026	2"*1"	-
022028	2"*1 1/2"	-

Ti xingato me filet



Kodi	Përmasat	Cmimi
022207	3/4"	-
022212	1"	-
022205	2"	-
022209	2 1/2"	-
022206	3"	-

Hollandez xingato me filet



Kodi	Përmasat	Cmimi
021104	1/2"	-
021112	4"	-

Reduksion xingato me filet



Kodi	Përmasat	Cmimi
020822	1 1/2"*1"	-
020823	1 1/2"*1 1/4"	-

Tapa xingato me filet



Kodi	Përmasat	Cmimi
021011	2 1/2"	-
022208	3"	-

Manikota xingato me filet



Kodi	Përmasat	Cmimi
021705	3/4"	-
50807	1 1/4"	-
21707	1 1/4"	-
050808	1 1/2"	-
021708	1 1/2"	-
050809	2"	-

Nipel xingato me filet



Kodi	Përmasat	Cmimi
020706	1"	-
020707	1 1/4"	-
020708	1 1/2"	-
020709	2"	-
020710	2*1 1/2"	-

Reduksion xingato me filet



Kodi	Përmasat	Cmimi
021010	3/4"x1/2"	-
022017	1 1/4"*1/2"	-
022122	1 1/2"*1"	-
022128	2"*1 1/2"	-

Tapa xingato me filet



Kodi	Përmasat	Cmimi
XTM00212	1/2"	-
XTM00002	3/4"	-
XTM00112	1"	-
XTM00012	1 1/4"	-
XTM00114	1 1/2"	-
XTM00001	2"	-
XTM00003	2 1/2"	-
XTM00034	3"	-

Brryl i zi



Brryl i zi



Hollandez i zi



Kodi	Përmasat	Cmimi
XBZFF012	90° - 1/2"	-
XBZFF001	90° - 1"	-
XBZFF114	90° - 1 1/4"	-
XBZFF112	90° - 1 1/2"	-
XBZFF002	90° - 2"	-
XBZFF212	90° - 2 1/2"	-
XBZFF003	90° - 3"	-
XBZFF004	90° - 4"	-

Kodi	Përmasat	Cmimi
XBZMF012	90° - 1/2"	-
XBZMF034	90° - 3/4"	-
XBZMF001	90° - 1"	-
XBZMF114	90° - 1 1/4"	-
XBZMF112	90° - 1 1/2"	-
XBZMF002	90° - 2"	-
XBZMF212	90° - 2 1/2"	-
XBZMF003	90° - 3"	-
XBZMF004	90° - 4"	-

Kodi	Përmasat	Cmimi
XHZFF012	1/2"	-
XHZFF034	3/4"	-
XHZFF001	1"	-
XHZFF114	1 1/4"	-
XHZFF112	1 1/2"	-
XHZFF002	2"	-
XHZFF212	2 1/2"	-
XHZFF003	3"	-
XHZFF004	4"	-

Manikote e zeze



Nipel e zeze



Reduksion i zi



Kodi	Përmasat	Cmimi
XMZ00012	1/2"	-
XMZ00034	3/4"	-
XMZ00001	1"	-
XMZ00114	1 1/4"	-
XMZ00112	1 1/2"	-
XMZ00002	2"	-
XMZ00212	2 1/2"	-
XMZ00003	3"	-
XMZ00004	4"	-

Kodi	Përmasat	Cmimi
XNZ00012	1/2"	-
XNZ00034	3/4"	-
XNZ00001	1"	-
XNZ00114	1 1/4"	-
XNZ00112	1 1/2"	-
XNZ00002	2"	-
XNZ00212	2 1/2"	-
XNZ00003	3"	-
XNZ00004	4"	-

Kodi	Përmasat	Cmimi
XRZFF03412	3/4" * 1/2"	-
XRZFF00112	1" * 1/2"	-
XRZFF00134	1" * 3/4"	-
XRZF011412	1 1/4" * 1/2"	-
XRZFF11434	1 1/4" * 3/4"	-
XRZFF01141	1 1/4" * 1"	-
XRZFF11212	1 1/2" * 1/2"	-
XRZFF01121	1 1/2" * 1"	-
XRZFF212	2" * 1/2"	-
XRZFF234	2" * 3/4"	-
XRZFF00021	2" * 1"	-
XRZFF02114	2" * 1 1/4"	-
XRZFF02112	2" * 1 1/2"	-

Rakorderi te zeza

Reduksion i zi



Tape e zeze



Ti e zeze



Kodi	Përmasat	Cmimi
XRZMF03412	3/4"*1/2"	-
XRZMF00112	1"*1/2"	-
XRZMF00134	1"*3/4"	-
XRZMF11434	1 1/4"*3/4"	-
XRZMF1141	1 1/4"*1"	-
XRZMF11212	1 1/2"*1/2"	-
XRZFF11234	1 1/2"*3/4"	-
XRZMF01121	1 1/2"*1"	-
XRZMF00021	2"*1"	-
XRZMF02114	2"*1 1/4"	-
XRZMF02112	2"*1 1/2"	-

Kodi	Përmasat	Cmimi
XTMZ00012	1/2"	-
XTMZ00034	3/4"	-
XTMZ00001	1"	-
XTMZ00114	1 1/4"	-
XTMZ00112	1 1/2"	-
XTMZ00002	2"	-
XTMZ00212	2 1/2"	-
XTMZ00003	3"	-

Kodi	Përmasat	Cmimi
XTZ00012	1/2"	-
XTZ00034	3/4"	-
XTZ00001	1"	-
XTZ00114	1 1/4"	-
XTZ00112	1 1/2"	-
XTZ00002	2"	-
XTZ00212	2 1/2"	-
XTZ00003	3"	-
XTZ00004	4"	-

Brryl celiku me saldime



Reduksion celiku me saldime



Ti celiku me saldime



Kodi	Përmasat	Cmimi
180104	1/2 " 90 °	-
180105	3/4 " 90 °	-
180106	1 " 90 °	-
180107	1 1/4 " 90 °	-
180108	1 1/2 " 90 °	-
180209	2" 45 °	-
180109	2 " 90 °	-
180110	2 1/2 " 90 °	-

Kodi	Përmasat	Cmimi
181002	3/4"*1/2"	-
181004	1"*1/2"	-
181007	1.1/4"*1/2"	-
181009	1.1/4"*1"	-
181011	1.1/2"*1/2"	-
181013	1.1/2"*1"	-
181014	1.1/2"*1.1/4"	-
181016	2"*1/2"	-
181018	2"*1"	-
181019	2"*1.1/4"	-
181020	2"*1.1/2"	-

Kodi	Përmasat	Cmimi
180604	1/2"	-
180605	3/4"	-
180606	1"	-
180607	1 1/4"	-
180608	1 1/2"	-
180609	2"	-

Kalorifer banjo

Kalorifer banjo



Kodi	Përshkrimi	Cmimi
GXC500-1360	kalorifer banje I kromuar bombe 500x1360	-

Kalorifer banjo

Kalorifer banjo



Kodi	Përshkrimi	Cmimi
GXC500-1700	kalorifer banje I kromuar bombe 500x1700	-

Kalorifer banjo

Kalorifer banjo



Kodi	Përshkrimi	Cmimi
G500-830	kalorifer banje I bardhe 500x830	-

Kalorifer banjo



Kodi	Përshkrimi	Cmimi
G500-950	kalorifer banje I bardhe 500x950	-

Kalorifer banjo



Kodi	Përshkrimi	Cmimi
G500-1000	kalorifer banje I bardhe 500x1000	-

Kalorifer banjo



Kodi	Përshkrimi	Cmimi
G500-1200	kalorifer banje I bardhe 500x1200	-

Kalorifer banjo



Kodi	Përshkrimi	Cmimi
G500-1360	kalorifer banje I bardhe 500x1360	-

Kalorifer banjo



Kodi	Përshkrimi	Cmimi
G600-1360	kalorifer banje I bardhe 600x1360	-

Kalorifer banjo



Kodi	Përshkrimi	Cmimi
G500-1700	kalorifer banje I bardhe 500x1700	-

Kalorifer banjo



Kodi	Përshkrimi	Cmimi
GC500-120	kalorifer banje I bardhe bombe 500x1200	-

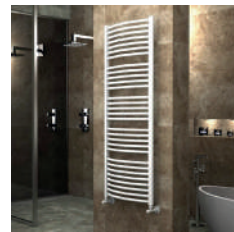

Kodi	Përshkrimi	Cmimi
GC500-136	kalorifer banje I bardhe bombe 500x1360	-

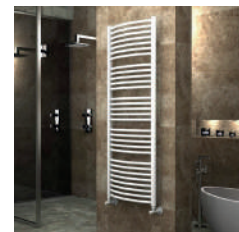

Kodi	Përshkrimi	Cmimi
GC500-170	kalorifer banje I bardhe bombe 500x1700	-

Panele Diellore

Ngrohje & Ftohje

Hidraulike

Hidrosanitare

Aksesore të ndryshëm

Aksesor

Kit radiatori



Kodi	Përshkrimi	Cmimi
DO01	Kit per radiator alumini	-

Rezistence



Kodi	Përshkrimi	Cmimi
DO88	Rezistence per kalorifer banjo 900W me timer+touch,metalizato	-

Rezistence



Kodi	Përshkrimi	Cmimi
DO85	Rezistence kalorifer banjo 600 w me timer+touch, e bardhe	-

Shufra argjendj



Kodi	Përshkrimi	Cmimi
FB092	Shufer argjendi	-

Set reduksioni



Kodi	Përshkrimi	Cmimi
DO02	Set reduksioni per radiator alumini	-

Rezistence



Kodi	Përshkrimi	Cmimi
DO87	Rezistence kalorifer banjo 600 w me timer+touch, metalizato	-

Kanelle



Kodi	Përshkrimi	Cmimi
DO28	Kanelle hidraulike-290 HT 1	-

Teflon



Kodi	Përshkrimi	Cmimi
DO31	Teflon Ø3/4	-

Ganxha



Kodi	Përshkrimi	Cmimi
DO03	Ganxha per set reduksioni per radiator alumini	-

Rezistence



Kodi	Përshkrimi	Cmimi
DO86	Rezistence kalorifer banjo 900 w me timer+touch, e bardhe	-

Kanelle



Kodi	Përshkrimi	Cmimi
DO29	Kanelle hidraulike me magnet-290 HZ8066B	-

Map Gas



Kodi	Përshkrimi	Cmimi
DO48	Map Gas 400 gr Delka Pro	-

Aksesore

Lesh Liri



Koke dushi



Koke dushi



Kodi	Përshkrimi	Cmimi
DO45	Lesh Liri	-

Kodi	Përshkrimi	Cmimi
DO46	Koke dshi me 3-funksione	-

Kodi	Përshkrimi	Cmimi
DO47	Koke dushi me 3-funksione +filter	-

Veshje me ngjites



Veshje me ngjites



Perese tubi



Kodi	Përshkrimi	Cmimi
GE009	Veshje tubi me ngjites rrole 50mmx3mmx10m Gento	-

Kodi	Përshkrimi	Cmimi
D022	Veshje tubi me ngjites rrole 10ml	-

Kodi	Përshkrimi	Cmimi
DO30	Perese tubi bakri Ø6-42	-

Fole e zeze



Valvul termike&preesioni



Fole e verdhe



Kodi	Përshkrimi	Cmimi
195-2-F116	Fole te zeza per pex+brryl 16x1/2 f	-

Kodi	Përshkrimi	Cmimi
D059	Valvul termike&presioni per panel diellor 22x3/4"	-

Kodi	Përshkrimi	Cmimi
195-4	Fole te verdha per pex-al&brryl 16x1/2f	-

Brryl Bakri



Bashkues bakri



Tap bakri



Kodi	Përshkrimi	Cmimi
D1007	Brryl per tub bakri me shtrengim Ø22x3/4m	-

Kodi	Përshkrimi	Cmimi
AS305	Bashkues tubi bakri Ø22x22	-

Kodi	Përshkrimi	Cmimi
AS310	Tapa bakri Ø22x3/4"f	-

Panele Diellore

Ngrohje & Ftohje

Hidraulike

Hidrosanitare

Aksesore të ndryshëm

Fasheta bakri

Fasheta bakri



Kodi	Përshkrimi	Cmimi
HTM018	Fasheta bakri teke Ø18	-
HTM020	Fasheta bakri teke Ø35	-
HTM021	Fasheta bakri teke Ø42	-
		-
		-
		-
		-

Fasheta bakri



Kodi	Përshkrimi	Cmimi
DO34	Fasheta bakri teke Ø15	-
DO35	Fasheta bakri teke Ø22	-
DO36	Fasheta bakri teke Ø28	-
DO37	Fasheta bakri teke Ø54	-
		-
		-
		-

Fasheta bakri



Kodi	Përshkrimi	Cmimi
DO38	Fasheta bakri dopjo Ø15	-
DO39	Fasheta bakri dopjo Ø18	-
DO40	Fasheta bakri dopjo Ø22	-
DO41	Fasheta bakri dopjo Ø28	-
DO42	Fasheta bakri dopjo Ø35	-
DO43	Fasheta bakri dopjo Ø42	-
DO44	Fasheta bakri dopjo Ø44	-

Fasheta me gomine



Kodi	Përshkrimi	Cmimi
DO49	Fasheta me gomine Ø32	-
DO50	Fasheta me gomine Ø40	-
DO51	Fasheta me gomine Ø50	-
DO52	Fasheta me gomine Ø63	-
DO53	Fasheta me gomine Ø75	-
DO54	Fasheta me gomine Ø100	-
DO55	Fasheta me gomine Ø125	-
		-

Fasheta me gomine



Kodi	Përshkrimi	Cmimi
DO75	Fasheta metalike me gomine Ø25-29x3/4"	-
DO76	Fasheta metalike me gomine Ø32-36x1"	-
DO77	Fasheta metalike me gomine Ø41-45x1.1/4"	-
DO78	Fasheta metalike me gomine Ø49-53x1.1/2"	-
DO79	Fasheta metalike me gomine Ø59-65x2"	-
DO80	Fasheta metalike me gomine Ø75-83x2.1/2"	-
DO81	Fasheta metalike me gomine Ø97-101x3.1/2"	-
DO82	Fasheta metalike me gomine Ø110-4"	-

Dizha, kaldaj celiku, prese

Dizha metalike



Dizha metalike



Kaldaje Celiku



Kodi	Përshkrimi	Cmimi
DO83	Dizha metalike Ø8 (4003-8)	-

Kodi	Përshkrimi	Cmimi
DO84	Dizha metalike Ø10 (4003-10)	-

Kodi	Përshkrimi	Cmimi
DO04	Kaldaj celiku me naftë NB-EN290-337 kw	-

Kaldaje Celiku



Kaldaje Celiku



Kaldaje Celiku



Kodi	Përshkrimi	Cmimi
DO05	Kaldaj celiku me naftë NB-EN90-105 kw	-

Kodi	Përshkrimi	Cmimi
DO26	Kaldaj celiku me naftë NB-EN210-244 kw	-

Kodi	Përshkrimi	Cmimi
DO60	Kaldaj celiku me naftë NB-EN60-70 kw	-

Kaldaje Celiku



Prese kontrolli



Prese kontrolli



Kodi	Përshkrimi	Cmimi
DO61	Kaldaj celiku me naftë NB-EN130-140 kw	-

Kodi	Përshkrimi	Cmimi
DO66	Prese kontrolli PC-10 1.1 kw	-

Kodi	Përshkrimi	Cmimi
DO67	Prese kontrolli PC-15 + manometra 1.1 kw	-

Panele Dielllore

Ngrohje & Ftohje

Hidraulike

Hidrosanitare

Aksesore të ndryshëm

Grupe Inoksi

Grup Lavapjate



Kodi	Përshkrimi	Cmimi
DO32	Grup lavapjate inoksi-creta cod.4002	-

Grup Lavapjate



Kodi	Përshkrimi	Cmimi
DO62	Grup lavapjate inoksi-creta cod.4004	-

Grup bideje



Kodi	Përshkrimi	Cmimi
DO63	Grup bideje inoksi-creta cod.4008	-

Grup lavamani



Kodi	Përshkrimi	Cmimi
DO64	Grup lavamani inoksi-creta cod.4007	-

Grup dushi



Kodi	Përshkrimi	Cmimi
DO65	Grup dushi inoksi-creta cod.4006	-

Ona

Simple as nature. Ona pays homage to the diverse shapes of nature from our native Mediterranean. It is functional without ever appearing cold, with crisp aesthetics that follow the inherent warmth of the natural environment, made for those who enjoy the power of silent landscapes.



Ona collection

Një nga koleksionet më ekskluzive të porcelanit të Roca-s për ata që duan të shkojnë një hap më tej në kërkimin e inovacionit dhe dizajnit.



Roca
SERIA BEYOND

Roca-WC S&C



Kodi	Përshkrimi	Cmimi
A801B8200B	WC	-

Roca-WC



Kodi	Përshkrimi	Cmimi
A3460B7000	WC	-

Roca-Bide



Kodi	Përshkrimi	Cmimi
A3570B6000	Bide	-

Roca-Kapak bideje



Kodi	Përshkrimi	Cmimi
A806B8200B	Kapak bideje	-

Roca-Lavaman



Kodi	Përshkrimi	Cmimi
A3270B8000	Lavaman	-

Panele Dielllore

Ngrohje & Ftohje

Hidraulike

Hidrosanitare

Aksesore të ndryshëm

Koleksioni, me 3 dizajne të rrumbullakëta ,me kënde të buta dhe katrore , të cilat mund të kombinohen në mënyrë perfekte, do t'i japin jetë hapësirave të banjove në çdo stil.



Tre forma,
kombinime të
shumta, shumë
mundësi.



Kombinim i
porcelanit qelqor
dhe drurit.



Roca
SERIA INSPIRA

Roca – Wc



Kodi	Përshkrimi	Cmimi
A342528000	Wc	-

Roca – WC



Kodi	Përshkrimi	Cmimi
A342537000	Wc	-

Roca - Wc



Kodi	Përshkrimi	Cmimi
A342527000	Wc	-

Roca - Wc



Kodi	Përshkrimi	Cmimi
A346527000	Wc	-

Roca - Wc



Kodi	Përshkrimi	Cmimi
A347527000	Wc	-

Roca - Bide



Kodi	Përshkrimi	Cmimi
A357525000	Bide	-

Roca- Kase Wc-je



Kodi	Përshkrimi	Cmimi
A341520000	Kase Wc-je	-

Roca- Kapak bideje



Kodi	Përshkrimi	Cmimi
A80652200B	Kapak bideje	-

Roca- Kapak Wc-je



Kodi	Përshkrimi	Cmimi
A80153200B	Kapak Wc-je	-

Roca-Kapak Wc-je



Kodi	Përshkrimi	Cmimi
A80152C00B	Kapak Wc-je	-

Roca-Kapak Wc-je



Kodi	Përshkrimi	Cmimi
A80152200B	Kapak Wc-je	-

Panele Diellore

Ngrohje & Ftohje

Hidraulike

Hidrosanitare

Aksesore të ndryshëm

Roca-Lavaman



Roca- Lavaman



Roca-Lavaman



Panele Diellore

Ngrohje & Ftohje

Hidraulike

Hidrosanitare

Aksesore të ndryshëm

Kodi	Përshkrimi	Cmimi
A327502000	370x370x140mm	-
A32750R000	370x370x159mm	-
A327500000	500x370x140mm	-

Kodi	Përshkrimi	Cmimi
A327520000	500x370x140mm	-
A327523000	370x370x140mm	-
A327530000	370x370x140mm	-

Kodi	Përshkrimi	Cmimi
A32752R000	370x370x75mm	-
A327527000	550x370x75mm	-

Roca-Lavaman



Roca-Lavaman



Kodi	Përshkrimi	Cmimi
A32753R000	370x370x75mm	-

Kodi	Përshkrimi	Cmimi
A327534000	55x37 mm	-

Thjeshtësi dhe shkathtësi totale në një koleksion praktik, modern dhe të adaptueshëm.



Panele Dielllore

Ngrohje & Ftohje

Hidraulike

Hidrosanitare

Aksesore të ndryshëm

SERIA MERIDIAN

Roca - Wc



Kodi	Përshkrimi	Cmimi
A342247000	Wc	-

Roca- WC



Kodi	Përshkrimi	Cmimi
A342248000	Wc	-

Roca- Wc



Kodi	Përshkrimi	Cmimi
A347247000	Wc	-

Roca - Bide



Kodi	Përshkrimi	Cmimi
A357244000	Bide	-

Roca - Kaset Wc-je



Kodi	Përshkrimi	Cmimi
A341242000	Kasete 4.5/3L	-
A341240000	Kasete A31+D2D	-

Roca- Kapak Wc-je



Kodi	Përshkrimi	Cmimi
A8012A2004	Kapak Wc-je	-

Roca- Kapak bideje



Kodi	Përshkrimi	Cmimi
A8062A0004	Kapak bideje	-
A8062A2004	Kapak bideje	-

Roca- Kapak wc-je



Kodi	Përshkrimi	Cmimi
A8012AC004	Kapak wc-je	-

Roca- Kapak Wc-je



Kodi	Përshkrimi	Cmimi
A8012A200B	Kapak wc-je	-
A8012AC00B	Kapak wc-je	-

Roca- Lavaman



Kodi	Përshkrimi	Cmimi
A32724T000	Lavaman 600x320x130mm	-

Roca- Kollone lavamani



Kodi	Përshkrimi	Cmimi
A337240000	Kollon Lavamani	-

Roca- Gjysem Kollone lavamani



Kodi	Përshkrimi	Cmimi
A337241000	Gjysem kollone 240x290x300mm	-

Panele Diellore

Ngrohje & Ftohje

Hidraulike

Hidrosanitare

Aksesore të ndryshëm

Roca
SERIA MERIDIAN

Roca- WC inkaso



Roca- Bide Inkaso



Roca-Lavaman



Kodi	Përshkrimi	Cmimi
A34624L000	Wc Inkaso	-

Kodi	Përshkrimi	Cmimi
A357245000	Bide inkaso	-

Kodi	Përshkrimi	Cmimi
A327241000	Lavaman 650 X 460 inkaso	-

Roca- Lavaman



Kodi	Përshkrimi	Cmimi
A327243000	Lavaman 550 X 460 inkaso	-

Panele Dielllore

Ngrohje & Ftohje

Hidraulike

Hidrosanitare

Aksesore të ndryshëm

Format e pastra janë lënë pas, ndërsa trapezi dhe këndet e anasjellta plot karakter delikate janë fituesit në këtë koleksion të lehtë për t'u kombinuar, pavarësisht nga stili apo madhësia e hapësirës së banjës tuaj.



Roca
SERIA GAP

Roca-WC



Kodi	Përshkrimi	Cmimi
A342477000	WC DA monoblok	-
A342478000	WC DP monoblok	-

Roca-Gap WC



Kodi	Përshkrimi	Cmimi
A34273700H	WC 600 CC BTW PAN 4/2L	-

Roca- Bide



Kodi	Përshkrimi	Cmimi
A357474000	Bide	-

Roca – Kasete Wc-je



Kodi	Përshkrimi	Cmimi
A341470000	Kasete wc-je 3/8"	-

Roca – Kasete Wc-je



Kodi	Përshkrimi	Cmimi
A341731000	Kasete wc-je 3/8"	-

Roca- Kapak Wc-je



Kodi	Përshkrimi	Cmimi
A801472004	Kapak wc-je	-

Roca-Kapak Bideje



Kodi	Përshkrimi	Cmimi
A806472004	Kapak bideje	-

Roca- Kapak wc-je/bideje



Kodi	Përshkrimi	Cmimi
A801732004	Kapak wc-je/bideje	-

Roca-Kapak Wc-je



Kodi	Përshkrimi	Cmimi
A801482211	Kapak Wc-je	-

Roca- Kapak Wc-je



Kodi	Përshkrimi	Cmimi
A801472003	Kapak wc-je	-

Panele Diellore

Ngrohje & Ftohje

Hidraulike

Hidrosanitare

Aksesore të ndryshëm

SERIA GAP

Roca- WC Inkaso



Kodi	Përshkrimi	Cmimi
A34647L000	Wc inkaso	-

Roca-WC Inkaso



Kodi	Përshkrimi	Cmimi
A3460NL000	Wc inkaso	-

Roca - WC inkaso



Kodi	Përshkrimi	Cmimi
A346477000	Wc inkaso	-

Roca- Bide inkaso



Kodi	Përshkrimi	Cmimi
A3570N6000	Bide inkaso	-

Roca- Bide inkaso



Kodi	Përshkrimi	Cmimi
A357476000	Bide inkaso	-

Roca- Bide inkaso



Kodi	Përshkrimi	Cmimi
A357475000	Bide inkaso	-

Roca- Lavaman inkaso



Kodi	Përshkrimi	Cmimi
A327473000	Lavaman inkaso 650 X 470	-

Roca- Lavaman inkaso



Kodi	Përshkrimi	Cmimi
A32747R000	Lavaman inkaso 480 X 480	-

Roca- Gjysem Kollone lavamani



Kodi	Përshkrimi	Cmimi
A337471000	Gjysem Kollone lavamani	-

Panele Diellore

Ngrohje & Ftohje

Hidraulike

Hidrosanitare

Aksesore të ndryshëm

Me një të kaluar të tashme, ROCA vazhdon rrugën e saj drejt së ardhmes. Tradita, ekspertiza dhe pasioni që njerëzit të vazhdojnë të jenë pranë tyre në rutinën e tyre të përditshme, gjatë gjithë jetës së tyre.



Panele Dielllore

Ngrohje & Ftohje

Hidraulike

Hidrosanitare

Aksesore të ndryshëm

Roca
SERIA NEXO

Roca- WC



Kodi	Përshkrimi	Cmimi
A342640000	WC 375x665x750mm	-

Roca- WC



Kodi	Përshkrimi	Cmimi
A347615000	WC	-

Roca- Bide



Kodi	Përshkrimi	Cmimi
A357640000	Bide	-

Roca-Kaset Wc-je



Kodi	Përshkrimi	Cmimi
A341640000	Kasete Wc-je3/6 L	-

Roca-Kapak Wc-je



Kodi	Përshkrimi	Cmimi
A80164A004	Kapak wc-je	-

Roca- Kapak Bideje



Kodi	Përshkrimi	Cmimi
A806640004	Kapak bideje	-

Roca-Kapak WC-je



Kodi	Përshkrimi	Cmimi
A801C4200U	Kapak wc-je	-

Roca- Kapak wc-je/bideje



Kodi	Përshkrimi	Cmimi
A801640004	Kapak wc-je/bideje	-

Roca - Lavaman



Kodi	Përshkrimi	Cmimi
A327641000	Lavaman 600x475	-

Panele Diellore

Ngrohje & Ftohje

Hidraulike

Hidrosanitare

Aksesore të ndryshëm

Roca
SERIA NEXO

Roca- Lavaman



Kodi	Përshkrimi	Cmimi
A327642000	Lavaman 550	-

Roca- Kollone lavamani



Kodi	Përshkrimi	Cmimi
A337641000	Kollone lavamani	-

Roca-Gjysem Kollone lavamani



Kodi	Përshkrimi	Cmimi
A337642000	Gjysem kollone lavamani 170x290x340mm	-

Roca- WC Inkaso



Kodi	Përshkrimi	Cmimi
A34664L000	Wc inkaso	-

Roca- Bide Inkaso



Kodi	Përshkrimi	Cmimi
A357645000	Bide inkaso	-

Roca- Pishuar Inkaso



Kodi	Përshkrimi	Cmimi
A35364K000	Pishuar 310x280x490mm	-

Roca-WC inkaso



Kodi	Përshkrimi	Cmimi
A346640000	WC inkaso	-

Panele Diellore

Ngrohje & Ftohje

Hidraulike

Hidrosanitare

Aksesore të ndryshëm

Një përkushtim ndaj formave bazë dhe linjave të thjeshta me një prekje karakteri. Dizajni në shërbim të funksionalitetit në një koleksion vëllimesh kompakte që përshtatet lehtësisht.



Roca

SERIA DEBBA

Roca- WC



Roca- WC 655



Roca-Bide Inkaso



Kodi	Përshkrimi	Cmimi
A342998000	WC DP	-

Kodi	Përshkrimi	Cmimi
A342997000	WC 655 DA	-

Kodi	Përshkrimi	Cmimi
A355997000	Bide inkaso	-

Roca - Lavaman



Roca- Kollone Lavamani



Roca- Gjysem Kollone lavamani



Kodi	Përshkrimi	Cmimi
A32799M000	500x410 l bardhe	-
A325994000	600x480 i bardhe	-

Kodi	Përshkrimi	Cmimi
A335990000	Kollon lavamani	-

Kodi	Përshkrimi	Cmimi
A337991000	Gjysem kollone 200x290x325	-

Roca- Kaset wc-je



Roca - Kapak wc-je



Roca - Kapak Bideje



Kodi	Përshkrimi	Cmimi
A341990000	Kasete Wc-je 4.5/3L	-

Kodi	Përshkrimi	Cmimi
A8019D0004	Kapak Wc-je	-

Kodi	Përshkrimi	Cmimi
A8069D2004	Kapak Bideje	-

Roca- Kapak Wc-je



Kodi	Përshkrimi	Cmimi
A8019D2004	Kapak Wc-je	-

Panele Dielllore

Ngrohje & Ftohje

Hidraulike

Hidrosanitare

Aksesore të ndryshëm

Roca- WC Inkaso



Kodi	Përshkrimi	Cmimi
A347996000	Wc inkaso	-

Roca- WC Inkaso



Kodi	Përshkrimi	Cmimi
A346997000	Wc inkaso	-

Roca- WC inkaso



Kodi	Përshkrimi	Cmimi
A34699L000	Wc inkaso	-

Roca- Bide inkaso



Kodi	Përshkrimi	Cmimi
A355995000	Bide inkaso	-

Roca- Lavaman inkaso



Kodi	Përshkrimi	Cmimi
A325995000	Lavaman inkaso 550x440 BSN 1TH 40	-

Roca - Lavaman inkaso



Kodi	Përshkrimi	Cmimi
A325997000	Lavaman inkaso 450X370	-

Roca- Lavaman inkaso



Kodi	Përshkrimi	Cmimi
A325999000	Lavaman 350X300	-

Carmen është një homenazh për një nga lavamanët më emblematikë të Rocal nga vitet '40, i cili rikthehet me një karakter të pastër vintage për t'u bërë një koleksion intensiv porcelani dhe koleksioni i mobiljeve me risitë më të fundit në dizajnimin e hapësirave të banjove

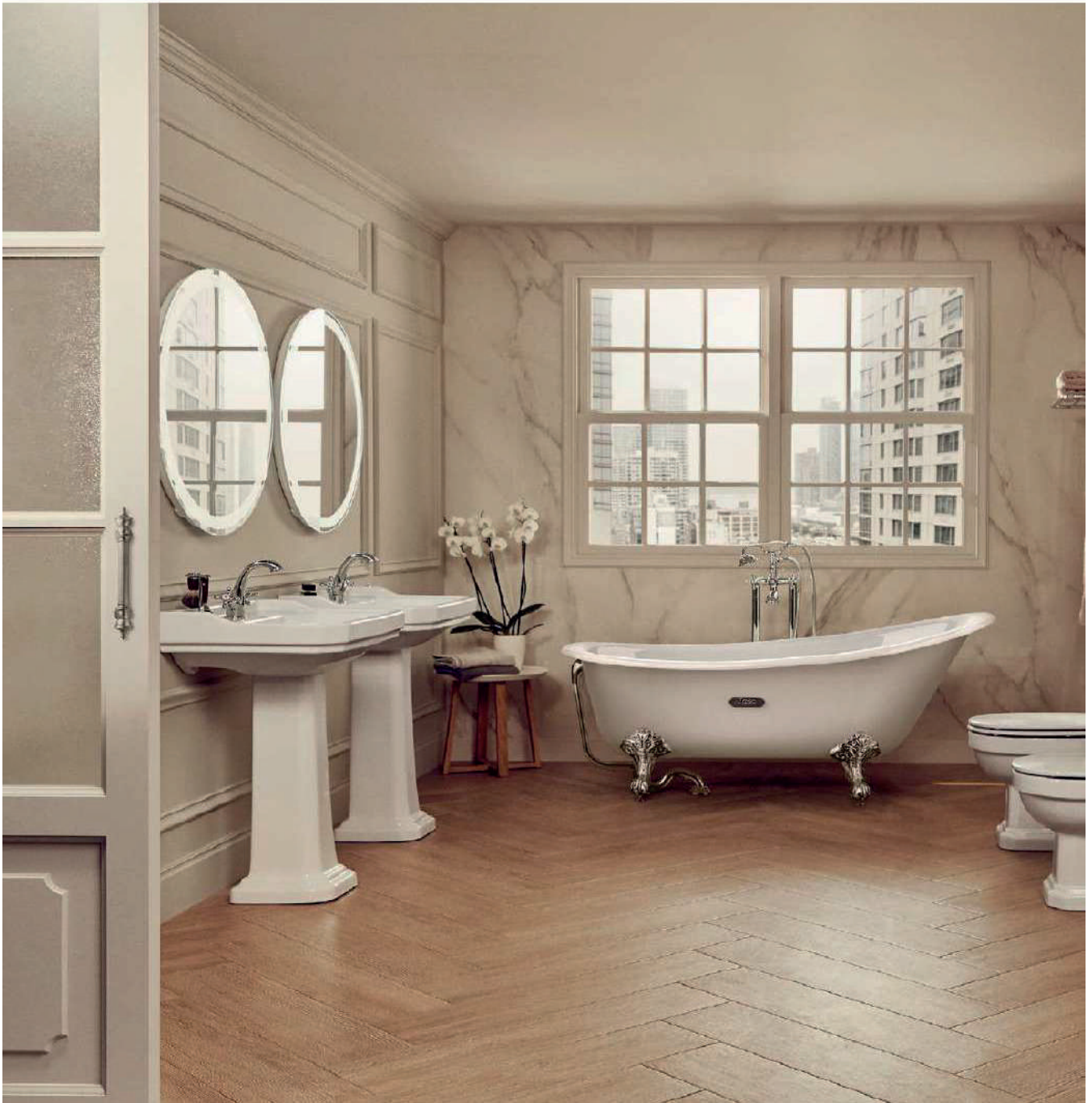

SERIA CARMEN

Roca-WC



Kodi	Përshkrimi	Cmimi
A3420A7000	Wc FS CC 67x37	-

Roca-Bide



Kodi	Përshkrimi	Cmimi
A3570A4000	Bide FS 560	-

Roca-Kaset Wc-je



Kodi	Përshkrimi	Cmimi
A3410A1000	Kasete wc-je 3//8	-

Roca-Kapak bideje



Kodi	Përshkrimi	Cmimi
A806B5000B	Kapak Bideje	-

Roca- Kapak WC



Kodi	Përshkrimi	Cmimi
A801B5200B	Kapak wc-je	-

Panele Diellore

Ngrohje & Ftohje

Hidraulike

Hidrosanitare

Aksesore të ndryshëm

Koleksioni Adele është për njerëzit që duan një organizim tradicional të hapësirës së banjës për të përmbushur nevojat e tyre të përditshme. Praktike dhe funksionale.



Roca

SERIA ADELE

Roca- Bide



Roca-Bide inkaso



Roca- WC



Panele Diellore

Ngrohje & Ftohje

Hidraulike

Hidrosanitare

Aksesore të ndryshëm

Kodi	Përshkrimi	Cmimi
A355195000	Bide	-

Kodi	Përshkrimi	Cmimi
A355198000	Bide inkaso	-

Kodi	Përshkrimi	Cmimi
A345196002	WC DP ,Kasete+kapak	-

Roca- WC



Roca- Wc



Roca-WC



Kodi	Përshkrimi	Cmimi
A34P195002	WC DA ,Kasete+kapak	-

Kodi	Përshkrimi	Cmimi
A34S196000	Wc DP	-

Kodi	Përshkrimi	Cmimi
A344196000	Wc DP me kaset plastike	-

Roca- Lavaman



Roca- Kapak Wc

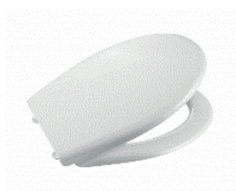

Kodi	Përshkrimi	Cmimi
A355195000	Lavaman 550x450	-

Kodi	Përshkrimi	Cmimi
A80129200P	Kapak Wc	-

Një klasik funksional që nuk do të dalë kurrë nga moda. Skicat e thjeshta dhe linjat dhe kthesat e lëmuara përcaktojnë një propozim që do të gjejë vendin e tij në çdo hapësirë të banjës .



Panele Dielllore

Ngrohje & Ftohje

Hidraulike

Hidrosanitare

Aksesore të ndryshëm

SERIA VICTORIA

Roca- WC



Kodi	Përshkrimi	Cmimi
A342394000	Wc DP	-

Roca-WC



Kodi	Përshkrimi	Cmimi
A342395000	WC DA	-

Roca-Kasete Wc-je



Kodi	Përshkrimi	Cmimi
A341392000	Kaset Wc-je 3/6 LT.	-

Roca-Bide



Kodi	Përshkrimi	Cmimi
A355394000	Bide	-

Roca-Bide inkaso



Kodi	Përshkrimi	Cmimi
A35530500S	Bide inkaso	-

Roca- Lavaman



Kodi	Përshkrimi	Cmimi
A325391000	Lavaman 65 X 51 cm	-

Roca- Lavaman



Kodi	Përshkrimi	Cmimi
A325393000	Lavaman 56 X 46 cm	-

Roca- Kollone lavamani



Kodi	Përshkrimi	Cmimi
A331300001	Kollon lavamani	-

Roca- Kapak Wc-je



Kodi	Përshkrimi	Cmimi
A801396005	Kapak Wc-je	-

Roca-Kapak bideje



Kodi	Përshkrimi	Cmimi
A806390004	Kapak bideje	-

Roca- Kapak Wc-je



Kodi	Përshkrimi	Cmimi
A801B6200B	Kapak wc-je LC S&C	-

Roca
ROCA PORCELANE

Roca-Lavaman incaso



Roca-Bide incaso



Roca-Pishuar



Kodi	Përshkrimi	Cmimi
WF101801001	Lavaman incaso Polo 52x40	-

Kodi	Përshkrimi	Cmimi
WM830012Z001001	Roca-Bide incaso Polo	-

Kodi	Përshkrimi	Cmimi
A3590J1000	Pishuar	-

Roca-Pishuar



Roca- Pishuar



Roca-Gjysem Kollone Lavamani



Kodi	Përshkrimi	Cmimi
A35945J000	Pishuar 325x330x560mm	-

Kodi	Përshkrimi	Cmimi
A3590J0000	Pishuar	-

Kodi	Përshkrimi	Cmimi
A336312005	Gjysem kollone lavamani	-

Roca-Lavaman



Roca-Lavaman



Roca-Lavaman inkaso



Kodi	Përshkrimi	Cmimi
TN10206400000001	Lavaman 56x44	-

Kodi	Përshkrimi	Cmimi
TN10206300000001	Lavaman 63x48	-

Kodi	Përshkrimi	Cmimi
A327225000	Lavaman 450x450x180	-

Roca-Lavaman inkaso



Roca-Lavaman



Kodi	Përshkrimi	Cmimi
A327876000	Lavaman 420x420x230mm	-

Kodi	Përshkrimi	Cmimi
A327532000	Lavaman 370x370x140	-

Panele Diellore

Ngrohje & Ftohje

Hidraulike

Hidrosanitare

Aksesore të ndryshëm

Roca- Grup bideje



Kodi	Përshkrimi	Cmimi
A5A6090C00	Grup bideje	-

Roca- Grup dushi



Kodi	Përshkrimi	Cmimi
A5A0290C00	Grup dushi	-

Roca- Grup dushi



Kodi	Përshkrimi	Cmimi
A5A2290C00	Grup dushi pa deviator	-

Roca- Grup dushi



Kodi	Përshkrimi	Cmimi
A5A0690C00	Grup dushi me deviator	-

Roca- Grup dushi



Kodi	Përshkrimi	Cmimi
A5A0890C00	Grup dushi me deviator	-

Roca- Grup lavamani



Kodi	Përshkrimi	Cmimi
A5A3090C00	Grup lavamani	-

Roca- Grup lavamani



Kodi	Përshkrimi	Cmimi
A5A3090C01	Grup lavamani	-

Roca- Grup lavamani



Kodi	Përshkrimi	Cmimi
A5A3790C00	Grup lavamani	-

Roca- Grup lavamani



Kodi	Përshkrimi	Cmimi
A5A3D90C00	Grup lavamani	-

Roca
ATLAS - CARMEN GRUPET

Roca-Grup dushi



Kodi	Përshkrimi	Cmimi
A5A2187C00	Grup dushi Atlas	-

Roca- Grup lavamani



Kodi	Përshkrimi	Cmimi
A5A3390C00	Grup lavamani Atlas	-

Roca-Grup dushi



Kodi	Përshkrimi	Cmimi
A5A2B90C00	Grup dushi pa deviator Atlas	-

Roca- Grup lavamani



Kodi	Përshkrimi	Cmimi
A5A3590C00	Grup lavamani Atlas	-

Roca-Grup bideje



Kodi	Përshkrimi	Cmimi
A5A6A4BC00	Grup bideje Carmen	-

Roca-Grup lavamani



Kodi	Përshkrimi	Cmimi
A5A3A4BC00	Grup lavamani Carmen	-

Roca-Grup Vaske



Kodi	Përshkrimi	Cmimi
A5A274BC00	Grup vaske Carmen	-

Panele Dielllore

Ngrohje & Ftohje

Hidraulike

Hidrosanitare

Aksesore të ndryshëm

AROLA GRUPET

Roca-Grup lavamani



Kodi	Përshkrimi	Cmimi
A5A306AC0K	Grup lavamani	-

Roca-Grup dushi



Kodi	Përshkrimi	Cmimi
A5A02DAC0K	Grup dushi	-

Roca-Grup dushi



Kodi	Përshkrimi	Cmimi
A5A236AC0K	Grup dushi pa deviator	-

Roca-Grup dushi



Kodi	Përshkrimi	Cmimi
A5A226AC0K	Grup dushi pa deviator	-

Roca-Grup bideje



Kodi	Përshkrimi	Cmimi
A5A606AC0K	Grup bideje	-

Roca-Grup dushi



Kodi	Përshkrimi	Cmimi
A5A016AC0K	Grup dushi	-

Roca-Grup dushi



Kodi	Përshkrimi	Cmimi
A5A0C6AC0K	Grup dushi Arola me deviator	-

Roca-Grup dushi



Kodi	Përshkrimi	Cmimi
A5A0B6AC0K	Grup dushi Arola	-

Roca-Grup bideje



Kodi	Përshkrimi	Cmimi
A5A626AC0K	Grup bideje Arola	-

Roca-Grup dushi



Kodi	Përshkrimi	Cmimi
A5A076AC0K	Grup dushi me deviator	-

Roca-Grup dushi



Kodi	Përshkrimi	Cmimi
A5A066AC0K	Grup dushi me deviator	-

Panele Diellore

Ngrohje & Ftohje

Hidraulike

Hidrosanitare

Aksesore të ndryshëm

Roca- Grup dushi



Kodi	Përshkrimi	Cmimi
A5A2125C00	Grup dushi	-

Roca - Grup lavapjate



Kodi	Përshkrimi	Cmimi
A5A8125C00	Grup lavapjate	-

Roca - Grup dushi



Kodi	Përshkrimi	Cmimi
A5A9718C00	Grup dushi salishent	-

Roca- Grup dushi



Kodi	Përshkrimi	Cmimi
A5B9961C00	Grup dushi salishent	-

Roca- Grup bideje



Kodi	Përshkrimi	Cmimi
A5A6025C00	Grup bideje	-

Roca - Grup lavamani



Kodi	Përshkrimi	Cmimi
A5A3025C00	Grup lavamani	-

Roca-Grup dushi



Kodi	Përshkrimi	Cmimi
A5A2018C00	Grup dushi salishent	-

Roca-Grup dushi



Kodi	Përshkrimi	Cmimi
A5A2718C00	Grup dushi salishent	-

Roca- Grup dushi



Kodi	Përshkrimi	Cmimi
A5A0225C00	Grup dushi	-

Roca - Grup lavamani



Kodi	Përshkrimi	Cmimi
A5A3E25C00	Grup lavamani	-

Roca-Grup dushi



Kodi	Përshkrimi	Cmimi
A5A9725C00	Grup dushi salishent	-

Roca-Grup dushi



Kodi	Përshkrimi	Cmimi
A5A0B11C00	Grup dushi me deviator lanta	-

Roca-Grup dushi



Kodi	Përshkrimi	Cmimi
A5A2B11C00	Grup dushi pa deviator lanta	-

Roca-Grup lavamani



Kodi	Përshkrimi	Cmimi
A5A3011C00	Grup lavamani lanta	-

Roca-Grup lavamani



Kodi	Përshkrimi	Cmimi
A5A3411C00	Grup lavamani lanta	-

Roca-Grup dushi



Kodi	Përshkrimi	Cmimi
A5A2111C00	Grup dushi lanta	-

Roca-Grup dushi



Kodi	Përshkrimi	Cmimi
A5A0211C00	Grup dushi lanta	-

Roca- Grup lavamani



Kodi	Përshkrimi	Cmimi
A5A3511C00	Grup lavamani lanta	-

Roca-Grup dushi



Kodi	Përshkrimi	Cmimi
A5A2298C00	Grup dushi pa deviator Monodin	-

Roca-Grup dushi



Kodi	Përshkrimi	Cmimi
A5A0698C00	Grup dushi me deviator Mondini	-

Roca-Grup dushi



Kodi	Përshkrimi	Cmimi
A5A0298C00	Grup dushi Mondini	-

Roca-Grup lavamani



Kodi	Përshkrimi	Cmimi
A5A3098C00	Grup lavamani	-

Roca
INSIGNIA - CORAL GRUPET

Roca-Grup dushi



Roca-Grup lavamani



Roca-Grup bideje



Kodi	Përshkrimi	Cmimi
A5A0B3AC00	Grup dushi me deviator Insignia	-

Kodi	Përshkrimi	Cmimi
A5A353AC00	Grup lavamani Insignia	-

Kodi	Përshkrimi	Cmimi
A5A603AC00	Grup bideje Insignia	-

Roca-Grup Lavaman



Roca-Grup lavamani



Roca-Grup lavapajte



Kodi	Përshkrimi	Cmimi
A5A323AC00	Roca-Lavaman Insignia	-

Kodi	Përshkrimi	Cmimi
A5A3087C00	Grup lavamani Coral	-

Kodi	Përshkrimi	Cmimi
A5A8487C00	Grup lavapajte Coral	-

Roca-Grup lavapjate



Roca-Grup dushi



Roca-Grup bideje



Kodi	Përshkrimi	Cmimi
A5A8A87C00	Grup lavapjate Coral	-

Kodi	Përshkrimi	Cmimi
A5A0287C00	Grup dushi Coral	-

Kodi	Përshkrimi	Cmimi
A5A6087C00	Grup bideje Coral	-

Panele Diellore

Ngrohje & Ftohje

Hidraulike

Hidrosanitare

Aksesore të ndryshëm

Roca
NAIA, MALVA, ANARA - GRUPET

Roca-Grup lavamani



Kodi	Përshkrimi	Cmimi
A5A3096C00	Grup lavamani Naia	-

Roca-Grup lavamani



Kodi	Përshkrimi	Cmimi
A5A3796C00	Grup lavamani i larte Naia	-

Roca-Grup bideje



Kodi	Përshkrimi	Cmimi
A5A6096C00	Grup bideje Naia	-

Roca-Grup dushi



Kodi	Përshkrimi	Cmimi
A5A0296C00	Grup dushi Naia	-

Roca-Grup dushi



Kodi	Përshkrimi	Cmimi
A5A2196C00	Grup dushi Naia	-

Roca-Grup dushi



Kodi	Përshkrimi	Cmimi
A5A0B96C00	Grup dushi me deviator Naia	-

Roca-Grup dushi inkaso Naia



Kodi	Përshkrimi	Cmimi
A5A2B96C00	Grup dushi pa deviator Naia	-

Roca-Grup lavamani



Kodi	Përshkrimi	Cmimi
A5A3596C00	Grup lavamani Naia	-

Roca-Grup dushi



Kodi	Përshkrimi	Cmimi
A5A223BC00	Grup dushi pa deviator Malva	-

Roca-Grup bideje



Kodi	Përshkrimi	Cmimi
A5A603BC00	Grup bideje Malva	-

Roca- Grup lavamani



Kodi	Përshkrimi	Cmimi
A5A3L09C00	Grup lavamani L20 / A525220603	-

Roca-Grup lavamani



Kodi	Përshkrimi	Cmimi
A5A3A1BC0K	Grup lavamani Anara	-

Roca
GRUPE DUSHI

Roca-Grup lavamani



Kodi	Përshkrimi	Cmimi
A5A353ACN0	Grup lavamani I zi	-

Roca-Grup lavamani



Kodi	Përshkrimi	Cmimi
A5A3036C00	Grup lavamani	-

Roca- Grup lavamani



Kodi	Përshkrimi	Cmimi
A525220603	Grup lavamani me deviator	-

Roca-Grup Lavamani



Kodi	Përshkrimi	Cmimi
A5A5709C00	Grup Lavamani me sensor	-

Roca-Grup dushi inkaso me telefon



Kodi	Përshkrimi	Cmimi
A5B9361C00	Grup dushi inkaso me telefon	-

Roca-Grup dushi



Kodi	Përshkrimi	Cmimi
A5A1318C00	Grup dushi	-

Roca-Grup dushi



Kodi	Përshkrimi	Cmimi
A5A1409C00	Grup dushi	-

Roca-Grup dushi



Kodi	Përshkrimi	Cmimi
A5A1209C00	Grup dushi	-

Roca-Grup dushi



Kodi	Përshkrimi	Cmimi
A5A0C88C00	Grup dushi me deviator	-

Roca-Grup dushi



Kodi	Përshkrimi	Cmimi
A5A2A18C00	Grup dushi me deviator	-

Roca-Grup dushi



Kodi	Përshkrimi	Cmimi
A5A2B18C00	Grup dushi me deviator	-

Roca-Set grup lavamani+dushi+aksessore



Kodi	Përshkrimi	Cmimi
A5D057AC0K	Set grup lavamani+dushi+aksessore	-

Panele Diellore

Ngrohje & Ftohje

Hidraulike

Hidrosanitare

Aksessore të ndryshëm

ROCA – GRUPE DUSHI, SALISHENT

Roca-grup dushi



Kodi	Përshkrimi	Cmimi
A5A0B7AC0K	Grup dushi me deviator Saona	-

Roca-grup dushi



Kodi	Përshkrimi	Cmimi
A5A0C7AC0K	Grup dushi me deviator Saona	-

Roca-grup dushi



Kodi	Përshkrimi	Cmimi
A5A2C7AC0K	Grup dushi pa deviator Saona	-

Roca-grup dushi



Kodi	Përshkrimi	Cmimi
A5A2B7AC0K	Grup dushi pa deviator Saona	-

Roca-Grup dushi



Kodi	Përshkrimi	Cmimi
A5A2B3ACN0	Grup dushi pa deviator i zi	-

Roca-Grup dushi



Kodi	Përshkrimi	Cmimi
A5A0B3ACN0	Grup dushi me deviator i zi	-

Roca- Salishent



Kodi	Përshkrimi	Cmimi
A5B0305C00	Salishent 900	-

Roca-Set salishent



Kodi	Përshkrimi	Cmimi
A5B1408C00	Set salishent i kompletuar pa grup dushi 130 4F	-

Roca-Set salishent



Kodi	Përshkrimi	Cmimi
A5B9407C00	Set salishent i kompletuar pa grup dushi	-

Roca- Set salishent



Kodi	Përshkrimi	Cmimi
A5B9403C00	Set salishent i kompletuar pa grup dushi 80/1	-

Roca-Kit me koke dushi



Kodi	Përshkrimi	Cmimi
A5B1407C00	Kit me koke dushi te rumbullaket 130 4F	-

Roca
ROCA – GRUPE DUSHI, SALISHENT

Roca- Grup dushi hidromasazh



Kodi	Përshkrimi	Cmimi
A2H0416000	Salishent me hidromasazh	-

Roca-Grup dushi hidromasazh



Kodi	Përshkrimi	Cmimi
A2H0423000	Grup dushi me hidromasazh +koke termostatike+deviator	-

Roca- Grup dushi + kollon



Kodi	Përshkrimi	Cmimi
A5A9B90C00	Grup dushi +kollon	-

Roca-Grup dushi +kollon



Roca-Grup dushi + kollon



Roca-Grup dushi+kollon



Kodi	Përshkrimi	Cmimi
A5A2080C00	Grup dushi +kollon	-

Roca-Salishent



Kodi	Përshkrimi	Cmimi
A5A9780C00	Grup dushi +kollon	-

Roca- Salishent



Kodi	Përshkrimi	Cmimi
A5A9790C00	Grup dushi+kollon	-

Roca- Salishent



Kodi	Përshkrimi	Cmimi
A5B9408C00	Salishent i kompletuar pa grup dushi 130/2	-

Kodi	Përshkrimi	Cmimi
A5B9D03C00	Salishent i kompletuar pa grup Stella -100/1	-

Kodi	Përshkrimi	Cmimi
A5B1403C00	Salishent i kompletuar pa grup dushi 80/3	-

Panele Diellore

Ngrohje & Ftohje

Hidraulike

Hidrosanitare

Aksesore të ndryshëm

Roca-Koke dushi



Kodi	Përshkrimi	Cmimi
A5B2350C00	Koke dushi katrore 200x200mm rain	-

Roca-Koke dushi



Kodi	Përshkrimi	Cmimi
A5B2150C00	Koke dushi e rrumbullaket 200mm	-

Roca-Koke dushi



Kodi	Përshkrimi	Cmimi
A5B2550C00	Koke dushi e rrumbullaket 300mm	-

Roca-Koke dushi



Kodi	Përshkrimi	Cmimi
A5B2450C00	Koke dushi katrore 250x250mm	-

Roca-Koke dushi



Kodi	Përshkrimi	Cmimi
A5B2750C00	Koke dushi katrore 300x300mm	-

Roca-Koke dushi



Kodi	Përshkrimi	Cmimi
A5B3050C00	Koke dushi katrore 360x240mm	-

Roca- Koke dushi



Kodi	Përshkrimi	Cmimi
A5B2950C00	Koke dushi e rrumbullaket 200mm	-

Roca-Koke dushi



Kodi	Përshkrimi	Cmimi
A5B2650C00	Koke dushi e rrumbullaket 400mm	-

Roca- Koke dushi



Kodi	Përshkrimi	Cmimi
A5B2850C00	Koke dushi katrore 400x400mm	-

Roca- Koke dushi



Kodi	Përshkrimi	Cmimi
A5B2250C00	Koke dushi e rrumbullaket 250mm ABS	-

Roca- Koke dushi



Kodi	Përshkrimi	Cmimi
A5A9978C00	Koke dushi Puzzle	-

Roca- Koke dushi



Kodi	Përshkrimi	Cmimi
A5A9878C00	Koke dushi Puzzle 260x500x32 mm	-

Roca-Koke dushi



Kodi	Përshkrimi	Cmimi
A5B6661C00	Koke dushi Fit Vandal	-

Roca- Koke dushi



Kodi	Përshkrimi	Cmimi
A5B4050C00	Koke dushi 300x300mm katrore e zeze	-

Roca-Koke dushi



Kodi	Përshkrimi	Cmimi
A5B3950C00	Koke dushi 300mm e rrumbullaket e zeze	-

Roca
ROCA - KOKE DUSHI

Roca- Koke dushi



Kodi	Përshkrimi	Cmimi
A5B9107C00	Koke dushi me 2 funksione, Sensum	-

Roca- Koke dushi



Kodi	Përshkrimi	Cmimi
A5B1108C00	Koke dushi me 4 funksione fi 130 mm , Sensum Square	-

Roca- Koke dushi



Kodi	Përshkrimi	Cmimi
A5B1107C00	Koke dushi me 4 funksione , Sensum Round	-

Roca-Koke dushi



Kodi	Përshkrimi	Cmimi
A5B1B03C00	Koke dushi me 3 funksione	-

Roca-Koke dushi



Kodi	Përshkrimi	Cmimi
A5B9B03C00	Koke dushi 100 1F,40x105x265mm	-

Roca- Koke dushi



Kodi	Përshkrimi	Cmimi
A5B9108C00	Koke dushi e rrumbullaket 130mm me 2 funksione	-

Roca-Koke dushi



Kodi	Përshkrimi	Cmimi
A5B1103C00	Koke dushi D80 me 3 funksione	-

Roca-Koke dushi



Kodi	Përshkrimi	Cmimi
AG0082700R	Koke dushi Natura	-

Roca-Koke dushi



Kodi	Përshkrimi	Cmimi
A5B9103C00	Koke dushi e rrumbullaket D80	-

Roca- Koke dushi



Kodi	Përshkrimi	Cmimi
A5B9L61C00	Koke dushi katrore 228x25mm	-

Roca- Koke dushi



Kodi	Përshkrimi	Cmimi
A5B9B61C00	Koke dushi e rrumbullaket 198x25mm	-

Roca- Koke dushi



Kodi	Përshkrimi	Cmimi
A505319400	Koke dushi	-

Roca- Koke dushi



Kodi	Përshkrimi	Cmimi
A5B1110C00	Koke dushi katrore fi 140 mm , Plenum Square	-

Roca- Koke dushi



Kodi	Përshkrimi	Cmimi
A5B1111C00	Koke dushi me 3 funksione , Plenum Round	-

Roca-Koke dushi



Kodi	Përshkrimi	Cmimi
A5BH103C00	Koke dushi	-

Panele Diellore

Ngrohje & Ftohje

Hidraulike

Hidrosanitare

Aksesore të ndryshëm

Roca

KOKE DUSHI

Roca-Kit me koke dushi



Roca-Kit me koke dushi



Roca-Koke dushi



Kodi	Përshkrimi	Cmimi
A5B1308C00	Kit me koke dushi 1.7 m	-

Kodi	Përshkrimi	Cmimi
A5B1307C00	Kit me koke dushi te rrumbullaket 1.7m	-

Kodi	Përshkrimi	Cmimi
A5B1C03C00	Koke dushi set 100 3F	-

Roca-Koke dushi



Roca- Mbajtese + telefon



Roca-Koke dushi



Kodi	Përshkrimi	Cmimi
A5B9130C00	Koke dushi per pishuar, Be Fresh	-

Kodi	Përshkrimi	Cmimi
A5B9230C00	Mbajtese + telefon Be Fresh	-

Kodi	Përshkrimi	Cmimi
A5B3750CN0	Koke dushi tatinium e zeze	-

Panele Diellore

Ngrohje & Ftohje

Hidraulike

Hidrosanitare

Aksesore të ndryshëm

Roca
GRUPE LAVAPJATE

Roca-Grup lavapjate



Kodi	Përshkrimi	Cmimi
A5A8460C00	Grup lavapjate Targa	-

Roca-Grup lavapjate



Kodi	Përshkrimi	Cmimi
A5A8560C00	Grup lavapjate Targa	-

Roca-Grup lavapjate



Kodi	Përshkrimi	Cmimi
A5A8160C00	Grup lavapjate Targa	-

Roca-Grup lavapjate



Kodi	Përshkrimi	Cmimi
A5A8360C00	Grup lavapjate Targa	-

Roca-Grup lavapjate



Kodi	Përshkrimi	Cmimi
A5A841BC0K	Grup lavapjate Anara	-

Roca-Grup lavapjate



Kodi	Përshkrimi	Cmimi
A5A846AC0K	Grup lavapjate	-

Roca-Grup lavapjate



Kodi	Përshkrimi	Cmimi
A5A7409B00	Grup lavapjate i bardhe Mencia	-

Roca-Grup lavapjate



Kodi	Përshkrimi	Cmimi
A5A7409C00	Grup lavapjate Mencia	-

Roca-Grup lavapjate



Kodi	Përshkrimi	Cmimi
A5A7409CM0	Grup lavapjate gri Mencia	-

Roca-Grup lavapjate



Kodi	Përshkrimi	Cmimi
A5A8209C00	Roca-Grup lavapjate L20	-

Roca-Grup lavapjate



Kodi	Përshkrimi	Cmimi
A5A7409CN0	Grup lavapjate i zi Mencia	-

Panele Diellore

Ngrohje & Ftohje

Hidraulike

Hidrosanitare

Aksesore të ndryshëm



ROCA – PLLAKE DUSHI

Roca-Pllake dushi e bardhe, R ITALIA



Kodi	Përshkrimi	Cmimi
A374772001	800X800x10	-
A374771001	900X900x10	-

Roca-Pllake dushi porcelani



Kodi	Përshkrimi	Cmimi
A374772000	800x800x100	-
A374771000	900x900x100	-

Roca-Pllake dushi e bardhe, R ITALIA



Kodi	Përshkrimi	Cmimi
A374775001	800X800x10	-
A374774001	900X900x10	-

Roca-Pllake dushi e bardhe, ITALIA



Kodi	Përshkrimi	Cmimi
A37477A001	1200X800x10	-
A37477C001	1000X800x10	-

Panele Diellore

Ngrohje & Ftohje

Hidraulike

Hidrosanitare

Aksesore të ndryshëm

Roca
ROCA - VASKA

Roca-Vaske



Kodi	Përshkrimi	Cmimi
A248158001	Vaske 1800x800x580mm	-

Roca-Vaske



Kodi	Përshkrimi	Cmimi
A248189000	Vaske harkore 1350x1350x545mm	-

Roca-Vaske



Kodi	Përshkrimi	Cmimi
A248159001	Vaske ovale 1850x1000x420mm	-

Roca-Vaske



Kodi	Përshkrimi	Cmimi
A220950001	Vaske PRINCESS 1700x700x430mm	-

Roca-Vaske



Kodi	Përshkrimi	Cmimi
A248165000	Vaske 1500x1000x420mm	-

Roca-Vaske



Kodi	Përshkrimi	Cmimi
A259853000	Vaske 1500mm	-

Roca-Vaske



Kodi	Përshkrimi	Cmimi
A235960000	Vaske Contesa 1600x700x400	-

Roca-Vaske



Kodi	Përshkrimi	Cmimi
A247701000	Vaske Vythos 1700x800	-

Roca- Vaske



Kodi	Përshkrimi	Cmimi
A233650003	Vaske ovale 1700x850	-

Roca-Mbeshtetes koke



Kodi	Përshkrimi	Cmimi
A291066000	Mbeshtetes koke vaske	-

Roca-Kapak perforcues



Kodi	Përshkrimi	Cmimi
A259830000	Kapak perforcues vaske	-

Roca- kapak harkor



Kodi	Përshkrimi	Cmimi
A259861000	kapak harkor vaske	-

Panele Diellore

Ngrohje & Ftohje

Hidraulike

Hidrosanitare

Aksesore të ndryshëm

ROCA- GABINE DUSHI VICTORIA

Roca- Gabine dushi



Roca- Gabine dushi harkore



Roca-Gabine dushi katrore



Panele Dielllore

Ngrohje & Ftohje

Hidraulike

Hidrosanitare

Aksesore të ndryshëm

Kodi	Përshkrimi	Cmimi
AM176C0012	2L2 1000x800x1900	-

Kodi	Përshkrimi	Cmimi
AM17708012	MR(500) 800X800X1900	-
AM17809012	MR(550) 900X900X1900	-

Kodi	Përshkrimi	Cmimi
AM17608012	2L2 800X800X1900	-
AM17609012	2L2 900X900X1900	-

Roca-Gabine dushi



Kodi	Përshkrimi	Cmimi
AM176C2012	2L2 1200X800X1900	-

Roca- Pasqyre



Kodi	Përshkrimi	Cmimi
A812329406	Pasqyre Victoria 1000mm	-

Roca- Mobilje banjo



Kodi	Përshkrimi	Cmimi
A855832153	Mobilje banjo Victoria gri -N 800x460x565 (856670153)	-

Roca- Mobilje banjo



Kodi	Përshkrimi	Cmimi
A855842153	Mobilje banjo Victoria +lavaman+pasqyre Led 800x460x565 N	-

Panele Dielllore

Ngrohje & Ftohje

Hidraulike

Hidrosanitare

Aksesore të ndryshëm

Roca- Mobilje banjo



Kodi	Përshkrimi	Cmimi
A855852423	Mobilje banjo Victoria 800x450x565 Unik	-

Roca- Mobilje banjo



Kodi	Përshkrimi	Cmimi
A855857201	Mobilje banjo Victoria +lavaman+pasqyre Led 800x460x565 N	-

Roca- Mobilje banjo



Kodi	Përshkrimi	Cmimi
A855952322	Mobilje banjo Prisma 80 cm	-

Roca- Mobilje banjo



Kodi	Përshkrimi	Cmimi
A855968153	Mobilje banjo Debba 80 cm,e zeze	-

Roca- Pasqyre

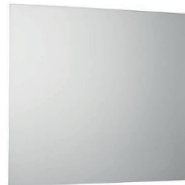

Kodi	Përshkrimi	Cmimi
A812199000	Pasqyre Debba 1000x900mm	-

Roca- Mobilje banjo



Kodi	Përshkrimi	Cmimi
A855998150	Mobilje banjo Gap 80cm,kafe	-

Roca- Mobilje banjo



Roca- Pasqyre



Kodi	Përshkrimi	Cmimi
A851369415	Mobilje banjo Carmen 800mm	-

Kodi	Përshkrimi	Cmimi
A812194000	Pasqyre Luna e rrumbullaket 750x28x750mm	-

ROCA-BUTON KASETE

Roca-Buton kasete



Roca-Buton kasete



Roca-Buton Kasete



Panele Diellore

Ngrohje & Ftohje

Kodi	Përshkrimi	Cmimi
A890089000	Buton kasete PL 10 DUAL i bardhe	-

Kodi	Përshkrimi	Cmimi
A890089206	Buton kasete PL 10 DUAL ,i zi mat	-

Kodi	Përshkrimi	Cmimi
A890099000	Buton Kasete PL5 DUAL I Bardhe	-

Roca-Buton kasete



Roca-Buton kasete



Roca- Kasete + buton



Hidraulike

Kodi	Përshkrimi	Cmimi
A890099001	Buton Kasete PL5 DUAL i kromuar	-

Kodi	Përshkrimi	Cmimi
A890102009	Buton kasete EP1 xham, i bardhe me touch	-

Kodi	Përshkrimi	Cmimi
A89P06002E	Kaset+buton i rumbullaket i kromuar	-

Roca- Kasete + buton

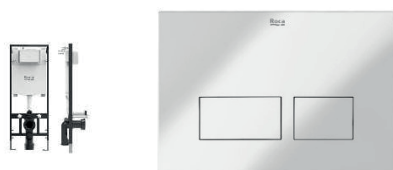

Roca- Kasete + buton



Roca- Kasete + buton



Hidrosanitare

Kodi	Përshkrimi	Cmimi
A89P16002E	Kasete + buton katror i kromuar, Now model	-

Kodi	Përshkrimi	Cmimi
A89P76002E	Kasete + buton i rumbullaket i bardhe, Now model	-

Kodi	Përshkrimi	Cmimi
A89P86002E	Kasete + buton katror i bardhe, Now model	-

Aksesore të ndryshëm

Roca-Kasete



Roca-Kasete



Roca-Kasete



Kodi	Përshkrimi	Cmimi
A890090020	Kasete Duplo me konstruktion te plote blu (DN90 + DN100)	-

Kodi	Përshkrimi	Cmimi
A890080120	Kasete Basic Compact me gjysem konstruktion 8cm (DN90 + DN100)	-

Kodi	Përshkrimi	Cmimi
A890080020	Kasete Duplo Compact me konstruktion te plote 8cm blu (DN90 + DN100)	-

Roca-Kasete



Roca-Kasete



Roca-Kasete



Kodi	Përshkrimi	Cmimi
A89011010B	Kasete me gjysem konstruktion 12cm (DN90)	-

Kodi	Përshkrimi	Cmimi
A89011001B	Kasete me konstruktion te plote e zeze (DN100)	-

Kodi	Përshkrimi	Cmimi
A890091200	Kasete me konstruktion te plote 1120mm blu per bide	-

Roca-Kasete



Roca-Kasete



Kodi	Përshkrimi	Cmimi
A890093000	Kasete me konstruktion te plote 1120mm blu per lavaman	-

Kodi	Përshkrimi	Cmimi
A890094100	Kasete me konstruktion te plote 1320mm blu per pishuar	-

Roca
ROCA - BUTON KASETE

Roca-Buton kasete



Kodi	Përshkrimi	Cmimi
A890089005	Buton kasete PL10 Dual Combi	-

Roca-Buton kasete



Kodi	Përshkrimi	Cmimi
A890089002	Buton kasete PL 10 DUAL Gri	-

Roca-Buton kasete



Kodi	Përshkrimi	Cmimi
A890096000	Buton kasete PL2 DUAL i bardhe	-

Roca-Buton Kasete



Kodi	Përshkrimi	Cmimi
A890099002	Buton Kasete PL 5 DUAL Gri	-

Roca-Buton kasete



Kodi	Përshkrimi	Cmimi
A890096005	DUAL i bardhe mate	-

Roca-Buton kasete



Kodi	Përshkrimi	Cmimi
A890098005	Buton kasete PL 4 Dual Combi	-

Roca-Buton kasete

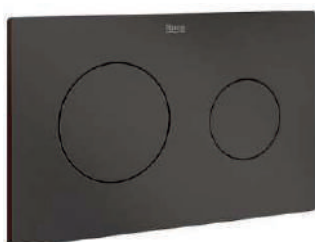

Kodi	Përshkrimi	Cmimi
A89008920M	Buton kasete PL 10 DUAL kafe mate	-

Roca-Buton kasete



Kodi	Përshkrimi	Cmimi
A890098001	Buton kasete PL 4 mat i kromuar	-

Roca-Buton kasete



Kodi	Përshkrimi	Cmimi
A890097004	Buton kasete PL3 DUAL inoks	-

Roca-Buton kasete



Kodi	Përshkrimi	Cmimi
A890089001	Buton kasete PL 10 DUAL i kromuar	-

Roca-Buton kasete



Kodi	Përshkrimi	Cmimi
A890102008	Buton kasete EP1 xham i zi me touch	-

Roca-Buton kasete



Kodi	Përshkrimi	Cmimi
A890089207	Buton kasete PL 10 DUAL i bardhe mate	-

Roca-Buton kasete

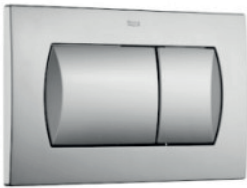

Kodi	Përshkrimi	Cmimi
A8901160B2	Buton kasete 62B DUAL Gri	-

Roca-Buton kasete

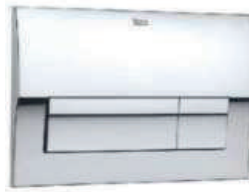

Kodi	Përshkrimi	Cmimi
A8901170B0	Buton kasete B01 DUAL I bardhe	-
A8901170B2	Buton kasete B01 DUAL Gri	-

Roca-Buton kasete



Kodi	Përshkrimi	Cmimi
A8901170B1	Buton kasete B01 DUAL I kromuar	-

Roca-Buton kasete



Kodi	Përshkrimi	Cmimi
A890088206	Buton kasete PL 7 mat i zi	-

Roca-Buton kasete



Kodi	Përshkrimi	Cmimi
A8901150B0	Buton kasete 52B DUAL i bardhe	-

Roca-Buton kasete



Kodi	Përshkrimi	Cmimi
A8901150B1	Buton kasete 52B DUAL I kromuar	-

Roca-Buton kasete



Kodi	Përshkrimi	Cmimi
A890096001	Buton kasete PL2 DUAL I kromuar	-

Roca-Buton kasete



Kodi	Përshkrimi	Cmimi
A890095000	Buton kasete PL1 DUAL i bardhe	-

Roca-Buton kasete



Kodi	Përshkrimi	Cmimi
A8901160B0	Buton kasete 62B DUAL I bardhe	-

Roca-Buton kasete



Kodi	Përshkrimi	Cmimi
A8901160B1	Buton kasete 62B DUAL I kromuar	-

Roca-Buton kasete



Kodi	Përshkrimi	Cmimi
A890096002	Buton kasete PL 2 mat i kromuar	-

Roca-Buton kasete

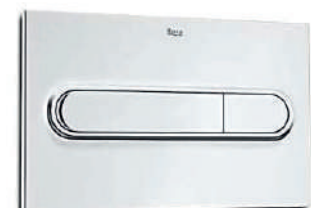

Kodi	Përshkrimi	Cmimi
A890095001	Buton kasete PL 1 dual I kromuar	-

ROCA - FRESIBEL

Roca-fresibel dushi



Kodi	Përshkrimi	Cmimi
A5B2116C00	Fresibel dushi 1.75m pvc	-

Roca-fresibel dushi



Kodi	Përshkrimi	Cmimi
A5B2416C00	Fresibel dushi 1.7 m pvc	-

Roca-fresibel dushi



Kodi	Përshkrimi	Cmimi
A5B2516C00	Fresibel dushi 1.5m pvc	-

Roca-Fresibel dushi



Kodi	Përshkrimi	Cmimi
A5B2616C00	Fresibel dushi 200 Neo Flex	-

Roca-Fresibel dushi



Kodi	Përshkrimi	Cmimi
A5B2716C00	Fresibel dushi 170	-

Roca-Fresibel dushi



Kodi	Përshkrimi	Cmimi
A5B2816C0	Fresibel dushi 150	-

Roca-Zorre dushi



Kodi	Përshkrimi	Cmimi
A5B2316C00	Zorre dushi PVC 200 Neo Flex	-

Roca-Zorre dushi



Kodi	Përshkrimi	Cmimi
A5B2016C00	Zorre dushi PVC 200	-

Roca-Zorre dushi



Kodi	Përshkrimi	Cmimi
A5B2216C00	Zorre dushi pvc 150 cm	-

Roca-Fresibel dushi



Kodi	Përshkrimi	Cmimi
A5B2116NB0	Fresibel dushi 1.75m,pvc mat i zi	-

Panele Diellore

Ngrohje & Ftohje

Hidraulike

Hidrosanitare

Aksesore të ndryshëm

Roca-Krahe koke dushi



Roca-Krahe koke dushi



Roca-Krahe koke dushi



Kodi	Përshkrimi	Cmimi
A5B0950C00	Krahe koke dushi 400x40mm	-

Kodi	Përshkrimi	Cmimi
A5B0750C00	Krahe koke dushi i rrumbullaket	-

Kodi	Përshkrimi	Cmimi
A5B0250C00	Krahe koke dushi 400mm e rrumbullaket	-

Roca-Krahe koke dushi



Roca- Krahe koke dushi



Roca- Krahe koke dushi



Kodi	Përshkrimi	Cmimi
A5B0250C00	Krahe koke dushi 400mm i rrumbullaket i zi	-

Kodi	Përshkrimi	Cmimi
A5B0350C00	Krahe koke dushi i drejte 500x75mm	-

Kodi	Përshkrimi	Cmimi
A5B0150C00	Krahe koke dushi 300x75mm	-

Roca- Krahe koke dushi



Roca- Krahe koke dushi



Roca-Krahe koke dushi



Kodi	Përshkrimi	Cmimi
A5B0450C00	Krahe koke dushi i drejte 100mm	-

Kodi	Përshkrimi	Cmimi
A5B0650C00	Krahe koke dushi i drejte 300mm	-

Kodi	Përshkrimi	Cmimi
A5B0550C00	Krahe koke dushi 200mm e rrumbullaket	-

Roca-Krahe koke dushi



Roca-Krahe koke dushi



Kodi	Përshkrimi	Cmimi
A5B1050C00	Krahe koke dushi tavanore	-

Kodi	Përshkrimi	Cmimi
A5B0550C00	Krahe koke dushi 200mm i rrumbullaket,i zi	-

Roca- Mbajtese koke dushi



Kodi	Përshkrimi	Cmimi
A5B5250CN0	Mbajtese koke dushi e rrrumbullaket ,e zeze	-

Roca- Mbajtese koke dushi



Kodi	Përshkrimi	Cmimi
A5B0850C00	Mbajtese koke dushi katrore e kromuar 1/2	-

Roca- Mbajtese koke dushi



Kodi	Përshkrimi	Cmimi
A5B5250C00	Mbajtese koke dushi e rrrumbullaket 70x70x95mm	-

Roca- Mbajtese koke dushi



Kodi	Përshkrimi	Cmimi
AG0068500R	Mbajtese koke dushi e rrrumbullaket	-

Roca- Mbajtese koke dushi



Kodi	Përshkrimi	Cmimi
A5B8150C00	Mbajtese koke dushi e rrrumbullaket 1/2	-

Roca-Grup pishuari



Kodi	Përshkrimi	Cmimi
A5A9277C00	Grup pishuari	-

Roca-Grup Pishuari



Kodi	Përshkrimi	Cmimi
A5A9077C00	Grup Pishuari kendore	-

Roca - Furce wc-je



Kodi	Përshkrimi	Cmimi
A81666001	Furce banjo	-

Roca- Mbajtese furce wc-je



Kodi	Përshkrimi	Cmimi
A816667001	Mbajtese furce wc-je ne xham 76x113x380mm	-

Roca- Mbajtese furce wc-je



Kodi	Përshkrimi	Cmimi
A816668001	Mbajtese furce wc-je 90x90x346mm	-

Roca- Mbajtese letre higjenike



Kodi	Përshkrimi	Cmimi
A816662001	Mbajtese letre higjenike me kapak 132x55x102mm	-

Roca- Mbajtese letre higjenike



Kodi	Përshkrimi	Cmimi
A816663001	Mbajtese letre higjenike 181x65x50mm	-

Roca- Mbajtese letre higjenike



Roca- Mbajtese sapuni ne xham



Roca- Mbajtese sapuni



Kodi	Përshkrimi	Cmimi
A816665001	Mbajtese letre higjenike 50x135x50mm	-

Kodi	Përshkrimi	Cmimi
A816683001	Mbajtese sapuni ne xham inkaso 110x130x50mm	-

Kodi	Përshkrimi	Cmimi
A5B5150C00	Mbajtese sapuni	-

Roca- Mbajtese sapuni



Roca- Mbajtese furce dhembesh



Roca- Mbajtese shampo



Kodi	Përshkrimi	Cmimi
A5B5150TP0	Mbajtese sapuni transparent	-

Kodi	Përshkrimi	Cmimi
A816681001	Mbajtese furce dhembesh ne xham 76x113x119mm	-

Kodi	Përshkrimi	Cmimi
A816678001	Mbajtese shampo 76x126x163mm	-

Roca- Mbajtese shampo



Roca- Mbajtese shampo



Roca- Mbajtese kendore

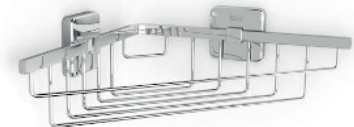

Kodi	Përshkrimi	Cmimi
A816679001	Mbajtese shampo 62x80x184mm	-

Kodi	Përshkrimi	Cmimi
A816677001	Mbajtese shampo inkaso 64x104x184mm	-

Kodi	Përshkrimi	Cmimi
A816685001	Mbajtese kendore 210x210x80mm	-

Roca- Mbajtese kendore

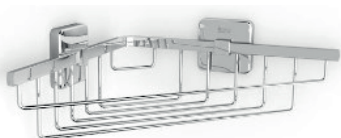

Roca- Mbajtese grille kendore

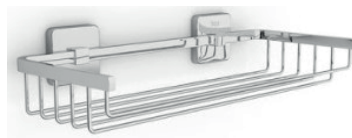

Roca- Mbajtese kendore

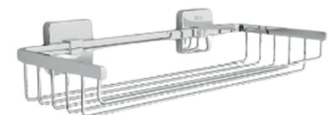

Kodi	Përshkrimi	Cmimi
A816686001	Mbajtese kendore grille 260x260x80mm	-

Kodi	Përshkrimi	Cmimi
A816687001	Mbajtese grille 200x115x50mm	-

Kodi	Përshkrimi	Cmimi
A816688001	Mbajtese kendore 300x135x65 mm	-

Roca- Mbajtese peshqiri

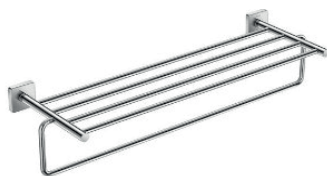

Kodi	Përshkrimi	Cmimi
A816660001	Mbajtese peshqiri 600mm e rrumbullaket	-

Roca- Mbajtese peshqiri



Kodi	Përshkrimi	Cmimi
A816659001	Mbajtese peshqiri 200x50x220mm e rrumbullaket	-

Roca- Mbajtese peshqiri



Kodi	Përshkrimi	Cmimi
A816653001	Mbajtese peshqiri 300x64x50mm	-

Roca- Mbajtese peshqiri



Kodi	Përshkrimi	Cmimi
A816655001	Mbajtese peshqiri 500mm	-

Roca- Mbajtese peshqiri



Kodi	Përshkrimi	Cmimi
A816655001	Mbajtese peshqiri 400mm	-

Roca- Mbajtese peshqiri



Kodi	Përshkrimi	Cmimi
A816656001	Mbajtese peshqiri 600mm 50X64X600	-

Roca- Mbajtese peshqiri



Kodi	Përshkrimi	Cmimi
A816658001	Mbajtese peshqiri dopjo 30x317x50mm	-

Roca- Mbajtese peshqiri lavamani



Kodi	Përshkrimi	Cmimi
A816291001	Mbajtese peshqiri lavamani 282x64x25mm	-

Roca- Raft xhami



Kodi	Përshkrimi	Cmimi
A816661001	Raft xhami 600x108x50mm	-

Roca- Grep me 1 pjese



Kodi	Përshkrimi	Cmimi
A816650001	Grep me 1 pjese 50x55x50mm	-

Roca- Grep me 2 pjese



Kodi	Përshkrimi	Cmimi
A816651001	Grep me 2 pjese 130x47x40mm	-

Roca- Grep me 4 pjese



Kodi	Përshkrimi	Cmimi
A816652001	Grep me 4 pjese 310x47x40mm	-

Roca- Galixhan



Kodi	Përshkrimi	Cmimi
AV0017900R	Galixhan per kaset inkaso Duplo Compact	-

Roca- Kit suporti



Kodi	Përshkrimi	Cmimi
AV0018200R	Kit suporti per mekanizmin shtypes per Duplo Compact 8 cm	-

Roca- Aksesori mekanizmi shkarkues



Kodi	Përshkrimi	Cmimi
AV0018000R	Aksesori mekanizmi shkarkues per Duplo Compact 8cm	-

Roca-Gomina e mekanizmit



Kodi	Përshkrimi	Cmimi
AV0018100R	Gomina e mekanizmit per Duplo Compact 8 cm	-

Roca- Set tubi shkarkimesh



Kodi	Përshkrimi	Cmimi
AV0018600R	Set tubi shkarkimesh +reduktor 100x90 +50 per kaset inkaso dublo kompakt 8 cm	-

Roca-Set valvule hyrese



Kodi	Përshkrimi	Cmimi
AV0024100R	Set valvule hyrese per kaset inkaso Active	-

Roca-Set montimi piastrash



Kodi	Përshkrimi	Cmimi
AV0000900R	Set montimi piastrash per butonin e kasetes inkaso	-

Roca-Set aksesori galixhanti



Kodi	Përshkrimi	Cmimi
AV0022600R	Set aksesori galixhanti per kaset inkaso Active	-

Roca-Aksesore per kasete inkaso



Kodi	Përshkrimi	Cmimi
A890063000	Aksesore per kaset inkaso Silent	-

Roca- Zgjatues



Kodi	Përshkrimi	Cmimi
A525564303	Zgjatues per kuti universale	-

Roca-Unaze



Kodi	Përshkrimi	Cmimi
A525564600	Unaze per kuti universale	-

Roca-Unaze



Kodi	Përshkrimi	Cmimi
A525564700	Unaze me skelet katror	-

ROCA - AKSESORE

Roca- Sifon lavamani



Kodi	Përshkrimi	Cmimi
A506403810	Sifon lavamani inoksi fi 1.1/4 Minimal 380x105x80 mm	-

Roca- Sifon lavamani



Kodi	Përshkrimi	Cmimi
A506403110	Sifon lavamani inoksi fi 1.1/4 355X115X75 mm	-

Roca- Pilete



Kodi	Përshkrimi	Cmimi
A505401100	Pilete klik-klak universale fi 65	-

Roca-Pilet



Kodi	Përshkrimi	Cmimi
A505400900	Pilet klik-klak 1.1/4 fi 40	-

Roca- Brryl shkarkimi



Kodi	Përshkrimi	Cmimi
AV0026400R	fi 50	-
AV0023000R	fi 90 87grad f+m	-

Roca- Brryl shkarkimi



Kodi	Përshkrimi	Cmimi
AV0026300R	Brryl shkarkimi per kaset inkaso Active fi 100 87grad f+m	-

Roca-Grup lavamani



Kodi	Përshkrimi	Cmimi
A5252206CN	Grup lavamani me deviator	-

Roca-Kuti universale

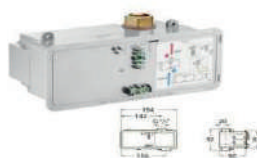

Kodi	Përshkrimi	Cmimi
A525891203	Kuti universale per grup inkaso	-

Roca-Kuti universale



Kodi	Përshkrimi	Cmimi
A525891003	Kuti universale per grup inkaso gri	-

Roca-Kuti universale



Kodi	Përshkrimi	Cmimi
A525869403	Kuti universale per grup inkaso blu	-

Roca- Mini filter banjoje



Kodi	Përshkrimi	Cmimi
A525164400	Mini filter banjoje inoks +rozet 1/2-3/8	-

Roca-Brryl i kromuar



Kodi	Përshkrimi	Cmimi
A5B1150C00	Brryl i kromuar 1/2,katrore	-

Roca-Vida per kapak



Roca-Vida per kapak



Roca-Set montimi i kasetes inkaso



Kodi	Përshkrimi	Cmimi
WM951MDZ A000004	Vida per kapak Gap Soft Closing	-

Kodi	Përshkrimi	Cmimi
AI0011200R	Vida per kapak Debba Soft Closing	-

Kodi	Përshkrimi	Cmimi
AV0001000R	Set montimi i kasetes inkaso	-

DEMME

RUBINETTERIA



Demm
the essence
of water

2022

bathroom collections

LUI. Koleksion.

Forma të thjeshta por ndjellëse,
simbole ikonike



Simbole ikonike, forma të thjeshta por ndjellëse, një shenjë stenografi që mishëron jo vetëm formën, por edhe kuptimin. Koleksioni i propozuar LUI pasuron hapësirat e jetesës, duke krijuar emocione në një produkt për përdorim të përditshëm.

Panele Diellore

Ngrohje & Ftohje

Hidraulike

Hidrosanitare

Aksesore të ndryshëm

Demm-Grup lavamani



Demm-Grup lavamani



Demm-Grup bide



Kodi	Përshkrimi	Cmimi
9110	Grup lavamani	-

Kodi	Përshkrimi	Cmimi
9114	Grup Lavamani	-

Kodi	Përshkrimi	Cmimi
9120	Grup bide	-

Demm-Grup vaske



Demm-Grup dushi



Demm-Grup dushi



Kodi	Përshkrimi	Cmimi
9100	Grup vaske	-

Kodi	Përshkrimi	Cmimi
9130	Grup dushi	-

Kodi	Përshkrimi	Cmimi
9140	Grup dushi pa deviator	-

Demm-Grup dushi



Kodi	Përshkrimi	Cmimi
9150	Grup dushi me deviato	-



LEI. Koleksion.

Ekuilibri midis stilit dhe dizajnit,
harmonia e formës

Harmonia e formës bazohet në rregull, dizajni i koleksionit LEI e përforcon këtë koncept, ekuilibri midis stilit dhe dizajnit i jep koleksionit një veshje aktuale duke e bërë atë protagonist të panoramës aktuale të brendshme.

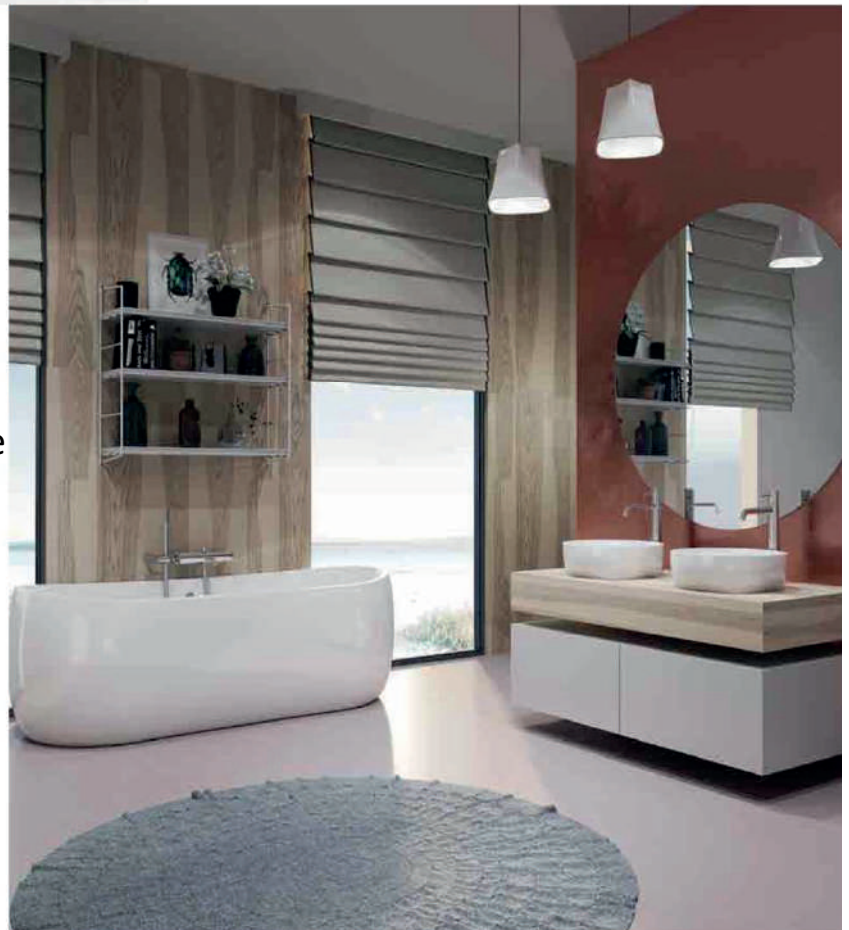

Panele Diellore

Ngrohje & Ftohje

Hidraulike

Hidrosanitare

Aksesore të ndryshëm

Demm-Grup lavamani



Demm-Grup lavamani



Demm-Grup bide



Kodi	Përshkrimi	Cmimi
9210	Grup lavamani	-

Kodi	Përshkrimi	Cmimi
9214	Grup Lavamani	-

Kodi	Përshkrimi	Cmimi
9220	Grup Bideje	-

Demm-Grup vaske



Demm-Grup dushi



Demm-Grup dushi



Kodi	Përshkrimi	Cmimi
9200	Grup Vaske	-

Kodi	Përshkrimi	Cmimi
9230	Grup Dushi	-

Kodi	Përshkrimi	Cmimi
9240	Grup Dushi pa deviator	-

Demm-Grup dushi



Kodi	Përshkrimi	Cmimi
9250	Grup Dushi me deviator	-

Panele Diellore

Ngrohje & Ftohje

Hidraulike

Hidrosanitare

Aksesore të ndryshëm

ACIARIUM. koleksion



Fisnike dhe e çmuar, e qëndrueshme në kohë

Panele Dielllore

Ngrohje & Ftohje

Hidraulike

Hidrosanitare

Aksesore të ndryshëm

Demm-Grup lavamani



Kodi	Përshkrimi	Cmimi
9010	Grup Lavamani	-

Demm-Grup lavamani



Kodi	Përshkrimi	Cmimi
9014	Grup Lavamani	-

Demm-Grup lavamani



Kodi	Përshkrimi	Cmimi
9018	Grup Lavamani	-

Demm-Grup bide



Kodi	Përshkrimi	Cmimi
9020	Grup Bideje	-

Demm-Grup vaske



Kodi	Përshkrimi	Cmimi
9000	Grup Vaske	-

Demm-Grup vask



Kodi	Përshkrimi	Cmimi
9005	Grup Vaske	-

Demm-Grup dushi



Kodi	Përshkrimi	Cmimi
9040	Grup Dushi pa deviator	-

Demm-Grup dushi



Kodi	Përshkrimi	Cmimi
9050	Grup Dushi me deviator	-

Demm-Grup vaske



Kodi	Përshkrimi	Cmimi
9007	Grup Vaske	-

Demm-Grup vaske



Kodi	Përshkrimi	Cmimi
9035	Grup Vaske	-

Demm-Grup lavamani



Kodi	Përshkrimi	Cmimi
9015	Grup Lavamani	-

Demm-Grup vaske



Kodi	Përshkrimi	Cmimi
9002	Grup Vaske	-

Panele Diellore

Ngrohje & Ftohje

Hidraulike

Hidrosanitare

Aksesore të ndryshëm

SERIA ACIARIUM

Demm-Koke dushi

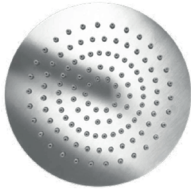

Kodi	Përshkrimi	Cmimi
9060	Kokë dushi	-

Demm-Koke dushi



Kodi	Përshkrimi	Cmimi
9065	koke e dushit	-

Demm-Grup dushi



Kodi	Përshkrimi	Cmimi
9070	Kit dushi	-

Demm-Grup dushi



Kodi	Përshkrimi	Cmimi
9073	Komplet dushi	-

Demm-Krahe dushi



Kodi	Përshkrimi	Cmimi
9066	Krahu dushi	-

Demm-Grup dushi



Kodi	Përshkrimi	Cmimi
9072	Kit dushit	-

Demm-koke marrje uji



Kodi	Përshkrimi	Cmimi
9075	Koke marrje uji	-

Demm-Mbeshtetje koke dushi



Kodi	Përshkrimi	Cmimi
9077	Mbështetje për koke dushi	-

Demm-Koke dushi cilindrik



Kodi	Përshkrimi	Cmimi
9079	Koke dushi cilindrik	-

Demm-Koke kulluese uji



Kodi	Përshkrimi	Cmimi
9081	Koke kulluese uji	-

Demm- Sifon për lavaman



Kodi	Përshkrimi	Cmimi
9083	Sifon për lavaman	-

Demm-Mbeshtetje koke dushi



Kodi	Përshkrimi	Cmimi
9078	Mbeshtetje koke dushi	-

Panele Diellore

Ngrohje & Ftohje

Hidraulike

Hidrosanitare

Aksesore të ndryshëm

Demm-Fleksibël



Kodi	Përshkrimi	Cmimi
9080	Fleksibël	-

Demm- Rubinet



Kodi	Përshkrimi	Cmimi
9082	Rubinet per lavaman	-

Demm-Pllake tualeti per shpëlarje



Kodi	Përshkrimi	Cmimi
9084	Pllakë WC per shperlarje	-

Demm-Grup lavamani



Kodi	Përshkrimi	Cmimi
9090	Grup lavamani	-

Demm-Grup lavamani



Kodi	Përshkrimi	Cmimi
9091	Grup lavamani	-

Demm-Grup lavamani



Kodi	Përshkrimi	Cmimi
9092	Grup lavamani	-

Demm-Grup dushi



Kodi	Përshkrimi	Cmimi
9095	Grup dushi	-

Panele Diellore

Ngrohje & Ftohje

Hidraulike

Hidrosanitare

Aksesore të ndryshëm



MY TIME. koleksion.

Në thelb jam i lirë, e përkufizoj veten si të përjetshëm

MY TIME ofron një estetikë të sofistikuar por jo mbizotëruese brenda banjës, detajet janë të dukshme por bëhen njësh me kontekstin. Ambicia për të qenë një produkt i përjetshëm tregon karakterin e tij të lirë. Thelbësore, konkrete dhe pragmatike.



Panele Dielllore

Ngrohje & Ftohje

Hidraulike

Hidrosanitare

Aksesore të ndryshëm

Demm-Grup lavamani

C



Kodi	Përshkrimi	Cmimi
7110	Grup lavamani	-

Demm-Grup lavamani

ES



Kodi	Përshkrimi	Cmimi
7110	Grup lavamani	-

Demm-Grup lavamani

KS



Kodi	Përshkrimi	Cmimi
7110	Grup lavamani	-

Demm-Grup lavamani

D



Kodi	Përshkrimi	Cmimi
7110	Grup lavamani	-

Demm-Grup lavamani

RG



Kodi	Përshkrimi	Cmimi
7110	Grup lavamani	-

Demm-Grup lavamani

GS



Kodi	Përshkrimi	Cmimi
7110N	Grup lavamani	-

Demm-Grup lavamani

ZG



Kodi	Përshkrimi	Cmimi
7110	Grup lavamani	-

Demm-Grup lavamani

NU



Kodi	Përshkrimi	Cmimi
7110	Grup lavamani	-

Demm-Grup lavamani

CS



Kodi	Përshkrimi	Cmimi
7110	Grup lavamani	-

Demm-Grup lavamani

DS



Kodi	Përshkrimi	Cmimi
7110N	Grup lavamani	-

Demm-Grup lavamani

RS



Kodi	Përshkrimi	Cmimi
7110N	Grup lavamani	-

Panele Diellore

Ngrohje & Ftohje

Hidraulike

Hidrosanitare

Aksesore të ndryshëm

Demm-Grup lavamani



Kodi	Përshkrimi	Cmimi
7114	Grup lavamani	-

Demm-Grup lavamani



Kodi	Përshkrimi	Cmimi
7118	Grup lavamani	-

Demm-Grup bide



Kodi	Përshkrimi	Cmimi
7120	Grup bide	-

Demm-Grup vaske



Kodi	Përshkrimi	Cmimi
7100	Grup vaske	-

Demm-Grup dushi



Kodi	Përshkrimi	Cmimi
7130	Grup dushi	-

Demm-Grup dushi



Kodi	Përshkrimi	Cmimi
7140	Grup dushi pa deviator	-

Demm-Grup dushi



Kodi	Përshkrimi	Cmimi
7150	Grup dushi me deviator	-



TIMELESS. koleksion.

Në shërbimin e relaksimit tuaj

Personaliteti i fortë, shpirti i gjelbër, TIMELESS pushton panoramën e re shtëpiake, leva ergonomike përmirëson kapjen edhe me duar me sapun. TIMELESS, pikërisht në shërbimin tuaj, për të shijuar momente të pastër relaksi, duke respektuar mjedisin.

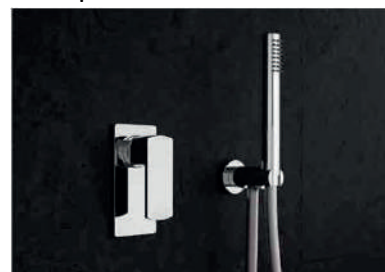



SERIA TIMELESS

Demm-Grup lavamani



Kodi	Përshkrimi	Cmimi
7410	Grup lavamani	-

Demm-Grup lavamani



Kodi	Përshkrimi	Cmimi
7414	Grup lavamani	-

Demm-Grup lavamani



Kodi	Përshkrimi	Cmimi
7418	Grup lavamani	-

Demm-Grup bide



Kodi	Përshkrimi	Cmimi
7420	Grup bide	-

Demm-Grup vaske



Kodi	Përshkrimi	Cmimi
7400	Grup vaske	-

Demm-Grup dushi



Kodi	Përshkrimi	Cmimi
7430	Grup dushi	-

Demm-Grup dushi



Kodi	Përshkrimi	Cmimi
7440	Grup dushi pa deviator	-

Demm-Grup dushi



Kodi	Përshkrimi	Cmimi
7450	Grup dushi me deviator	-

Panele Dielllore

Ngrohje & Ftohje

Hidraulike

Hidrosanitare

Aksesore të ndryshëm

Rigoroziteti i përdredhur, kombinimi i duhur i elegancës dhe qëndrueshmërisë

Rigoroziteti i formës, i lehtësuar nga linjat e përkulura, kombinimi i duhur i elegancës dhe qëndrueshmërisë, këto janë pikat dalluese që karakterizojnë koleksionin SHINE. Shkëlqimi i skajeve, reflektimi i kthesave të buta i japin banjës një ndjenjë të thellë elegancë dhe qetësie.

Panele Dielllore

Ngrohje & Ftohje

Hidraulike

Hidrosanitare

Aksesore të ndryshëm



SERIA SHINE

Demm-Grup lavamani



Kodi	Përshkrimi	Cmimi
7210	Grup lavamani	-

Demm-Grup lavamani



Kodi	Përshkrimi	Cmimi
7214	Grup lavamani	-

Demm-Grup bide



Kodi	Përshkrimi	Cmimi
7220	Grup bide	-

Demm-Grup vaske



Kodi	Përshkrimi	Cmimi
7200	Grup vaske	-

Demm-Grup dushi



Kodi	Përshkrimi	Cmimi
7230	Grup dushi	-

Demm-Grup dushi



Kodi	Përshkrimi	Cmimi
7240	Grup dushi pa deviator	-

Demm-Grup dushi



Kodi	Përshkrimi	Cmimi
7250	Grup dushi me deviator	-

Panele Dielllore

Ngrohje & Ftohje

Hidraulike

Hidrosanitare

Aksesore të ndryshëm

Në harmoni të plotë me veten dhe ambientin

Karakteri i tij modern, silueta ergonomike dhe e pastër përfaqësojnë traditën e pastër DEMM, pamja e saj e bardhë dhe e ndritshme sugjeron një mënyrë jetese të ekuilibruar në harmoni totale me veten dhe mjedisin, DRAKE optimizon burimet duke ndihmuar konsumatorin të kursejë çdo ditë ujë dhe energji.



Panelle Diellore

Ngrohje & Ftohje

Hidraulike

Hidrosanitare

Aksesore të ndryshëm



SERIA DRAKE

Demm-Grup lavamani



Kodi	Përshkrimi	Cmimi
7310	Grup lavamani	-

Demm-Grup lavamani



Kodi	Përshkrimi	Cmimi
7314	Grup lavamani	-

Demm-Grup bide



Kodi	Përshkrimi	Cmimi
7320	Grup bide	-

Demm-Grup vaske



Kodi	Përshkrimi	Cmimi
7300	Grup vaske	-

Demm-Grup dushi



Kodi	Përshkrimi	Cmimi
7330	Grup dushi	-

Demm-Grup dushi



Kodi	Përshkrimi	Cmimi
7340	Grup dushi pa deviator	-

Demm-Grup dushi



Kodi	Përshkrimi	Cmimi
7350	Grup dushi me deviator	-

Panele Dielllore

Ngrohje & Ftohje

Hidraulike

Hidrosanitare

Aksesore të ndryshëm



Shprehni stilin tuaj,
mos ndiqni moden

Ambienti i banjes duhet jo vetem per te ndjek moden por edhe te shpreh stilin e tij, ata qe vlersojne personalizimin diskret do te dashurohen me linjen tone te cezmes SLEEK, fale perfundimeve te ndryshme eshte e mundur te krijohet efekte kromatike me ndikim te larte.



SERIA SLEEK

Demm-Grup lavamani



Kodi	Përshkrimi	Cmimi
9910	Grup lavamani	-

Demm-Grup lavamani



Kodi	Përshkrimi	Cmimi
9910NU	Grup lavamani	-

Demm-Grup lavamani



Kodi	Përshkrimi	Cmimi
9910HU	Grup lavamani	-

Demm-Grup lavamani



Kodi	Përshkrimi	Cmimi
9910ZB	Grup lavamani	-

Demm-Grup lavamani



Kodi	Përshkrimi	Cmimi
9910T	Grup lavamani	-

Demm-Grup lavamani



Kodi	Përshkrimi	Cmimi
9910RG	Grup lavamani	-

Demm-Grup lavamani



Kodi	Përshkrimi	Cmimi
9910RM	Grup lavamani	-

Panele Diellore

Ngrohje & Ftohje

Hidraulike

Hidrosanitare

Aksesore të ndryshëm

Demm-Grup lavamani



Kodi	Përshkrimi	Cmimi
9914	Grup lavamani	-

Demm-Grup lavamani



Kodi	Përshkrimi	Cmimi
9918	Grup lavamani	-

Demm-Grup bide



Kodi	Përshkrimi	Cmimi
9920	Grup bide	-

Demm-Grup vaske



Kodi	Përshkrimi	Cmimi
9900	Grup vaske	-

Demm-Grup dushi



Kodi	Përshkrimi	Cmimi
9930	Grup dushi	-

Demm-Grup dushi



Kodi	Përshkrimi	Cmimi
9940	Mishelator dushi pa deviator	-

Demm-Grup dushi



Kodi	Përshkrimi	Cmimi
9950	Grup dushi me deviator	-

Demm-Grup dushi



Kodi	Përshkrimi	Cmimi
16099	Grup dushi	-

Panele Diellore

Ngrohje & Ftohje

Hidraulike

Hidrosanitare

Aksesore të ndryshëm

SILK. koleksion.

Funksionaliteti i studiuar hollësisht

Ambienti modern i banjës kërkon zgjidhje aktuale, në këtë këndvështrim një dizajn i rafinuar në hap me kohën luan një rol vendimtar. Koleksioni SILK, funksionalitet i studiuar në detaje me një stil që nuk ndjek vetëm modën.



Panele Djellore

Ngrohje & Ftohje

Hidraulike

Hidrosanitare

Aksesore të ndryshëm

Demm-Grup lavamani



Kodi	Përshkrimi	Cmimi
6910	Grup lavamani	-

Demm-Grup lavamani



Kodi	Përshkrimi	Cmimi
6914	Grup lavamani	-

Demm-Grup lavamani



Kodi	Përshkrimi	Cmimi
6918	Grup lavamani	-

Demm-Grup bide



Kodi	Përshkrimi	Cmimi
6920	Grup bide	-

Demm-Grup vaske



Kodi	Përshkrimi	Cmimi
6900	Grup vaske	-

Demm-Grup dushi



Kodi	Përshkrimi	Cmimi
6930	Grup dushi	-

Demm-Grup dushi



Kodi	Përshkrimi	Cmimi
6940	Grup dushi pa deviator	-

Demm-Grup dushi



Kodi	Përshkrimi	Cmimi
6950	Grup dushi me deviator	-

Panele Diellore

Ngrohje & Ftohje

Hidraulike

Hidrosanitare

Aksesore të ndryshëm

Bukuri e pastër ne forme te lakuar



Silueta është e veshur me një sipërfaqe të përkryer të lëmuar e cila rrit bukurinë e pastër të formës së lakuar, dizajni i saj thelbësor lë hapësirë dhe përshtatet mirë me çdo stil të arredimit të banjës.

Panele Dielllore

Ngrohje & Ftohje

Hidraulike

Hidrosanitare

Aksesore të ndryshëm

Demm-Grup lavamani

C



Kodi	Përshkrimi	Cmimi
6110	Grup lavamani	-

Demm-Grup lavamani

ES



Kodi	Përshkrimi	Cmimi
6110	Grup lavamani	-

Demm-Grup lavamani

KS



Kodi	Përshkrimi	Cmimi
6110	Grup lavamani	-

Demm-Grup lavamani

D



Kodi	Përshkrimi	Cmimi
6110	Grup lavamani	-

Demm-Grup lavamani

RG



Kodi	Përshkrimi	Cmimi
6110	Grup lavamani	-

Demm-Grup lavamani

NU



Kodi	Përshkrimi	Cmimi
6110N	Grup lavamani	-

Demm-Grup lavamani

ZG



Kodi	Përshkrimi	Cmimi
6110	Grup lavamani	-

Demm-Grup lavamani

GS



Kodi	Përshkrimi	Cmimi
6110	Grup lavamani	-

Demm-Grup lavamani

CS



Kodi	Përshkrimi	Cmimi
6110	Grup lavamani	-

Demm-Grup lavamani

DS



Kodi	Përshkrimi	Cmimi
6110N	Grup lavamani	-

Demm-Grup lavamani

RS



Kodi	Përshkrimi	Cmimi
6110N	Grup lavamani	-

Panele Diellore

Ngrohje & Ftohje

Hidraulike

Hidrosanitare

Aksesore të ndryshëm

Demm-Grup lavamani



Kodi	Përshkrimi	Cmimi
6114	Grup lavamani	-

Demm-Grup lavamani



Kodi	Përshkrimi	Cmimi
6118	Grup lavamani	-

Demm-Grup bide



Kodi	Përshkrimi	Cmimi
6120	Grup bide	-

Demm-Grup vaske



Kodi	Përshkrimi	Cmimi
6100	Grup vaske	-

Demm-Grup dushi



Kodi	Përshkrimi	Cmimi
6130	Grup dushi	-

Demm-Grup dushi



Kodi	Përshkrimi	Cmimi
6140	Mishelator dushi pa deviator	-

Demm-Grup dushi



Kodi	Përshkrimi	Cmimi
6150	Mishelator dushi me deviator	-

Linjat thelbësore dhe planifikimi i menjëhershëm për një estetikë puriste për t'u përjetuar. Koleksioni i ri SPIKE përmban në thjeshtësinë e tij formale të gjithë njohuritë tona teknike, funksionalitetin dhe dizajnin në shërbimin tuaj!

Aty ku ka shumë dritë, hija është më e zezë

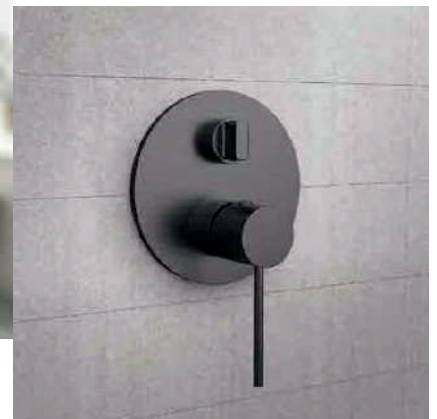

SERIA SPIKE

Demm-Grup lavamani



Kodi	Përshkrimi	Cmimi
6810	Grup lavamani	-

Demm-Grup lavamani



Kodi	Përshkrimi	Cmimi
6814	Grup lavamani	-

Demm-Grup lavamani



Kodi	Përshkrimi	Cmimi
6818	Grup lavamani	-

Panele Diellore

Ngrohje & Ftohje

Hidraulike

Hidrosanitare

Aksesore të ndryshëm

Demm-Grup lavamani



Kodi	Përshkrimi	Cmimi
6819	Grup lavamani	-

Demm-Grup vaske



Kodi	Përshkrimi	Cmimi
6805	Grup vaske	-

Demm-Grup bide



Kodi	Përshkrimi	Cmimi
6820	Grup bide	-

Demm-Grup vaske



Kodi	Përshkrimi	Cmimi
6800	Grup vaske	-

Demm-Grup dushi



Kodi	Përshkrimi	Cmimi
6830	Grup dushi	-

Demm-Grup dushi



Kodi	Përshkrimi	Cmimi
6840	Grup dushi pa deviator	-

Demm-Grup dushi



Kodi	Përshkrimi	Cmimi
6850	Grup dushi me deviator	-

Demm-Grup dushi



Kodi	Përshkrimi	Cmimi
6855	Grup dushi me deviator	-

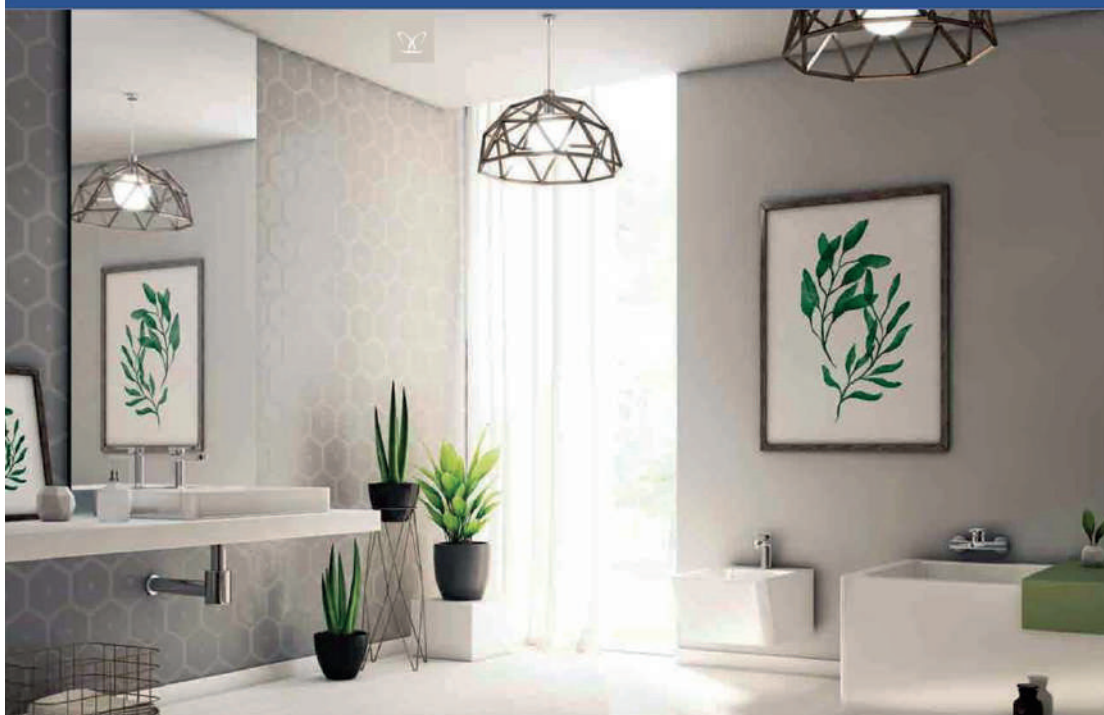

ELITE. koleksion.

Përjetoni
emocionet
tuaja me një
gjest të
thjeshtë

Përjetoni emocionet tuaja me një gjest të thjeshtë, koleksioni ynë ELITE, falë dizajnit të tij të thjeshtë të karakterizuar nga linja të pastra, pasqyron nevojat e një publiku gjithnjë e më të vëmendshëm.

Ngjyrat, si tiparet, ndjekin
ndryshimet në emocion



SERIA ELIT

Demm-Grup lavamani



Kodi	Përshkrimi	Cmimi
7010	Grup lavamani	-

Demm-Grup lavamani



Kodi	Përshkrimi	Cmimi
7018	Grup lavamani	-

Demm-Grup bide



Kodi	Përshkrimi	Cmimi
7020	Grup bide	-

Demm-Grup vaske



Kodi	Përshkrimi	Cmimi
7000	Grup vaske	-

Demm-Grup dushi



Kodi	Përshkrimi	Cmimi
7030	Grup dushi	-

Demm-Grup dushi



Kodi	Përshkrimi	Cmimi
7040	Grup dushi pa deviator	-

Demm-Grup dushi



Kodi	Përshkrimi	Cmimi
7050	Grup dushi me deviator	-

ART.7095



N

ART.7095

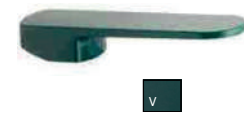

V

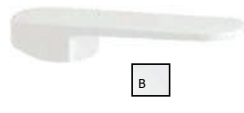

B

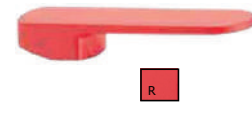

R



C

Panele Diellore

Ngrohje & Ftohje

Hidraulike

Hidrosanitare

Aksesore të ndryshëm



Pasion dhe harmoni ne ekuilibrin e duhur

Estetika dhe lëvizja karakterizojnë MOVE... E lehtë dhe e pastër në formë, kombinon maturinë dhe thjeshtësinë, duke iu përshtatur më së miri shijeve të kërkesave më kërkuese. Pasioni dhe harmonia ruajnë ekuilibrin e duhur për një banjë që është një vepër arti.



SERIA MOVE

Demm-Grup lavamani



Demm-Grup lavamani



Demm-Grup lavamani



Kodi	Përshkrimi	Cmimi
9710	Grup dushi	-

Kodi	Përshkrimi	Cmimi
9714	Grup lavamani	-

Kodi	Përshkrimi	Cmimi
9718	Grup lavamani	-

Demm-Grup bide



Demm-Grup vaske



Demm-Grup dushi



Kodi	Përshkrimi	Cmimi
9720	Grup bide	-

Kodi	Përshkrimi	Cmimi
9700	Grup vaske	-

Kodi	Përshkrimi	Cmimi
9730	Grup dushi	-

Demm-Grup dushi



Demm-Grup dushi



Kodi	Përshkrimi	Cmimi
9740	Grup dushi pa deviator	-

Kodi	Përshkrimi	Cmimi
9750	Grup dushi me deviator	-

Panele Diellore

Ngrohje & Ftohje

Hidraulike

Hidrosanitare

Aksesore të ndryshëm

KUOVADIS. koleksion.

Skajet dhe
shkëlqimi, thelbi i
minimalizmit

Skajet e mprehta dhe shkëlqimi i sipërfaqeve të kujtojnë thelbin e minimalizmit, prerja katrore kënaq qiellzën e "dhëmbit më të ëmbël". Duke ndërthurur bukurinë në formë dhe praktike, ai e shndërron një ide në një element racional plot butësi dhe originalitet, duke dhënë një dritë harmonike.

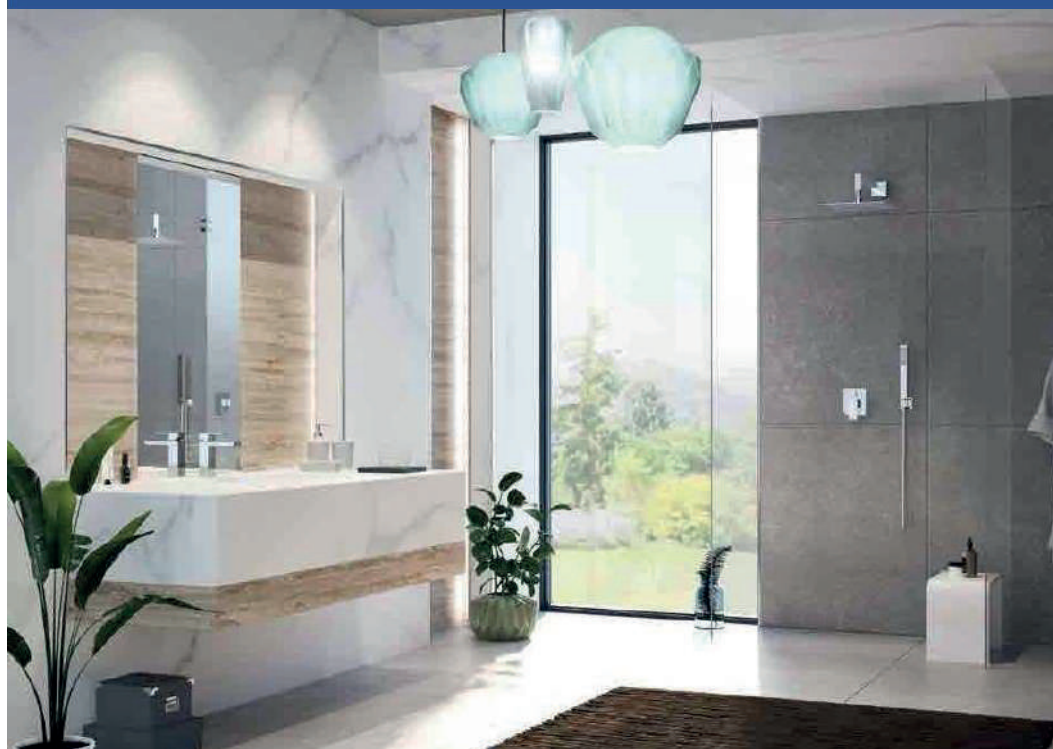

SERIA KUOVADIS

Demm-Grup lavamani



Demm-Grup lavamani



Demm-Grup lavamani



Kodi	Përshkrimi	Cmimi
9510	Grup lavamani	-

Kodi	Përshkrimi	Cmimi
9514	Grup lavamani	-

Kodi	Përshkrimi	Cmimi
9518	Grup lavamani	-

Demm-Grup bide



Demm-Grup vaske



Demm-Stende dyshemeje



Kodi	Përshkrimi	Cmimi
9520	Grup bide	-

Kodi	Përshkrimi	Cmimi
9500	Grup vaske	-

Kodi	Përshkrimi	Cmimi
9505	Stende dyshemeje	-

Demm-Grup dushi



Demm-Grup dushi



Demm-Grup dushi



Kodi	Përshkrimi	Cmimi
9533	Grup dushi	-

Kodi	Përshkrimi	Cmimi
9530	Grup dushi	-

Kodi	Përshkrimi	Cmimi
9540	Grup dushi pa deviator	-

Demm-Grup dushi



Kodi	Përshkrimi	Cmimi
9550	Grup dushi me deviator	-

Panele Dielllore

Ngrohje & Ftohje

Hidraulike

Hidrosanitare

Aksesore të ndryshëm

Thjeshtësia nuk është sinonim i mungesës

GRANGE. koleksion.



Një stil harmonik, "një dizajn" që mbetet i pandryshuar me kalimin e kohës... I përshtatshëm për të gjitha banjot që kërkojnë klasicizëm dhe dinamizëm, i ofruar në përfundime të ndryshme, jep një prekje të veçantë duke ruajtur thjeshtësinë si tipar kryesor.



Demm-Grup lavamani



Demm-Grup lavamani



Demm-Grup bide



Kodi	Përshkrimi	Cmimi
4310	Grup lavamani	-

Kodi	Përshkrimi	Cmimi
4318	Grup lavamani	-

Kodi	Përshkrimi	Cmimi
4320	Grup bide	-

Demm-Grup vaske



Demm-Grup dushi



Demm-Grup dushi



Kodi	Përshkrimi	Cmimi
4300	Grup vaske	-

Kodi	Përshkrimi	Cmimi
4330	Grup dushi	-

Kodi	Përshkrimi	Cmimi
4340	Grup dushi pa deviator	-

Demm-Grup dushi



Kodi	Përshkrimi	Cmimi
4350	Grup dushi me deviator	-



MODA. koleksion.

Lineare dhe harmonike, një kompromis i shkëlqyer



Një klasik gjithmonë i pranishëm. Një kompromis i mirë midis një stili linear dhe harmonik që plotëson një përzgjedhje të gjerë të orendive të banjës.... praktikiteti dhe bukuria e bëjnë "Moda" unike.



Demm-Grup lavamani



Kodi	Përshkrimi	Cmimi
4810	Grup lavamani	-

Demm-Grup lavamani



Kodi	Përshkrimi	Cmimi
4814	Grup lavamani	-

Demm-Grup lavamani



Kodi	Përshkrimi	Cmimi
4818	Grup lavamani	-

Demm-Grup bide



Kodi	Përshkrimi	Cmimi
4820	Grup bide	-

Demm-Grup vaske



Kodi	Përshkrimi	Cmimi
4800	Grup vaske	-

Demm-Grup dushi



Kodi	Përshkrimi	Cmimi
4830	Grup dushi	-

Demm-Grup dushi



Kodi	Përshkrimi	Cmimi
4840	Grup[dushi pa deviator	-

Demm-Grup dushi



Kodi	Përshkrimi	Cmimi
4850	Grup dushi me deviator	-



Linja të reja dhe të adaptueshme, gjithmonë aktuale dhe funksionale në çdo ambient banjo, kompromisi i shkëlqyer cilësi-çmim. Këto janë tiparet kryesore të Ivory, një prekje originaliteti për ata që nuk duan të guxojnë shumë.

SERIA IVORY

Demm-Grup lavamani



Kodi	Përshkrimi	Cmimi
4910	Grup lavamani	-

Demm-Grup bide



Kodi	Përshkrimi	Cmimi
4920	Grup bide	-

Demm-Grup vaske



Kodi	Përshkrimi	Cmimi
4900	Grup vaske	-

Demm-Grup dushi



Kodi	Përshkrimi	Cmimi
4930	Grup dushi	-

Demm-Grup dushi



Kodi	Përshkrimi	Cmimi
4940	Grup dushi pa deviator	-

Demm-Grup dushi



Kodi	Përshkrimi	Cmimi
4950	Grup dushi me deviator	-

Panele Dielllore

Ngrohje & Ftohje

Hidraulike

Hidrosanitare

Aksesore të ndryshëm



LOE.Koleksion.

Një klasik i përjetshëm...
Funksional dhe praktik,
linja e tij e pastër dhe e
gjithanshme e lejon atë
të përshtatet lehtësisht në
"projekte banjosh" të
ndryshme.

Demm-Grup lavamani

Kodi	Përshkrimi	Cmimi
5610	Grup lavamani	-

Demm-Grup bide

Kodi	Përshkrimi	Cmimi
5620	Grup bide	-

Demm-Grup Vaske

Kodi	Përshkrimi	Cmimi
5600	Grup vaske	-

Demm-Grup dushi

Kodi	Përshkrimi	Cmimi
5630	Grup dushi	-

Demm-Grup dushi

Kodi	Përshkrimi	Cmimi
5640	Grup dushi pa deviator	-

Demm-Grup dushi

Kodi	Përshkrimi	Cmimi
5650	Grup dushi me deviator	-

Panele Dielllore

Ngrohje & Ftohje

Hidraulike

Hidrosanitare

Aksesore të ndryshëm



Relaksimi juaj, plotësia unike

Përjetoni relaksim tuaj me raportin e duhur cilësim... duke ruajtur linja të thjeshta dhe inovative, funksionale dhe aktuale, duke i dhënë banjës një kompletim unik.

Demm-Grup lavamani



Kodi	Përshkrimi	Cmimi
9810	Grup lavamani	-

Demm-Grup bide



Kodi	Përshkrimi	Cmimi
9820	Grup bide	-

Demm-Grup Vaske



Kodi	Përshkrimi	Cmimi
9800	Grup vaske	-

Demm-Grup vaske/dushi



Kodi	Përshkrimi	Cmimi
9805	Grup vaske / dushi	-

Demm-Grup dushi



Kodi	Përshkrimi	Cmimi
9830	Grup dushi	-

Demm-Grup dushi



Kodi	Përshkrimi	Cmimi
9833	Grup dushi	-

Demm-Grup dushi



Kodi	Përshkrimi	Cmimi
9840	Grup dushi pa deviator	-

Demm-Grup dushi



Kodi	Përshkrimi	Cmimi
9850	Grup dushi me deviator	-



Ne duhet të përmirësojmë ekuilibrin e kontrasteve, në kuzhinë dhe në jetë.

Një gamë e gjerë nga bota e kuzhinës, dizajne klasike dhe moderne, mjeshtëri dhe teknologji që bashkohen për të përmirësuar dhe kënaqur kërkesat e një mjedisi vazhdimisht në zhvillim. Projekte të studiuara, miksera gjithnjë e më eklektikë, duke ruajtur thjeshtësinë dhe funksionalitetin. E disponueshme në përfundime të ndryshme për të përmirësuar dhe bërë çdo kuzhinë harmonike.

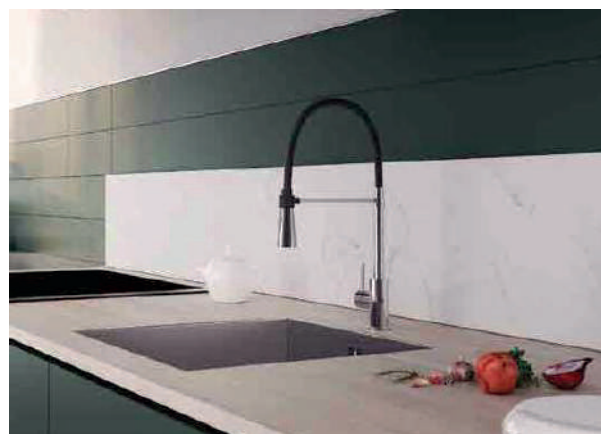

Demm-Grup lavapjate e zeze



Kodi	Përshkrimi	Cmimi
8084N	Grup lavapjate e zeze	-

Demm-Grup lavapjate e bardhe



Kodi	Përshkrimi	Cmimi
8084B	Grup lavapjate e bardhe	-

Demm-Grup lavapjate portokalli



Kodi	Përshkrimi	Cmimi
8084A	Grup lavapjate portokalli	-

Demm-Grup lavapjate e kuqe



Kodi	Përshkrimi	Cmimi
8084R	Grup lavapjate e kuqe	-

Demm-Grup lavapjate e zeze



Kodi	Përshkrimi	Cmimi
8085N	Grup lavapjate e zeze	-

Demm-Grup lavapjate e bardhe



Kodi	Përshkrimi	Cmimi
8085B	Grup lavapjate e bardhe	-

Demm-Grup lavapjate portokalli



Kodi	Përshkrimi	Cmimi
8085R	Grup lavapjate portokalli	-

Demm-Grup lavapjate gri



Kodi	Përshkrimi	Cmimi
8085G	Grup lavapjate gri	-

Demm-Grup lavapjate e zeze



Kodi	Përshkrimi	Cmimi
9660	Grup lavapjate e zeze	-

Panele Diellore

Ngrohje & Ftohje

Hidraulike

Hidrosanitare

Aksesore të ndryshëm

Demm-Grup lavapjate



Kodi	Përshkrimi	Cmimi
8174NU	Grup lavapjate	-

Demm-Grup lavapjate



Kodi	Përshkrimi	Cmimi
8174T	Grup lavapjate	-

Demm-Grup lavapjate



Kodi	Përshkrimi	Cmimi
8174	Grup lavapjate	-

Demm-Grup lavapjate



Kodi	Përshkrimi	Cmimi
5665	Grup lavapjate	-

Demm-Grup lavapjate



Kodi	Përshkrimi	Cmimi
5668	Grup lavapjate	-

Demm-Grup lavapjate



Kodi	Përshkrimi	Cmimi
5668	Grup lavapjate	-

Demm-Grup lavapjate



Kodi	Përshkrimi	Cmimi
8175	Grup lavapjate	-

Demm-Grup lavapjate



Kodi	Përshkrimi	Cmimi
8179	Grup lavapjate	-

Panele Diellore

Ngrohje & Ftohje

Hidraulike

Hidrosanitare

Aksesore të ndryshëm



Teknika, dizajn, instalim i lehtë

Demm ofron një gamë të gjerë artikujsh dushi të integruar me termostatikë dhe me një levë, të cilat kënaqin shijet më të kërkuara, duke kombinuar teknologjinë, dizajnin dhe lehtësinë e montimit në një produkt të vetëm. Linja të thjeshta që e bëjnë botën e banjës unike, forma katrore dhe të rrumbullakëta për t'iu përshtatur çdo dekori, një gamë e gjerë që i përgjigjet çdo dëshire.



Panele Dielllore

Demm-Grup dushi inkaso



Kodi	Përshkrimi	Cmimi
16010	Grup dushi inkaso	-

Demm-Grup dushi inkaso



Kodi	Përshkrimi	Cmimi
16020	Grup dushi inkaso	-

Demm-Grup dushi inkaso



Kodi	Përshkrimi	Cmimi
16030	Grup dushi inkaso	-

Ngrohje & Ftohje

Demm-Grup dushi inkaso



Kodi	Përshkrimi	Cmimi
16040	Grup dushi inkaso	-

Demm-Grup dushi inkaso e zeze



Kodi	Përshkrimi	Cmimi
16020NU	Grup dushi inkaso e zeze	-

Demm-Grup dushi inkaso e zeze



Kodi	Përshkrimi	Cmimi
16040NU	Grup dushi inkaso e zeze	-

Hidraulike

Demm-Grup dushi inkaso



Kodi	Përshkrimi	Cmimi
6770-3	Grup dushi inkaso me deviator	-

Demm-Grup dushi inkaso



Kodi	Përshkrimi	Cmimi
6771-3	Grup dushi inkaso me deviator	-

Demm-Grup dushi inkaso



Kodi	Përshkrimi	Cmimi
6772-3	Grup dushi inkaso me deviator	-

Hidrosanitare

Aksesore të ndryshëm

Demm-koke lavamani inkaso



Kodi	Përshkrimi	Cmimi
9516	Koke grupi lavamani katrore incaso	-

Demm-Krahe koke dushi



Kodi	Përshkrimi	Cmimi
6462NU	Krahe katrore koke dushi 40cm e zeze	-

Demm-Krahe koke dushi



Kodi	Përshkrimi	Cmimi
6462	Krahe katrore koke dushi incaso 40cm	-

Demm-Koke dushi



Kodi	Përshkrimi	Cmimi
353NU	Koke dushi e zeze mat	-

Demm-mbajtese koke dushi



Kodi	Përshkrimi	Cmimi
4263	Mbajtese koke dushi	-

Demm-Krahe koke dushi



Kodi	Përshkrimi	Cmimi
6460NU	Krahe koke dushi 40cm e zeze	-

Demm-Koke dushi



Kodi	Përshkrimi	Cmimi
6471NU	Koke dushi 30x30 mat e zeze	-

Demm-Koke dushi



Kodi	Përshkrimi	Cmimi
6471	Koke dushi 25x25	-

Demm-mbajtese koke dushi



Kodi	Përshkrimi	Cmimi
4262NU	Mbajtese koke dushi e zeze e rrumbullaket	-

Demm-Krahe koke dushi



Kodi	Përshkrimi	Cmimi
6460	Krahe koke dushi incaso e rrumbullaket 40cm	-

Demm-koke dushi



Kodi	Përshkrimi	Cmimi
6470NU	Koke dushi e rrumbullaket 30 cm e zeze	-

Demm-Koke dushi



Kodi	Përshkrimi	Cmimi
6471	Koke dushi 35x35	-

Demm-Koke dushi



Kodi	Përshkrimi	Cmimi
6453	Koke dushi e rrumbullaket D20	-

Demm-Koke dushi



Kodi	Përshkrimi	Cmimi
6452	Koke dushi e katrore 20x20	-

Demm-Koke dushi



Kodi	Përshkrimi	Cmimi
426	Koke dushi kundra smercit	-

Demm-Koke dushi



Kodi	Përshkrimi	Cmimi
407	Koke dushi ABS kundra smercit	-

Demm-Koke dushi



Kodi	Përshkrimi	Cmimi
408	Koke dushi ABS me buton kundra smercit	-

Demm-Koke dushi



Kodi	Përshkrimi	Cmimi
372	Koke dushi ABS me buton me grep	-

Demm-Koke dushi



Kodi	Përshkrimi	Cmimi
443	Koke dushi ABS me dy funksione kundra smercit	-

Demm-Koke lavamani



Kodi	Përshkrimi	Cmimi
6816	Koke grupi lavamani i rrumbullaket incaso	-

Demm-Krahe Koke dushi



Kodi	Përshkrimi	Cmimi
6465	Krahe koke dushi e rrumbullaket 30cm	-

Demm-Krahe Koke dushi



Kodi	Përshkrimi	Cmimi
6474	Krahe koke dushi inkaso katrore 35cm	-

Demm-Koke dushi



Kodi	Përshkrimi	Cmimi
6495	Koke dushi bronxi kundra smercit me funksioni hedhje uje shiu	-

Demm-Koke dushi



Kodi	Përshkrimi	Cmimi
6470	Koke dushi e rrumbullaket D25	-

Panele Diellore

Ngrohje & Ftohje

Hidraulike

Hidrosanitare

Aksesore të ndryshëm



SHOWER COLUMN. katalog.

Harmonike ose lineare, jepini vetes relaksim absolut

Dizajni dhe cilësia karakterizojnë kolonat e dushit të propozuara, harmonike dhe lineare, manuale apo termostatike... Një gamë e gjerë që plotëson çdo nevojë, i jep vetes relaksim absolut. E hollë dhe novatore, moderne dhe klasike, elegante dhe e përshtatshme për çdo dush. Teknologji që shndërrohet në art për ta kthyer një dush të thjeshtë në emocion të pastër.



Panele Dielllore

Ngrohje & Ftohje

Hidraulike

Hidrosanitare

Aksesore të ndryshëm

Panele Diellore

Demm-Grup dushi + kollone



Kodi	Përshkrimi	Cmimi
15429	Grup dushi + kollone	-

Demm-Grup dushi + kollone



Kodi	Përshkrimi	Cmimi
17841	Grup dushi + kollone	-

Demm-Grup dushi termostatik + kollone



Kodi	Përshkrimi	Cmimi
17862	Grup dushi termostatik + kollone	-

Ngrohje & Ftohje

Demm-Grup dushi termostatik + kollone



Kodi	Përshkrimi	Cmimi
15406NU	Grup dushi termostatik + kollone	-

Demm-Grup dushi termostatik + kollone



Kodi	Përshkrimi	Cmimi
15496	Grup dushi termostatik + kollone	-

Demm-Grup dushi + kollone



Kodi	Përshkrimi	Cmimi
15871	Grup dushi + kollone	-

Hidraulike

Demm-Grup dushi termostatik + kollone



Kodi	Përshkrimi	Cmimi
15495	Grup dushi termostatik + kollone	-

Demm-Grup dushi + kollone



Kodi	Përshkrimi	Cmimi
15497	Grup dushi + kollone	-

Demm-Grup dushi + kollone



Kodi	Përshkrimi	Cmimi
15431	Grup dushi + kollone	-

Hidrosanitare

Aksesore të ndryshëm



SERIA SHOWER COLUMN

Demm-Grup dushi + kollone



Kodi	Përshkrimi	Cmimi
16315	Grup dushi + kollone	-

Demm-Grup dushi + kollone



Kodi	Përshkrimi	Cmimi
16310	Grup dushi + kollone	-

Demm-Grup dushi + kollone



Kodi	Përshkrimi	Cmimi
16320	Grup dushi + kollone	-

Demm-Grup dushi + kollone



Kodi	Përshkrimi	Cmimi
17000X	Grup dushi + kollone	-

Demm-Grup dushi + kollone



Kodi	Përshkrimi	Cmimi
17450N	Grup dushi + kollone	-

Demm-Grup dushi termostatik + kollone



Kodi	Përshkrimi	Cmimi
15870	Grup dushi termostatik + kollone	-

Demm-Grup dushi termostatik + kollone



Kodi	Përshkrimi	Cmimi
15872	Grup dushi termostatik + kollone	-

Demm-Grup dushi + kollone



Kodi	Përshkrimi	Cmimi
17861	Grup dushi + kollone	-

Demm-Grup dushi + kollone



Kodi	Përshkrimi	Cmimi
17436	Grup dushi + kollone	-

Panele Dielllore

Ngrohje & Ftohje

Hidraulike

Hidrosanitare

Aksesore të ndryshëm

Demm-Koke dushi



Kodi	Përshkrimi	Cmimi
442	Koke dushi	-

Demm-Koke dushi



Kodi	Përshkrimi	Cmimi
421	Koke dushi	-

Demm-zorre dushi



Kodi	Përshkrimi	Cmimi
196LN	Zorre dushi	-

Demm-Krahe Koke dushi



Kodi	Përshkrimi	Cmimi
6468	Krahe koke dushi 15cm i zi	-

Demm-Koke dushi



Kodi	Përshkrimi	Cmimi
354	Koke dushi	-

Demm-Koke dushi



Kodi	Përshkrimi	Cmimi
6587	Koke dushi katrore	-

Demm-Koke dushi



Kodi	Përshkrimi	Cmimi
6583	Koke dushi e rrumbullaket	-

Demm-Koke dushi



Kodi	Përshkrimi	Cmimi
354NU	Koke dushi e zeze mat	-

Demm-Krahe Koke dushi



Kodi	Përshkrimi	Cmimi
6487	Krahe koke dushi 9cm	-



SERIA SHOWER COLUMN

Demm-Krahe Koke dushi



Kodi	Përshkrimi	Cmimi
6468	Krahe koke dushi 15cm	-

Demm-Krahe Koke dushi



Kodi	Përshkrimi	Cmimi
6467	Krahe koke dushi katrore 15cm	-

Demm-Rubinet-mbajtese Koke dushi



Kodi	Përshkrimi	Cmimi
3377	Rubinet - mbajtese koke dushi	-

Demm-Rubinet-mbajtese Koke dushi



Kodi	Përshkrimi	Cmimi
3370	Rubinet - mbajtese koke dushi	-

Demm- Koke dushi



Kodi	Përshkrimi	Cmimi
6588	Koke dushi e rrumbullaket	-

Demm- Koke dushi



Kodi	Përshkrimi	Cmimi
6586	Koke dushi e rrumbullaket	-

Demm-Rubinet-mbajtese Koke dushi



Kodi	Përshkrimi	Cmimi
4262	Rubinet - mbajtese koke dushi	-

Demm- Koke dushi



Kodi	Përshkrimi	Cmimi
6584	Koke dushi e rrumbullaket	-

Demm- Koke dushi



Kodi	Përshkrimi	Cmimi
353	Koke dushi katrore	-

Demm-Mbajtese Koke dushi



Kodi	Përshkrimi	Cmimi
4264	Mbajtese koke dushi	-

Demm- Koke dushi



Kodi	Përshkrimi	Cmimi
6587	Koke dushi katrore 25x25	-

Demm- Koke dushi



Kodi	Përshkrimi	Cmimi
348	Koke dushi	-

Panele Diellore

Ngrohje & Ftohje

Hidraulike

Hidrosanitare

Aksesorë të ndryshëm



SERIA SHOWER COLUMN

Demm- Koke dushi



Kodi	Përshkrimi	Cmimi
6585	Koke dushi katrore 25x25	-

Demm- Koke dushi



Kodi	Përshkrimi	Cmimi
6571	Koke dushi katrore 25x25	-

Demm- Koke dushi



Kodi	Përshkrimi	Cmimi
6570	Koke dushi rrethore D25	-

Demm- brryl bronxi per zorre dushi



Kodi	Përshkrimi	Cmimi
4256	Brryl broxi per zorre dushi	-

Demm- Koke dushi



Kodi	Përshkrimi	Cmimi
4202	Koke dushi	-

Demm- Koke dushi



Kodi	Përshkrimi	Cmimi
6403	Koke me hidomasazh per grup dushi incaso	-

Demm- Pilete klik-klak



Kodi	Përshkrimi	Cmimi
162	Pilete klik-klak	-

Demm- Koke dushi



Kodi	Përshkrimi	Cmimi
6401	Koke katrore me hidomasazh per grup dushi incaso	-

Demm- Koke dushi



Kodi	Përshkrimi	Cmimi
422	Koke dushi katrore	-

Demm- Zorre dushi



Kodi	Përshkrimi	Cmimi
196G	Zorre dushi 150cm	-

Demm- Zorre dushi



Kodi	Përshkrimi	Cmimi
196N	Zorre dushi 150-200cm	-

Demm- Zorre dushi



Kodi	Përshkrimi	Cmimi
196I	Zorre dushi plastike 150cm	-

Panele Diellore

Ngrohje & Ftohje

Hidraulike

Hidrosanitare

Aksesore të ndryshëm



SERIA SHOWER COLUMN

Demm- Aksesori incaso



Kodi	Përshkrimi	Cmimi
ZT01-45	Mbajtese peshqiri	-

Demm- Aksesori incaso



Kodi	Përshkrimi	Cmimi
ZT03	Mbajtese peshqiri	-

Demm- Aksesori incaso



Kodi	Përshkrimi	Cmimi
ZT05	Mbajtese peshqiri grep dopio	-

Demm- Aksesori incaso



Kodi	Përshkrimi	Cmimi
ZT06	Mbajtese gote	-

Demm- Aksesori incaso



Kodi	Përshkrimi	Cmimi
ZT07	Mbajtese sapuni	-

Demm- Aksesori incaso



Kodi	Përshkrimi	Cmimi
ZT09	Mbajtese leter higjenike	-

Demm- Aksesori incaso



Kodi	Përshkrimi	Cmimi
ZT10	Mbajtese furce wc-je	-

Demm- Aksesori incaso



Kodi	Përshkrimi	Cmimi
BL01-45	Mbajtese peshqiri 45CM	-

Demm- Aksesori incaso



Kodi	Përshkrimi	Cmimi
BL03	Mbajtese peshqiri dopio	-

Demm- Aksesori incaso



Kodi	Përshkrimi	Cmimi
BL05	Mbajtese gote mat	-

Demm- Aksesori incaso



Kodi	Përshkrimi	Cmimi
BL06	Mbajtese sapuni mat	-

Demm- Aksesori incaso



Kodi	Përshkrimi	Cmimi
BL08	Mbajtese peshqiri grep	-

Panele Diellore

Ngrohje & Ftohje

Hidraulike

Hidrosanitare

Aksesore të ndryshëm

Demm- Aksesori incaso



Kodi	Përshkrimi	Cmimi
BL09	Mbajtese leter higjenike	-

Demm- Aksesori incaso



Kodi	Përshkrimi	Cmimi
BL11	Mbajtese furce wc-je	-

Demm- Aksesori incaso



Kodi	Përshkrimi	Cmimi
4257	Mbajtese telefoni	-

Demm-Krahe Koke dushi



Kodi	Përshkrimi	Cmimi
6461	Krahe koke dushi inkaso D32, 40CM	-

Demm-Koke dushi



Kodi	Përshkrimi	Cmimi
435	Koke dushi	-

Demm- Aksesori incaso



Kodi	Përshkrimi	Cmimi
ZT01-06	Mbajtese peshqiri	-

Demm-Grup dushi + kollone



Kodi	Përshkrimi	Cmimi
16300	Grup dushi + kollone	-

Demm-Koke dushi



Kodi	Përshkrimi	Cmimi
450	Koke dushi	-





Hydro BS - Vaska

Hydros-BS – Vaske me hidromasazh



Hydros-BS – Vaske me hidromasazh



Panele Diellore

Ngrohje & Ftohje

Hidraulike

Hidrosanitare

Aksesore të ndryshëm

Kodi	Përshkrimi	Cmimi
Melisa 18080	Hydro BS – Melisa vaske me hidromasazh 180x80	-

Kodi	Përshkrimi	Cmimi
Mirto 18080	Hydro BS – Mirto vaske me hidromasazh 180x80	-

Hydros-BS – Vaske e thjeshte



Hydros-BS – Vaske hidro/aeromasazh



Kodi	Përshkrimi	Cmimi
Simona 17578	Hydro BS – Simona vaske plastike e thjeshte 175x78	-

Kodi	Përshkrimi	Cmimi
Simona 17578H	Hydro BS – Simona vaske me hidro/aeromasazh 175x78	-

Hydros-BS – Vaske e thjeshte



Hydros-BS – Vaske e thjeshte



Kodi	Përshkrimi	Cmimi
Simona 17578B	Hydro BS – Simona plastike e thjeshte bezhe,175x78	-

Kodi	Përshkrimi	Cmimi
Klio 17070	Hydro BS – Klio vaske plastike e thjeshte 170x70	-



Hydro BS - Vaska

Hydros-BS – Vaske hidro/aeromasazh



Hydros-BS – Vaske hidro/aeromasazh



Kodi	Përshkrimi	Cmimi
Arieta 145	Hydro BS – Arieta vaske me hidro/aeromasazh 145x145	-

Kodi	Përshkrimi	Cmimi
Aria 212160	Hydro BS – Aria vaske me hidro/aeromasazh+drita 2.12x1.6 m	-

Hydros-BS – Vaske hidro/aeromasazh



Hydros-BS – Vaske hidro/aeromasazh



Kodi	Përshkrimi	Cmimi
Karla 190120	Hydro BS – Karla vaske me hidro/aeromasazh+drita 190x120	-

Kodi	Përshkrimi	Cmimi
Beatriks 190100	Hydro BS – Beatriks vaske me hidro/aeromasazh 190x100	-

Panele Dielllore

Ngrohje & Ftohje

Hidraulike

Hidrosanitare

Aksesore të ndryshëm



Pasqyrë Led

Pasqyrë Led



Kodi	Përmasat	Cmimi
MO24.B	60x80 (V)	-
MO24.C	90x60 (H)	-

Pasqyrë Led



Kodi	Përmasat	Cmimi
MO25.C	60x80 (V+H)	-
MO25.E	90x60 (V+H)	-

Pasqyrë Led



Kodi	Përmasat	Cmimi
MO26.A	60x80 (V + H)	-

Pasqyrë Led



Kodi	Përmasat	Cmimi
MO27.A	60x80(V+H)	-
MO27.B	100x70(V+H)	-

Pasqyrë Led



Kodi	Përmasat	Cmimi
MO31.A	60x80 (H+V)	-

Pasqyrë Led



Kodi	Përmasat	Cmimi
MO32.A	60x80 (H+V)	-

Pasqyrë Led



Kodi	Përmasat	Cmimi
MO32.B	90x60(H+V)	-

Pasqyrë Led



Kodi	Përmasat	Cmimi
MO35. A	100X75	-

Pasqyrë Led



Kodi	Përmasat	Cmimi
MO28.A	80x60 2 fasce Retro(H+V)	-

Panele Diellore

Ngrohje & Ftohje

Hidraulike

Hidrosanitare

Aksesorë të ndryshëm

Pasqyrë Led

Panele Diellore

Pasqyrë Led



Kodi	Përmasat	Cmimi
MO29.A	60x80 (H+V)	-

Pasqyrë Led



Kodi	Përmasat	Cmimi
MO30.A	90x50 (H+V)	-

Pasqyrë Led



Kodi	Përmasat	Cmimi
MO25.G	100x70 (V+H)	-

Ngrohje & Ftohje

Pasqyrë Led



Kodi	Përmasat	Cmimi
MO25.L	120x70 (V+H)	-

Pasqyrë Led



Kodi	Përmasat	Cmimi
ART1001. B	90X70 (V+H)	-

Pasqyrë Led



Kodi	Përmasat	Cmimi
ART1001. E	120X70 (V+H)	-

Hidraulike

Pasqyrë Led



Kodi	Përmasat	Cmimi
ART1036. B	90X70 (V+H)	-

Pasqyrë Led



Kodi	Përmasat	Cmimi
ART1036. E	120X70 (V+H)	-

Pasqyrë Led



Kodi	Përmasat	Cmimi
ART 1038. C	80	-

Hidrosanitare

Aksesore të ndryshëm

Pasqyrë Led dhe Aksesorë

Platex-Aksesore banjo per mbajtese peshqiri



Kodi	Përmasat	Cmimi
PL4.10	e kromuar, grep	-

Platex-Aksesore banjo per mbajtese letre higjenike



Kodi	Përmasat	Cmimi
PL5.10	e kromuar	-

Platex-Aksesore banjo per mbajtese peshqiri



Kodi	Përmasat	Cmimi
PL10.10	50 cm e kromuar	-

Aksesore banjo per mbajtese furce wc-je



Kodi	Përmasat	Cmimi
PL15.10	inox e kromuar	-

Aksesore banjo per mbajtese peshqiri



Kodi	Përmasat	Cmimi
PL11.10	e rrumbullaket	-

Aksesore banjo-mbajtese gote



Kodi	Përmasat	Cmimi
MO1.10	mbajtese gote	-

Aksesore banjo-mbajtese sapuni



Kodi	Përmasat	Cmimi
MO2.10	mbajtese sapuni	-

Moon- Aksesore banjo per varje peshqiri



Kodi	Përmasat	Cmimi
MO4.10	grep	-

Aksesore banjo-mbajtese letre higjenike



Kodi	Përmasat	Cmimi
MO5C.10	me kapak e kromuar	-

Moon- Aksesore banjo per mbajtese peshqiri



Kodi	Përmasat	Cmimi
MO10.10	50 cm e kromuar	-

Moon- Aksesore banjo per mbajtese furce wc-je



Kodi	Përmasat	Cmimi
MO15.10	inox e kromuar	-

Moon- Aksesore banjo per mbajtese peshqiri



Kodi	Përmasat	Cmimi
MO11.10	e rrumbullaket	-

Pasqyrë Led dhe Aksesorë

Panele Diellore

Aksesore banjo-mbajtese gote



Kodi	Përmasat	Cmimi
ML1.10	e kromuar,xham	-

Aksesore banjo-mbajtese sapuni



Kodi	Përmasat	Cmimi
ML2.10	e kromuar,xham	-

Aksesore banjo per varje peshqiri ,grip



Kodi	Përmasat	Cmimi
ML4.10	grip	-

Ngrohje & Ftohje

Aksesore banjo-mbajtese letre higjienike



Kodi	Përmasat	Cmimi
ML5.10	e kromuar	-

Aksesore banjo per mbajtese peshqiri



Kodi	Përmasat	Cmimi
ML10.10	50 cm e kromuar	-

Aksesore banjo per mbajtese furce wc-je



Kodi	Përmasat	Cmimi
ML15.10	E kromuar	-

Hidraulike

Aksesore banjo per mbajtese peshqiri



Kodi	Përmasat	Cmimi
ML11.10	E rrumbullaket	-

Hidrosanitare

Aksesore të ndryshëm

Kaseta metalike dhe aksesorë

Kasetë metalike



Kodi	Përmasat	Cmimi
HE004	45x35	-
HE005	45x40	-
HE006	45x50	-
HE007	45x55	-

Kasetë metalike



Kodi	Përmasat	Cmimi
HE008	45x60	-
HE009	45x70	-
HE011	45x45	-
HE010	45x80	-

Kasetë metalike



Kodi	Përmasat	Cmimi
FB050	60x45me buton	-
HE012	47x40 me buton	-
HE013	47x50 me buton	-
HE014	47x60 me buton	-
HE015	47x70 me buton	-

Kaset plastike e zeze+kap



Kodi	Përmasat	Cmimi
KOR001	i bardhe me ajrim 40x40	-
KOR002	i bardhe me ajrim 40x50	-
KOR003	i bardhe me ajrim 40x60	-

Gozhd Betoni M6 8x18



Kodi	Përmasat	Cmimi
HFX35GR8	M6 8x18	-

Kaset plastike e bardhe me ajrim



Kodi	Përmasat	Cmimi
KOR004	e bardhe me ajrim 35x35	-

Fasheta hidraulike



Kodi	Përmasat	Cmimi
HFX35GR8	Fasheta hidraulike	-

Spango Hidraulike Sealit



Kodi	Përmasat	Cmimi
082-00-01	160 m	-

Loxel 53x14



Kodi	Përmasat	Cmimi
HFX35GR8	53x14	-

Panele Diellore

Ngrohje & Ftohje

Hidraulike

Hidrosanitare

Aksesore të ndryshëm

Antifrizë, Aksesorë

Antifrizë 1 lt-60°C



Kodi	Përmasat	Cmimi
102917	1 lt-60°C	-

Antifrizë Hidrotherm



Kodi	Përmasat	Cmimi
10404	1 lt-49°C	-

Acid zhblllokues Fere



Kodi	Përmasat	Cmimi
10501	0.5 lt	-
10502	1 lt	-

Kanaline niveluese rrotulluese me trup plastike



Kodi	Përmasat	Cmimi
MTLD5G-40	Ø 50, zgare inoksi-40 cm	-
MTLD5G-50	Ø 50, zgare inoksi-50 cm	-
MTLD5G-60	Ø 50, zgare inoksi-60 cm	-

Kanaline niveluese me trup i 50plastike f



Kodi	Përmasat	Cmimi
MTLD1-40	Ø 50, zgare inoksi-50 cm	-
MTLD1-50	Ø 50, zgare inoksi-50 cm	-

Kanaline niveluese dekoruese fi 50 -40 cm



Kodi	Përmasat	Cmimi
MTLD-7-40	Ø 50 -40 cm	-
MTLD-7-50	Ø 50 -40 cm	-

Sifon lavamani plastik 32x1.1/4"



Kodi	Përmasat	Cmimi
FP-114-32	32x1.1/4"	-

Sifon lavamani plastik 40/50x1.1/4"



Kodi	Përmasat	Cmimi
FP-114-45	40/50x1.1/4"	-

Sifon lavamani plastik 32x1.1/4"+pilet 65mm



Kodi	Përmasat	Cmimi
L114-32	32x1.1/4"+pilet 65mm	-

Gomine wc-je firzamonik 40cm,110mm



Kodi	Përmasat	Cmimi
WFC-40	40cm,110mm	-

Gomine wc-je firzamonik 50cm,110mm



Kodi	Përmasat	Cmimi
WFC-50	50cm,110mm	-

Brryl gomine wc-je firzamonik 50cm,110mm



Kodi	Përmasat	Cmimi
DWFC-50	50cm,110mm	-

CR Smart dhe HYDROSPIRAL

CR-Galixhan universal 3/8 per kaset inkaso



CR-Galixhan universal 3/8 per kaset inkaso DP



CR-Mekanizem wc-je monoblok 3/8-Da



Kodi	Përmasat	Cmimi
1513	3/8 per kaset inkaso	-

Kodi	Përmasat	Cmimi
1514L	3/8 per kaset inkaso DP	-

Kodi	Përmasat	Cmimi
1402	3/8-Da	-

CR-Mekanizem wc-je monoblok 3/8-Dp



CR-Sifon lavapjate tek D40,1.1/2



CR-Sifon lavapjate dopjo D40,1.1/2



Kodi	Përmasat	Cmimi
1403	3/8-Dp	-

Kodi	Përmasat	Cmimi
C1UW	tek D40,1.1/2	-

Kodi	Përmasat	Cmimi
C2UW	dopjo D40,1.1/2	-

CR-Sifon lavamani plastik i kromuar fi 32x1.1/4



CR-Sifon lavapjate firzamonike dopjo 1.1/2



CR-Sifon lava/lavapjate 32x40 ,1.1/2



Kodi	Përmasat	Cmimi
C1B2-M	I kromuar fi 32x1.1/4	-

Kodi	Përmasat	Cmimi
2XY	dopjo 1.1/2	-

Kodi	Përmasat	Cmimi
C1X8	32x40 ,1.1/2	-

CR-Sifon lavamani 32x40 ,1.1/4

Cfryres 12 bar 1/2 F

 Kondravalvul dushi 12-14 bar **NEW**

Kodi	Përmasat	Cmimi
C1X4	32x40 ,1.1/4	-

Kodi	Përmasat	Cmimi
25004	12 bar 1/2 F	-

Kodi	Përmasat	Cmimi
25011	12-14 bar	-

Telefon me 3 opsione Hydrospiral

Telefon me 3 opsione Hydrospiral

Telefon me 3 opsione Hydrospiral



Kodi	Përmasat	Cmimi
53001	me 3 opsione	-

Kodi	Përmasat	Cmimi
53002	me 3 opsione	-

Kodi	Përmasat	Cmimi
53007	me 3 opsione	-

Panele Diellore

Ngrohje & Ftohje

Hidraulike

Hidrosanitare

Aksesore të ndryshëm

CR Smart dhe HYDROSPIRAL

Zorr dushi 1.5 met Hydrospiral



Kodi	Përmasat	Cmimi
51001	1.5 met Hydrospiral	-

Zorr dushi 2 met Hydrospiral



Kodi	Përmasat	Cmimi
51002	2 met Hydrospiral	-

Zorr dushi 1.5 met+telefon+ganxh Hydrospiral



Kodi	Përmasat	Cmimi
51005	1.5 met+telefon+ganxh	-

Fresibel Hydrospiral



Kodi	Përmasat	Cmimi
48001	50 cm 3/4 F+m Hydrospiral	-
48002	60 cm 3/4 F+m Hydrospiral	-
48005	50 cm 1" F+m Hydrospiral	-
48006	60 cm 1" F+m Hydrospiral	-

Fresibel Hydrospiral



Kodi	Përmasat	Cmimi
42003	30 cm f+m 1/2x1/2	-
42005	40 cm f+m 1/2x1/2	-
42007	50 cm f+m 1/2x1/2	-
42008	60 cm f+m 1/2x1/2	-

Fresibel Hydrospiral



Kodi	Përmasat	Cmimi
42018	30 cm f+f 1/2x1/2	-
42020	40 cm f+f 1/2x1/2	-
42022	50 cm f+f 1/2x1/2	-
42023	60 cm f+f 1/2x1/2	-

Hidroflex

Fresibel Hidroflex



Kodi	Përmasat	Cmimi
HFX20FM	20 cm f+m 1/2x1/2	-
HFX30FM	30 cm f+m 1/2x1/2	-
HFX40FM	40 cm f+m 1/2x1/2	-
HFX50FM	50 cm f+m 1/2x1/2	-
HFX60FM	60 cm f+m 1/2x1/2	-
HFX70FM	70 cm f+m 1/2x1/2	-
HFX80FM	80 cm f+m 1/2x1/2	-
HFX90FM	90 cm f+m 1/2x1/2	-
HFX100FM	100 cm f+m 1/2x1/2	-

Fresibel Hidroflex



Kodi	Përmasat	Cmimi
HFX20FF	20 cm f+f 1/2x1/2	-
HFX30FF	30 cm f+f 1/2x1/2	-
HFX40FF	40 cm f+f 1/2x1/2	-
HFX50FF	50 cm f+f 1/2x1/2	-
HFX60FF	60 cm f+f 1/2x1/2	-
HFX70FF	70 cm f+f 1/2x1/2	-
HFX80FF	80 cm f+f 1/2x1/2	-
HFX90FF	90 cm f+f 1/2x1/2	-
HFX100FF	100 cm f+f 1/2x1/2	-

Fresibel Hidroflex



Kodi	Përmasat	Cmimi
HFX40GR1.2	Grupi 40 cm 1/2x1.2	-
HFX50GR1.2	Grupi 50 cm 1/2x1.2	-
HFX60GR1.2	Grupi 60 cm 1/2x1.2	-

Fresibel Hidroflex



Kodi	Përmasat	Cmimi
HFX40GR4	Grupi 40 cm 1/2x4	-
HFX50GR4	Grupi 50 cm 1/2x4	-
HFX60GR4	Grupi 60 cm 1/2x4	-
HFX50GR8	Grupi 50 cm 1/2x8	-

Fresibel Hidroflex



Kodi	Përmasat	Cmimi
HFX40F1/2F3/8	40 cm 1/2f x3/8f	-
HFX30F1/2F3/8	30 cm 1/2f x3/8f	-
HFX50F1/2F3/8	50 cm 1/2f x3/8f	-
HFX60F1/2F3/8	60 cm 1/2f x3/8f	-
HFX70F1/2F3/8	70 cm 1/2f x3/8f	-

Fresibel Hidroflex



Kodi	Përmasat	Cmimi
HFX30F3/8F3/8	30 cm 3/8f x 3/8f	-
HFX40F3/8F3/8	40 cm 3/8f x3/8f	-
HFX50F3/8F3/8	50 cm 3/8f x3/8f	-
HFX60F3/8F3/8	60 cm 3/8f x3/8f	-
HFX70F3/8F3/8	70 cm 3/8f x3/8f	-

Fresibel Hidroflex



Kodi	Përmasat	Cmimi
HFX30F3/8M3/8	30 cm 3/8f x3/8m	-
HFX40F3/8M3/8	40 cm 3/8f x3/8m	-
HFX50F3/8M3/8	50 cm 3/8f x3/8m	-
HFX60F3/8M3/8	60 cm 3/8f x3/8m	-

Fresibel Hidroflex



Kodi	Përmasat	Cmimi
HFX35GR8	Grupi 35 cm1/2x8	-
HFX40GR1.2/3/8	Grupi40 cm3/8x1.2	-
HFX50GR1.2/3/8	Grupi50 cm3/8x1.2	-

Panele Dielllore

Ngrohje & Ftohje

Hidraulike

Hidrosanitare

Aksesore të ndryshëm

Rezistenca dushi elektrik dhe paneli diellor

Panele Diellore

Rezistencë bolieri Thermowatt



Kodi	Përmasat	Cmimi
DO89	3.5 kw MF (1.1/2)	-

Rezistencë bolieri



Kodi	Përmasat	Cmimi
LAT23	4 kw MF (1.1/2)	-

Rezistencë bolieri 6 kw 3F (1.1/2)



Kodi	Përmasat	Cmimi
LAT20	6 kw 3F (1.1/2)	-

Ngrohje & Ftohje

Rezistencë bolieri



Kodi	Përmasat	Cmimi
LAT21	9 kw 3F (1.1/2)	-

 Rezistencë dushi diellor inoks
(cod 107505)

Kodi	Përmasat	Cmimi
VEN041	inoks M8 fi 140, 3.5 kw	-

 Rezistencë dushi diellor
(cod 107505)

Kodi	Përmasat	Cmimi
VEN040	M8 fi 140, 3.5 kw	-

Hidraulike

Rezistencë dushi elektrik Hidrotherm



Kodi	Përmasat	Cmimi
102305	2 kw	-

 Rezistencë dushi elektrik V me 8 vrima DRALL-
(cod 21100120)

Kodi	Përmasat	Cmimi
DH003	Fi 120 3 kw	-

 Rezistencë dushi elektrik V+H me
5 vrima DRALL

Kodi	Përmasat	Cmimi
DH005	Fi 120 3.5 kw	-

Hidrosanitare

 Rezistencë Vertikal me 8 vrima & paneli
120&150 lt

Kodi	Përmasat	Cmimi
VEN046	Fi 120 4 kw	-

 Rezistencë me serbetine per panel diellor,
(cod 21400041)

Kodi	Përmasat	Cmimi
DH013	M8 4 kw fi 120-85 cm(200 lt)	-

 Rezistencë me serbetine per panel diellor,
(cod 21400077)

Kodi	Përmasat	Cmimi
VEN046	M8 4 kw fi 140-85 cm(200 lt)	-

Aksesore të ndryshëm

shkripezues, gomina

Doctoris - Rezistence



Kodi	Përshkrimi	Cmimi
DO89	Do-Rezistence per bolier 3.5 kw MF (1.1/2) Thermowatt	-

Pilet banje katrore, DA fi 50 me zgare plastike



Kodi	Përmasat	Cmimi
M-10	Ø50-zgare plastike 10x10 mm	-

Pilet banje katrore, DA fi 50 me zgare inoksi



Kodi	Përmasat	Cmimi
M-10-A	Ø50-zgare inoksi 10x10 mm	-

Pilet banje katrore, DA fi 50 -design 10x10 mm



Kodi	Përmasat	Cmimi
MSY-10	Ø50 -design 10x10 mm	-

Zgar inx Hydrospiral e rumbullaket



Kodi	Përmasat	Cmimi
56009	me mbyllje fi100 (90gr)	-
56010	me mbyllje fi120 (212gr)	-

Zgar inx Hydrospiral katrore



Kodi	Përmasat	Cmimi
56011	me mbyllje fi100 (147gr)	-
56012	me mbyllje fi120 (245gr)	-

Zgare inoksi me mbyllje-me klik-klak



Kodi	Përmasat	Cmimi
460-00-07	fi 120 (katrore)	-

Shkripezues Dushi Diellor



Kodi	Përmasat	Cmimi
-	fi 22x40	-
-	fi 22x15	-

Gomina Rezistence fi 140,e zeze



Kodi	Përmasat	Cmimi
-	fi 140,e zeze	-

Panele Diellore

Ngrohje & Ftohje

Hidraulike

Hidrosanitare

Aksesore të ndryshëm



TEA – Kanalina plastike

OMP-tea kanalina plastike fi-50



Kodi	Përshkrimi	Cmimi
943.506.8	TEA-Kanaline plastike fi 50 me zgare inoksi Std Light-400mm	-
943.706.8	TEA-Kanaline plastike fi 50 me zgare inoksi Std Light-500mm	-
943.806.8	TEA-Kanaline plastike fi 50 me zgare inoksi Std Light-600mm	-
943.906.8	TEA-Kanaline plastike fi 50 me zgare inoksi Std Light-700mm	-
943.206.8	TEA-Kanaline plastike fi 50 me zgare inoksi Std Light-800mm	-

OMP-tea kanalina plastike fi-50



Kodi	Përshkrimi	Cmimi
943.704.8.C	TEA-Kanaline plastike fi 50 me zgare inoksi Line C-500mm	-
943.804.8.C	TEA-Kanaline plastike fi 50 me zgare inoksi Line C-600mm	-
943.904.8.C	TEA-Kanaline plastike fi 50 me zgare inoksi Line C-700mm	-
-	-	-
-	-	-

OMP-tea kanalina plastike fi-50



Kodi	Përshkrimi	Cmimi
943.701.8.C	TEA-Kanaline plastike fi 50 me zgare inoksi Waves C-500mm	-
943.801.8.C	TEA-Kanaline plastike fi 50 me zgare inoksi Waves C-600mm	-
943.901.8.C	TEA-Kanaline plastike fi 50 me zgare inoksi Waves C-700mm	-
-	-	-
-	-	-

OMP-tea kanalina plastike fi-50



Kodi	Përshkrimi	Cmimi
943.702.8.C	TEA-Kanaline plastike fi 50 me zgare inoksi Twist C-500mm	-
943.802.8.C	TEA-Kanaline plastike fi 50 me zgare inoksi Twist C-600mm	-
943.902.8.C	TEA-Kanaline plastike fi 50 me zgare inoksi Twist C-700mm	-

OMP-tea kanalina plastike fi-50



Kodi	Përshkrimi	Cmimi
943.707.8.C	TEA-Kanaline plastike fi 50 me zgare inoksi Fence C-500mm	-
943.807.8.C	TEA-Kanaline plastike fi 50 me zgare inoksi Fence C-600mm	-
943.907.8.C	TEA-Kanaline plastike fi 50 me zgare inoksi Fence C-700mm	-

OMP-tea kanalina plastike fi-50



Kodi	Përshkrimi	Cmimi
943.708.8.C	TEA-Kanaline plastike fi 50 me zgare inoksi Grated C-500mm	-
943.808.8.C	TEA-Kanaline plastike fi 50 me zgare inoksi Grated C-600mm	-
943.908.8.C	TEA-Kanaline plastike fi 50 me zgare inoksi Grated C-700mm	-

Panelle Diellore

Ngrohje & Ftohje

Hidraulike

Hidrosanitare

Aksesore të ndryshëm



TEA – Pilet

OMP-tea pilet lavamani



Kodi	Përshkrimi	Cmimi
147.355.5	TEA-Pilet lavamani bronxi i kromuar Lanterna fi 63x1.1/4"	-

OMP-tea pilet lavamani



Kodi	Përshkrimi	Cmimi
8530.360.5	TEA-Pilet lavamani bronxi i kromuar Klik-Klak fi 63x1.1/4"	-

OMP-tea pilet banjo



Kodi	Përshkrimi	Cmimi
2565.401.8	TEA-Pilet banjo me dalje anesore rrotulluese fi 50	-

OMP-tea pilet banjo



Kodi	Përshkrimi	Cmimi
263.201.8	TEA-Pilet banjo me dalje fundore fi 50&zgare inoksi	-

OMP-tea pilet banjo



Kodi	Përshkrimi	Cmimi
265.201.8	TEA-Pilet banjo me dalje anesore fi 50&zgare inoksi	-

OMP-tea pilet banjo



Kodi	Përshkrimi	Cmimi
267.201.8	TEA-Pilet banjo me 1 dalje anesore fi 50&zgare inoksi	-

OMP-tea pilet banjo



Kodi	Përshkrimi	Cmimi
2665.491.8	TEA-Pilet banjo Tirana e sheshte fi 50 me zgare inoksi katrore	-

OMP-tea pilet pllake dushi



Kodi	Përshkrimi	Cmimi
6261.076.6	TEA-Pilet pllake dushi e sheshte fi 50	-

OMP-tea Sifon Lavamani



Kodi	Përshkrimi	Cmimi
19.124.5.H	TEA-Sifon lavamani PVC i kromuar me pike kontrolli fi 32x1.1/4"	-

OMP-tea Sifon Lavamani



Kodi	Përshkrimi	Cmimi
26.924.5.H	TEA-Sifon lavamani PVC i kromuar fi 32x1.1/4"	-

OMP-tea Sifon Lavamani



Kodi	Përshkrimi	Cmimi
916.334.5.K	TEA-Sifon lavamani Maomao ,bronxi i kromuar& pike kontrolli fi 32x1.1/4"	-

Panele Dielllore

Ngrohje & Ftohje

Hidraulike

Hidrosanitare

Aksesore të ndryshëm

SPEK®

Μηχανισμός αέρος



ΜΗΧΑΝΙΣΜΟΙ ΑΕΡΟΣ

ΦΛΟΤΕΡ

ΣΙΦΟΝΙΑ

ΚΑΛΥΜΜΑΤΑ

ΚΑΖΑΝΑΚΙΑ

ΜΠΑΝΙΟ

ΛΑΣΤΙΧΑ

ΔΙΑΦΟΡΑ

SPEK- Aksesorë

Spek-Mekanizem ajri No.1 me DA+buton



Kodi	Përshkrimi	Cmimi
31000	Inox	-

Spek-Mekanizem ajri No.1 me DA+buton



Kodi	Përshkrimi	Cmimi
37016	i bardhe	-

Spek-Mekanizem ajri me DA+buton



Kodi	Përshkrimi	Cmimi
37017	i bardhe	-

Spek-Mekanizem ajri me DP+buton



Kodi	Përshkrimi	Cmimi
31069	Inox	-

Spek-Mekanizem ajri me DP+buton



Kodi	Përshkrimi	Cmimi
37005	Inox	-

Spek-Sifon lavamani plastik



Kodi	Përmasat	Cmimi
41416	fi 32x1.1/4	-

Spek-Galixhan me valvul 1/2 plastik



Kodi	Përmasat	Cmimi
62145	fi 1/2 plastik	-

Spek-Galixhan me valvul 1/2 bronxi



Kodi	Përmasat	Cmimi
62136	fi 1/2 bronxi	-

Spek-Buton No.1 për mekanizem kasetë



Kodi	Përshkrimi	Cmimi
10100	i kromuar	-

Panele Diellore

Ngrohje & Ftohje

Hidraulike

Hidrosanitare

Aksesore të ndryshëm

SPEK- Aksesorë

Spek-Buton No.2 për mekanizem kasetë



Kodi	Përshkrimi	Cmimi
10206	plastik	-

Spek-Buton No.2 për mekanizem kasetë



Kodi	Përshkrimi	Cmimi
10200	i kromuar	-

Gomin mekanizmi 2" Spek



Kodi	Përmasat	Cmimi
26008	2" Spek	-

Spek-Mbyltese valvidhe për furnizim uji



Kodi	Përshkrimi	Cmimi
14101	furnizim uji	-

Spek-Mbyltese valvidhe për shkarkim uji



Kodi	Përshkrimi	Cmimi
14100	shkarkim uji	-

Spek-Guarnicion galixhani



Kodi	Përmasat	Cmimi
14071	1/2	-





Drops Filter uji, Gote, Fishek

Drops-Filter Uji



Kodi	Përshkrimi	Cmimi
1DR10PBST100NN	Drops-Filter uji blu 1"	-

Drops-Filter Uji



Kodi	Përshkrimi	Cmimi
3DR10PBST100NN	Drops-Filter uji blu 1" me 3 pjese	-

Drops-Filter Uji



Kodi	Përshkrimi	Cmimi
2DR10PBST100NN	Drops-Filter uji blu 1" me 2 pjese	-

Drops-Filter Uji



Kodi	Përshkrimi	Cmimi
1DR7PSWST034NN	Drops-Filter uji e bardhe 3/4"	-

Drops-Filter Uji



Kodi	Përshkrimi	Cmimi
1DR10PWST100NN	Drops-Filter uji e bardhe 1"	-

Drops-Gote filtri



Kodi	Përshkrimi	Cmimi
ACTAST103NN	Drops-Gote bosh 1" per filter	-

Drops-Gote filtri



Kodi	Përshkrimi	Cmimi
ACTAST053NN	Drops-Gote bosh 3/4" per filter	-

Drops-Fishek filtri



Kodi	Përshkrimi	Cmimi
GO10PC070NN	Drops-Fishek per filter uji me qymyrguri 1"	-

Drops-Fishek filtri



Kodi	Përshkrimi	Cmimi
GO7PC70NN	Drops-Fishek per filter uji me qymyrguri 3/4"	-

Drops-Fishek filtri



Kodi	Përshkrimi	Cmimi
GEA10ANNN	Drops-Fishek per filter uji antinitrat 1"	-

Drops-Fishek filtri



Kodi	Përshkrimi	Cmimi
GEA7ANNN	Drops-Fishek per filter uji antinitrat 3/4"	-

Drops-Fishek filtri



Kodi	Përshkrimi	Cmimi
1DR10PBST100NN	Drops-Fishek per filter uji me gargare 1"	-

Panele Diellore

Ngrohje & Ftohje

Hidraulike

Hidrosanitare

Aksesore të ndryshëm



Drops Fishek ,Nipel, Celes, Stafe, Zbutes uji

Drops-Fishek filtri



Kodi	Përshkrimi	Cmimi
AM10PP20NN	Drops-Fishek per filter uji pampuk 3/4	-

Drops-Fishek filtri



Kodi	Përshkrimi	Cmimi
AM10PP60NN	Drops-Fishek per filter uji pampuk 1"	-

Drops-Fishek filtri



Kodi	Përshkrimi	Cmimi
QUE7PN060NN	Drops-Fishek per filter uji me site 3/4"	-

Drops-Fishek filtri



Kodi	Përshkrimi	Cmimi
QUE10PN060NN	Drops-Fishek per filter uji me site 1"	-

Drops-Nipel plastik



Kodi	Përshkrimi	Cmimi
ACNIN034NN	Drops-Nipel plastike filtra uji 3/4"	-

Drops-Nipel plastik



Kodi	Përshkrimi	Cmimi
ACNIN0100NN	Drops-Nipel plastike filtra uji 1"	-

Drops-Celes filtri



Kodi	Përshkrimi	Cmimi
ACCHDRNN	Drops-Celes per filter uji 3/4" & 1"	-

Drops-Stafe plastike



Kodi	Përshkrimi	Cmimi
DROPS01	Drops-Stafe plastike dopjo e bardhe	-

Drops-Stafe plastike

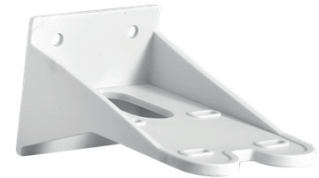

Kodi	Përshkrimi	Cmimi
DROPS02	Drops-Stafe plastike teke e bardhe	-

Drops-Stafe plastike



Kodi	Përshkrimi	Cmimi
DROPS03	Drops-Stafe plastike teke blu	-

Drops-Zbutes uji



Kodi	Përshkrimi	Cmimi
ACHXV08GNN	Drops-Zbutes uji 8 Litra	-

Drops-Zbutes uji



Kodi	Përshkrimi	Cmimi
ACHXV10GNN	Drops-Zbutes uji 10 Litra	-

Panele Dielllore

Ngrohje & Ftohje

Hidraulike

Hidrosanitare

Aksesore të ndryshëm



Drops Zbutes uji

Drops-Zbutes uji



Kodi	Përshkrimi	Cmimi
ACHXV12GNN	Drops-Zbutes uji 12 Litra	-

Drops-Zbutes uji



Kodi	Përshkrimi	Cmimi
ACHXV20GNN	Drops-Zbutes uji 20 Litra	-

Drops-Zbutes uji



Kodi	Përshkrimi	Cmimi
ACHXV30GNN	Drops-Zbutes uji 30 Litra	-

Panele Diellore

Ngrohje & Ftohje

Hidraulike

Hidrosanitare

Aksesore të ndryshëm

Sobe kaldaje druri hidraulike me furre ATS 90-30



Kodi	Fuqia	Cmimi
THER001	35.35 Kw	-

Sobe kaldaje druri hidraulike me furre ATS zero



Kodi	Fuqia	Cmimi
THER002	25.18 Kw	-

Sobe kaldaje druri hidraulike GS-W25



Kodi	Fuqia	Cmimi
THER003	25.36 Kw	-

Sobe kaldaje druri hidraulike ATS 33



Kodi	Fuqia	Cmimi
THER004	33.11 Kw	-

Sobe druri me ajer ATS zero



Kodi	Fuqia	Cmimi
THER005	17.09 Kw	-

Sobe druri ATS zero



Kodi	Fuqia	Cmimi
THER006	12.1 Kw	-

Sobe druri ATS zero



Kodi	Fuqia	Cmimi
THER007	12.42 Kw	-

Sobe druri ATS 100



Kodi	Fuqia	Cmimi
THER008	15.55 Kw	-

Sobe druri Masina Vergina



Kodi	Fuqia	Cmimi
THER009	10 Kw	-

Sobe druri Masina Vergina 90-30



Kodi	Fuqia	Cmimi
THER010	15.08 Kw	-

Sobe kaldaje druri hidraulike ATS 100



Kodi	Fuqia	Cmimi
THER011	18.19 Kw	-

Sobe ajri me pellet



Kodi	Fuqia	Cmimi
THER012	10 Kw	-

Panele Djellore

Ngrohje & Ftohje

Hidraulike

Hidrosanitare

Aksesore të ndryshëm

Panele Diellore

Ngrohje & Ftohje

Hidraulike

Hidrosanitare

Aksesorë të ndryshëm

Kalaje me pellet per brenda



Kodi	Fuqia	Cmimi
THER013	23 Kw	-

Sobe kaldaje druri me ajer ATS 30



Kodi	Fuqia	Cmimi
THER014	(20+10) kw	-

Sobe druri me ajer me furre ATS Masina 90-30



Kodi	Fuqia	Cmimi
THER015	18 Kw	-

Sobe druri me furre ATS Masina 90-25



Kodi	Fuqia	Cmimi
THER016	12 Kw	-

Sobe druri me ajer ATS 1050



Kodi	Fuqia	Cmimi
THER017	17 Kw	-

Oxhak me ajer ATS Kasetine Ballore



Kodi	Fuqia	Cmimi
THER018	13 Kw	-

Oxhak hidraulik ATS



Kodi	Fuqia	Cmimi
THER019	15.29 kw	-

Sobe kaldaje druri hidraulike me furre ATS 90-25



Kodi	Fuqia	Cmimi
THER020	20+5 kw	-

Sobe druri ATS Masina 900 Plus



Kodi	Fuqia	Cmimi
THER021	12 Kw	-

Oxhak me ajer ATS Kasetine Kendore



Kodi	Fuqia	Cmimi
THER022	14 Kw	-

Oxhak me uje ATS 80 kendore



Kodi	Fuqia	Cmimi
THER023	27.18 Kw	-

Sobe druri ATS 90-10



Kodi	Fuqia	Cmimi
THER024	12 Kw	-



THERMIKI

Sobe druri ATS 90-20



Oxhak me ajer ATS 80 kendore



Oxhak me ajer ballor ATS Stable 700 (pa ventilatore)



Kodi	Fuqja	Cmimi
THER025	16 Kw	-

Kodi	Fuqja	Cmimi
THER030	17.61 Kw	-

Kodi	Fuqja	Cmimi
THER031	13 Kw	-

Panele Djellore

Ngruhje & Ftohje

Hidraulike

Hidrosanitare

Aksesore të ndryshëm

ROTHENBERGER



Vegla pune
Rothenberg-Prese elektrike

Kodi	Përshkrimi	Cmimi
15730	Rothenberg-Prese elektrike me koke 16,20,26	-

Rothenberg-Videolog elektrik

Kodi	Përshkrimi	Cmimi
71256	Rothenberg-Videolog elektrik me koka 1/2"-2"	-

Rothenberg-Prese me baderi

Kodi	Përshkrimi	Cmimi
100002683	Rothenberg-Prese me baderi Romax 4000	-

Rothenberg-Makineri ngjitese

Kodi	Përshkrimi	Cmimi
SEH150448	Rothenberg-Makineri ngjitese per tuba PPR Ø20,25,32,40,50,63	-

Rothenberg-Makineri ngjitese

Kodi	Përshkrimi	Cmimi
SEH150449	Rothenberg-Makineri ngjitese per tuba PPR Ø75,90,110	-

Rothenberg-Set celesa anglez

Kodi	Përshkrimi	Cmimi
R175001	Rothenberg-Set me celesa anglez (6cope) 17-29	-

Rothenberg-Valixhe

Kodi	Përshkrimi	Cmimi
SET1	Rothenberg-Valixhe veglash (1300001334/73297/1000002682/1000002705/1500000151000)	-

Rothenberg-Valixhe

Kodi	Përshkrimi	Cmimi
SET2	Rothenberg-Valixhe veglash (1300001334/73297/1000002682/1000002705/15000001510)	-

Rothenberg-Set kacavidash

Kodi	Përshkrimi	Cmimi
323126	Rothenberg-Set kacavidash (6 cope+1 indicator)	-

Rothenberg-Set kacavidash

Kodi	Përshkrimi	Cmimi
73570	Rothenberg-Set kacavidash (3+3)	-

Rothenberg-Set kacavidash

Kodi	Përshkrimi	Cmimi
F090108	Rothenberg-Set me kacavida (4+4)	-

Rothenberg-Prese elektrike

Kodi	Përshkrimi	Cmimi
15730	Rothenberg-Prese elektrike pa koka	-

Panele Diellore

Ngrohje & Ftohje

Hidraulike

Hidrosanitare

Aksesore të ndryshëm

Vegla pune

Panele Dielllore

Rothenberg-Freze per hapje vrimash



Kodi	Përshkrimi	Cmimi
FF34260	Rothenberg-Freze per hapje vrimash deri 250mm, gota Ø60,80,110,130mm	-

Rothenberg-Paisje hapje vrimash



Kodi	Përshkrimi	Cmimi
1500001351	Rothenberg-Paisje per hapje vrimash per tub hidranti 1"-2"	-

Rothenberg-Sonde elektrike



Kodi	Përshkrimi	Cmimi
19173	Rothenberg-Sonde elektrike zhbllokuese per ujrart e zeza 16-22mm	-

Ngrohje & Ftohje

Rothenberg-Cante veglash



Kodi	Përshkrimi	Cmimi
402311	Rothenberg-Cant per vegla pune 370x300x395mm	-

Rothenberg-Prerese tubi



Kodi	Përshkrimi	Cmimi
402317	Rothenberg-Cante per vegla pune	-

Rothenberg-Prerese tubi



Kodi	Përshkrimi	Cmimi
70402	Rothenberg-Prerese tubi bakri Ø6-Ø22	-

Hidraulike

Rothenberg-Prerese tubi



Kodi	Përshkrimi	Cmimi
70027	Rothenberg-Prerese tubi bakri teleskopik 6-35mm	-

Rothenberg-Prerese tubi



Kodi	Përshkrimi	Cmimi
70045	Rothenberg-Paisje prerese per tub hekuri 1/8-2"	-

Rothenberg-Smusues tubi



Kodi	Përshkrimi	Cmimi
71019	Rothenberg-Smusues plastic tubash	-

Hidrosanitare

Rothenberg-Gershere



Kodi	Përshkrimi	Cmimi
52000	Rothenberg-Gershere per prerje tubi plastic 0-42mm	-

Rothenberg-Gershere



Kodi	Përshkrimi	Cmimi
52005	Rothenberg-Gershere per prerje tubi plastic 0-26mm	-

Rothenberg-Gershere



Kodi	Përshkrimi	Cmimi
568B200	Rothenberg-Gershere per prerje tubi plastic 0-42mm Eco	-

Aksesore të ndryshëm

Vegla pune

Rothenberg-Morsete mekanike



Kodi	Përshkrimi	Cmimi
R222402	Rothenberg-Morsete mekanike per tuba bakri 1/8-3/4	-

Rothenberg-Pompe Vakumi



Kodi	Përshkrimi	Cmimi
1500002663	Rothenberg-Pompe vakumi elektrike	-

Rothenberg-Mbledhese gazi



Kodi	Përshkrimi	Cmimi
1500002663	Rothenberg-Mbledhese gazi per sistem me gaz	-

Rothenberg-Pompe testimi



Kodi	Përshkrimi	Cmimi
60250	Rothenberg-Pompe testimi rrjeti TP25-25bar	-

Rothenberg-Pompe testimi



Kodi	Përshkrimi	Cmimi
60200	Rothenberg-Pompe testimi rrjeti RP50-50bar	-

Rothenberg-Cels papagall



Kodi	Përshkrimi	Cmimi
70114	Rothenberg-Celes papagall 90° Ø4''	-

Rothenberg-Cels papagall



Kodi	Përshkrimi	Cmimi
70113	Rothenberg-Celes papagall 90° Ø3''	-

Rothenberg-Cels papagall



Kodi	Përshkrimi	Cmimi
70132	Rothenberg-Celes papagall 90° Ø3''	-

Rothenberg-Celes papagall



Kodi	Përshkrimi	Cmimi
70528	Rothenberg-Celes papagall SP 45° Ø10''	-

Rothenberg-Cels papagall



Kodi	Përshkrimi	Cmimi
70161	Rothenberg-Celes papagall 90° Ø32.1/2''	-

Rothenberg-Cels papagall



Kodi	Përshkrimi	Cmimi
70162	Rothenberg-Celes papagall 90° Ø3''	-

Rothenberg-Celes papagall



Kodi	Përshkrimi	Cmimi
70228	Rothenberg-Celes papagall	-

Panele Dielllore

Ngrohje & Ftohje

Hidraulike

Hidrosanitare

Aksesore të ndryshëm

Vegla pune

Rothenberg-Celes papagall



Kodi	Përshkrimi	Cmimi
070122X	Rothenberg-Celes papagall super 45° Ø1"	-

Rothenberg-Celes papagall



Kodi	Përshkrimi	Cmimi
70545	Rothenberg-Celes papagall 90° Ø1"	-

Rothenberg-Celes papagall



Kodi	Përshkrimi	Cmimi
1000000287	Rothenberg-Celes papagall I vogel, I zi 7"-1/8-1.1/4"	-

Rothenberg-Celes papagall



Kodi	Përshkrimi	Cmimi
1000000288	Rothenberg-Celes papagall mesatar, I zi 10"-1/8-2"	-

Rothenberg-Cels papagall



Rothenberg-Celes papagall



Kodi	Përshkrimi	Cmimi
1000002705	Rothenberg-Celes papagall mesatar, I zi 10"-1/8-2"	-

Rothenberg-Cels papagall



Rothenberg-Cels papagall



Kodi	Përshkrimi	Cmimi
070123X	Rothenberg-Celes papagall Super 45° Ø1.1/2"	-

Rothenberg-Cels papagall



Kodi	Përshkrimi	Cmimi
70110X	Rothenberg-Celes papagall 90° Ø1"	-

Rothenberg-Cels papagall



Kodi	Përshkrimi	Cmimi
70131X	Rothenberg-Celes papagall 45° Ø1/2"	-

Rothenberg-Kanelle Hidraulike



Kodi	Përshkrimi	Cmimi
070132X	Rothenberg-Celes papagall Super 45° Ø1"	-

Rothenberg-Kanelle Hidraulike



Kodi	Përshkrimi	Cmimi
70134X	Rothenberg-Celes papagall 45° Ø2"	-

Kodi	Përshkrimi	Cmimi
35050	Rothenberg-Kanelle hidraulike	-

Kodi	Përshkrimi	Cmimi
35050X	Rothenberg-Sievert Kanelle hidraulike me magnet	-

Panele Diellore

Ngrohje & Ftohje

Hidraulike

Hidrosanitare

Aksesore të ndryshëm

 Vegla pune

Rothenberg-Elektroda saldimi



Rothenberg-Kallaj



Rothenberg-Fashete metalike



Kodi	Përshkrimi	Cmimi
40094	Rothenberg-Elektroda saldimi	-

Kodi	Përshkrimi	Cmimi
45257	Rothenberg-Kallaj 2mm 250gr	-

Kodi	Përshkrimi	Cmimi
31043	Rothenberg-Fashet metalike	-

Rothenberg-Flete sharre



Rothenberg-Manometra gazi



Rothenberg-Tub per manometra



Kodi	Përshkrimi	Cmimi
71213	Rothenberg-Flete sharre hekuri	-

Kodi	Përshkrimi	Cmimi
1000001426	Rothenberg-Manometra per matje gazi	-

Kodi	Përshkrimi	Cmimi
1500000026	Rothenberg-Tub per manometra gazi (3cope)	-

Rothenberg-Set thikash



Rothenberg-Set thikash



Rothenberg-Koke prese elektrike



Kodi	Përshkrimi	Cmimi
56291	Rothenberg-Set thikash per matravid 2.1/2"-3"	-

Kodi	Përshkrimi	Cmimi
70740	Rothenberg-Tavoline trekendeshe per videolog	-

Kodi	Përshkrimi	Cmimi
1000001810	Rothenberg-Koke prese elektrike 50mm pex-al-pex	-

Rothenberg-Koke prese elektrike



Rothenberg-Koke prese elektrike



Rothenberg-Koke prese elektrike



Kodi	Përshkrimi	Cmimi
1000001810	Rothenberg-Koke prese elektrike 50mm pex-al-pex	-

Kodi	Përshkrimi	Cmimi
15322X	Rothenberg-Koke prese 16mm	-

Kodi	Përshkrimi	Cmimi
15324X	Rothenberg-Koke prese 20mm	-

Panele Diellore

Ngrohje & Ftohje

Hidraulike

Hidrosanitare

Aksesore të ndryshëm

Vegla pune

Panele Diellore

Ngrohje & Ftohje

Hidraulike

Hidrosanitare

Aksesore të ndryshëm

Rothenberg-Koke prese elektrike



Kodi	Përshkrimi	Cmimi
15326X	Rothenberg-Koke prese 26mm	-

Rothenberg-Koke prese elektrike



Kodi	Përshkrimi	Cmimi
15327X	Rothenberg-Koke prese 32mm	-

Rothenberg-Paisje pastrim Brenda-jashte



Kodi	Përshkrimi	Cmimi
1500000236	Rothenberg-Paisje pastrimi brendshme-jashtme te tubave 10-54mm	-

Rothenberg-Baderi-Karikus



Kodi	Përshkrimi	Cmimi
1000001653/1	Rothenberg-Baderi&karikus per prese me baderi	-

Rothenberg-Gote per freze



Kodi	Përshkrimi	Cmimi
FF44160	Rothenberg-Gote per freze Ø160mm	-

Rothenberg-Vaj per vegla pune



Kodi	Përshkrimi	Cmimi
SEH0206	Rothenberg-Vaj per vegla pune Super-Ego 5 lt	-

Rothenberg-Map Gas



Kodi	Përshkrimi	Cmimi
SEH0246	Rothenberg-Map Gas	-

Kasete hidranti



Kasete hidranti



Kasete hidranti



Kodi	Përmasat	Cmimi
132117	Kasete hidranti e kompletuar inkaso me xham (me tub 20m 8bar 1 1/2")	-

Kodi	Përmasat	Cmimi
MBK15-CAB-ALUGL	Kasete hidranti e kompletuar me xham (me tub 30m 15bar 1 1/2")	-

Kodi	Përmasat	Cmimi
MBK15-CAB-ALUGL	Kasete hidranti e kompletuar me xham (me tub 20m 8bar 1 1/2")	-

Kasete hidranti inkaso



Fikse zjarri



Fikse zjarri per makine



Kodi	Përmasat	Cmimi
MBK05-FC-SMALL	Kasete hidranti e kompletuar inkaso pa xham (me tub 20m 8bar 1 1/2")	-

Kodi	Përmasat	Cmimi
MBK17-060PA-VR	Fikse zjarri 6 kg pluhur	-

Kodi	Përmasat	Cmimi
MBK07-SET-PYR2BIG	Fikse zjarri per makine	-

Fikse zjarri per makine



Kodi	Përmasat	Cmimi
MBK10-SET-PYR2SMALL	Fikse zjarri per makine	-

Kolone Hidranti



Kodi	Përmasat	Cmimi
MBK05 - BA - 0554	Kolone Hidranti furnizuese 3"x2dalje 2 1/2"	-

Kolone Hidranti



Kodi	Përmasat	Cmimi
KX08 - 175B - 00	Kolone Hidranti furnizuese me 2dalje-2"	-



HIDROSISTEM®
SISTEME NGROHJE & FTOHJE



www.hidrosistem.al
contact@hidrosistem.al
info@hidrosistem.al